

# **Actuncan**

## **Archaeological Project**



**Report of the ninth season**  
**2016**

**Lisa J. LeCount and David W. Mixter**



# **The Actuncan Archaeological Project: Report of the 2016 Field Season**

**Lisa J. LeCount**

Department of Anthropology, University of Alabama

and

**David W. Mixter**

Department of Anthropology, Washington University in St. Louis

Report submitted to the Belize Institute of Archaeology

May 2017



## Acknowledgements

Lisa LeCount wishes to thank the University of Alabama's (UA) Department of Anthropology for providing logistical and financial support for the Actuncan Archaeological Project this summer. Funding for Theresa Heindel's research came from a University of California, Riverside's Humanities Graduate Student Research Grant. Funding for the radiocarbon analysis was provided by a grant from UA's College Academy for Research, Scholarship, and Creative Activity (2014-58). David Mixter's expenses were off-set by donations from Elizabeth and Stephen Mixter. Carolyn Freiwald would like to thank Gabriel Wrobel for use of his GPS. We gratefully acknowledge this aid, advice and equipment. Investigations took place through the permission and generous support of the director and associate directors of the Belize Institute of Archaeology (IA), particularly Dr. John Morris. We also wish to thank the staff of the IA, especially Melissa Badillo and Sylvia Batty for their work exporting materials from Belize to the US and organizing the BAAS and RRBA.

Without fail, the Galvez and Juan families permitted us to excavate on their lands, and we appreciate their patience for any inconveniences that our work might have caused them. Chena Galvez's hospitality and excellent food sustained us through the summer, and we thank her for all her hard work and good humor. The entire Galvez family--Chena, Linda, Alfonso, Ramon, Alfonso Jr., and Gwendolyn--provided us with more than just food and shelter, but truly a home away from home. Rudy Juan was a source of valuable information as always, and we want to thank him and Dominic Juan for their continued support of our project. We were assisted in our research by many dedicated individuals from San José de Succotz. The data presented in this report was the result of local excavators whose hard work, collaboration, and enthusiasm made this field season a success. Theresa Heindel wishes to thank her excavators Santo Penados Jr. and Elmer Cocom and ayudantes Kelvin Requena and Nelson Lemus. They are excellent people and crew.

We would like to thank the fine graduate students and colleagues whose collaboration makes the research project possible. During 2016, Bobbie Simova continued her research on artifacts from Actuncan's E-Group, and Theresa Heindel continued her work on the site's agricultural systems. Taylor Lawhon undertook ceramic analysis. Douglas Kennett and his Human Paleoecology and Isotopic Geochemistry lab staff at Pennsylvania State University hosted David in November 2015. We appreciate their continued collaboration on the analysis of radiocarbon samples from the site, and David would particularly like to thank Brendan Culleton, who provided training on how to process radiocarbon samples prior to analysis. David completed his Ph.D. during the past year, and he would like to thank Lisa for her advice and constant support that greatly facilitated his research. He would also like to thank his wife BrieAnna Langlie for her dedication to a project that takes away from her own. We greatly appreciate everyone's dedication to the success of the Actuncan Archaeological Project.

*Lisa LeCount, Tuscaloosa and David Mixter, Chicago*



## Table of Contents

Acknowledgements	i
Chapter 1: The 2016 Field Season at Actuncan <i>Lisa J. LeCount</i>	01
Chapter 2: Investigating Agricultural Strategies: On-going Operation 14 Excavations <i>Theresa Heindel</i>	07
Chapter 3: Preliminary Thoughts on Ceramic and Radiocarbon Data from Actuncan's E-Group Excavations <i>Lisa J. LeCount, David W. Mixter and Borislava S. Simova</i>	21
Chapter 4: Opportunistic Survey and New Actuncan Settlement Data <i>Carolyn Freiwald</i>	43



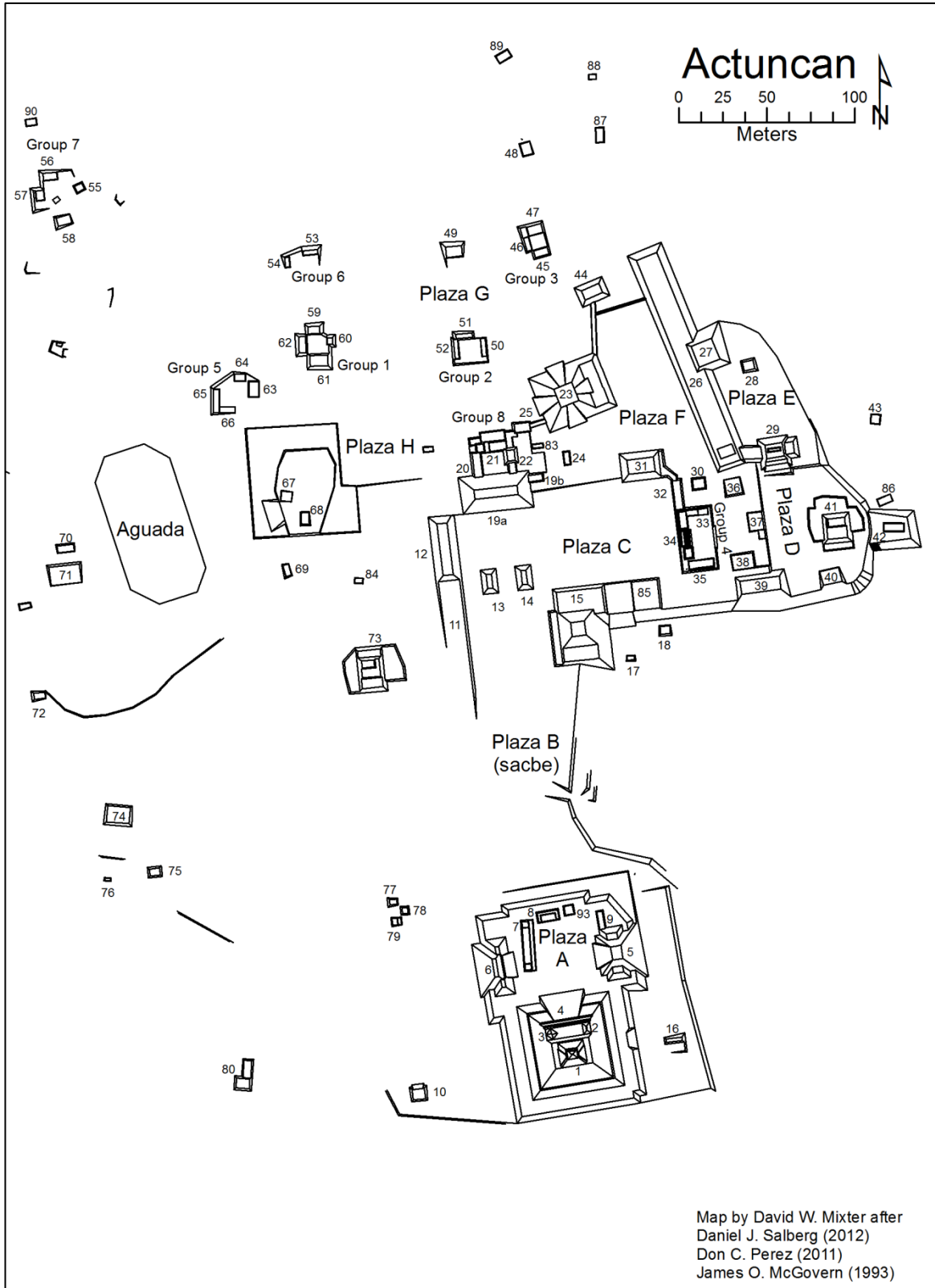

Actuncan (2017, from Mixer 2016)



## Chapter 1: The 2016 Field Season at Actuncan

Lisa J. LeCount (University of Alabama)

---

The 2016 field season at Actuncan focused on two specific questions: dating the building stages of the E-Group and understanding agricultural features in the northern settlement zone. In terms of the first question, the results of ceramic and radiocarbon dating address 1) when the hilltop was first occupied by settled peoples and 2) the timing of E-Group constructions. These two questions may or may not be related. Though the earliest construction dating to the Cunil phase of the Middle Preclassic was encountered under the eastern range of the more formal Late to Terminal Preclassic E-Group complex, the connection between these two occupations is poorly understood (Simova and Mixter 2016). More excavations are required to understand the layout of the Cunil-age structure to confirm if it is indeed an early E-Group. It could be that the early earthen mound is something else. The second question concerning agricultural features in the northern settlement zone is a continuation of research first started in 2011 with an archaeogeophysical survey and ground-truth testing (Blitz et al. 2012; Walker 2012) augmented with anomaly testing, soil sampling and chemistry, and large-scale excavations in concurrent or following years (Fulton 2015; Millar 2016; Simova 2012).

This report starts with a chapter by Theresa Heindel concerning agricultural features in the northern settlement zone. Terraces and agricultural features have always been vitally important to Belizean archaeology (Dunning and Beach 1994; Fedick 1996; Healy et al. 1983; Pohl et al. 1996), and recent research in the upper Belize River valley is no exception (Wyatt 2012). The region's high population densities required intensive farming techniques, and upland terracing was the preferred system to retain soil and channel water. According to Dunning and Beach (1994:57), the ancient Maya solved soil and water management by using stone terracing in conjunction with more archaeologically ephemeral techniques such as earthen or vegetative berms.

Heindel's excavations this summer investigated two types of agricultural features: simple stone terraces and larger terraces made of cut-stone. Simple stone terracing is the most easily understood since walls can be found and followed across the landscape using relatively shallow excavations. One of Heindel's excavations exposed a terrace initially seen on the surface. After excavation, this terrace was found to be made of multiple intersecting wall segments. Given the nature of the walls, it is likely part of a larger box-terrace field system. Dunning and Beach (1994:58) suggest that box terraces may have been seed beds or kitchen gardens given their close association with residences. Like those found at Petexbatun, Actuncan's stone terrace is found on a dry (non-irrigated) bankment associated with a residential cluster (Group 7). Further, it is above the *aguada* drainage (Figure 1.1). Intra-site surveys within the architectural core of Actuncan have found only a few stone terraces located in the northern settlement. These terraces are visible from the ground surface today, as are the cobble mounds along the western side of the Mopan River that have been mapped using a total station (Salberg 2012) and LiDAR (Chase et al. 2014) (Figure 1.2). Heindel's other excavations focused on a buried wall system made of cut-stone. After excavation, one wall turned out to be parallel walls making this wall system highly unusual. These walls could have been the head of a water control device situated between two buildings that channels water into earthen ditches or box plots terraformed out of natural *yeso* (white) clay. Currently, more excavations to expose these features are needed to interpret the system. No stone terracing of any kind has been found on the eastern slope below Actuncan's civic core; rather the T3 terrace has a gently sculptured slope that appears to have been culturally modified, as does the western slope above the *aguada* drainage.

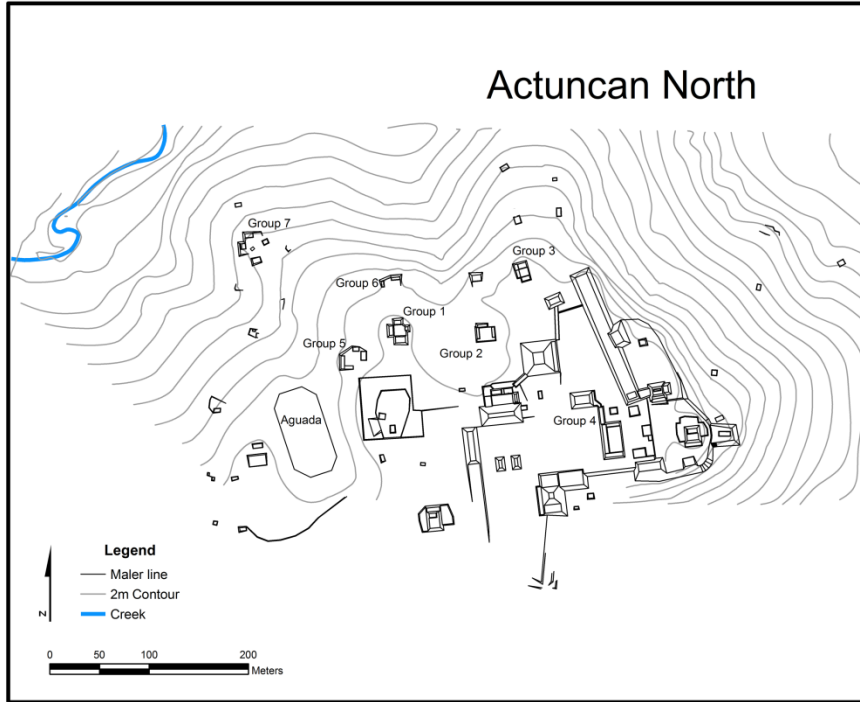

Figure 1.1. Actuncan North and its placement on the T3 terrace above the Mopan River off map to the east. Note the fact that there are few terraces on the eastern slope. Illustration by Daniel J. Salberg (2012).



Figure 1.2. LiDAR bare-earth image of Actuncan and cobble mounds near the Mopan River. Note lack of stone terracing on eastern slope above river. Illustration courtesy of Jason Yaeger (from Chase et al. 2012).

In general, terraforming is less well documented in the upper Belize River valley probably because it is more difficult to identify and trace archaeologically. Conlon (1993:198-9) reports on two types of linear indentations at the Bedran Group at Baking Pot, and he suggests they are ancient agricultural features. Type A indentations are shallow, rut-like features similar to those found at Zopilote and Zubin Groups. Type B terraforming appear as a more intensive network of ditches based on aerial photos at the Bedran Group. Conlon did not excavate the Type B terraforming features in 1992, but he surveyed their extent and measured their depths. They are between 30 and 50 cm deep. Although some appear to drain water away from fields, similar to the function of raised fields, others do not. Therefore, Conlon concluded that their functions were more complex, possibly irrigation and drainage. These indentations do not appear on slopes like those encountered at Actuncan, but may be similar in function.

At Actuncan, terraforming is documented by test excavations into magnetometer anomalies. The ground-truthing excavations revealed ditches dug into *yeso*, the local name for a dense, sterile “white” (Munsell 2.5Y 7/2-6) clay not uncommon in the upland areas of the upper Belize River valley (Scott Fedick, personal communication 2016). On the magnetometer map, the ditches appear as strong positive linear signatures that are the result of cut-and-fill features. Anthropogenic soils display markedly different magnetic signatures than sterile *yeso* clay that was cut and bermed. *Yeso* translates as gypsum or plaster, and the local *yeso* clay likely contains gypsum, a widely-mined mineral used as a fertilizer; it is also the main constituent in many forms of plaster, blackboard chalk, and wallboard (Wikipedia). Gypsum is a moderately water-soluble mineral ( $\text{CaSO}_4$  and related hydrates), which in the form of  $\gamma$ -anhydrite is used as a desiccant. In solution, its salt concentration is dependent on NaCl content. Millar (2016) encountered low berms of *yeso* perpendicular to the slope in most of her units along the western slope of the northern settlement area. Although these ditches may have acted to channel excess water away from fields, if they formed box-plots for kitchen gardens the productivity of plants sitting in soils saturated by salts and calcium sulfate would have been affected. The project has not determined the advantages or disadvantages of *yeso* ditches or berms, but the first place to start is chemical testing of Actuncan’s soils.

Chapter 3 addresses the dating of Actuncan’s E-Group including Structure 23 (the western radial structure) and Structure 26 (the eastern building). Excavations at Structure 26 have been on-going since 2012, including a test excavation in the center of the plaza (Donohue 2014; Mixter and Craiker 2013; Simova and Mixter 2016). Excavations at Structure 23 have only begun. During the 2016 summer lab season, ceramics from the excavations were examined for temporal diagnostics by Bobbie Simova and LeCount (See Table 3.A1), and LeCount continued to work on a waxy ware seriation. To date absolutely the construction stages and establish our ceramic chronologies more firmly, ten accelerator mass spectrometry radiocarbon dates were run from carbon fragments found *in situ* and from flotation samples. *In situ* carbon fragments can be scarce in Preclassic civic contexts; therefore, soil samples were taken to obtain carbon by flotation techniques. Samples from seeds and twigs with short lives can reduce the old-wood effect (Kennett et al. 2002). The ten radiocarbon essays were processed at Dr. Douglas Kennett’s Pennsylvania State University’s Accelerator Mass Spectrometry Radiocarbon Facility by David Mixter and sent to University of California Irvine’s AMS laboratory for instrumentation. These data were added to our existing C14 dates (Mixter and LeCount 2013). Chapter 3 combines radiocarbon results with the results of LeCount Preclassic pottery seriation to arrive at more precise dates for architectural episodes.

These data will help us address the second goal of the E-Group project, which is to study the geospatial modeling of centers with contemporaneous complexes within the upper Belize River valley. Although some of the existing data are not ideal for analyses, E-group excavations at Xunantunich (Brown et al.

2011) and Chan (Robin et al. 2012) located less than 4 km from Actuncan provide thoroughly excavated and precise information of construction sequences and elevations.

In Chapter 4, Carolyn Friewald reports the presence of settlement on the rolling hills above the eastern side of the Mopan River. We have always known about the numerous mounds that dot the Galvez pastures and fields since they are easily visible from the road. Based on Dr. Friewald's survey, however, larger residential groups appear to occupy the hill tops. This area is in great need of systematic survey.

### Conclusions

This year's field season was a bridge to future dissertation research by Simova and Heindel. Heindel began to trace the extent of the western field systems in the northern settlement with her excavations. The scale of the field system will require a two-pronged approach using concentrated excavations to expose the technology of soil management and water control as well as dispersed testing to document the layout and extent of the system. Simova's research will continue to focus on the relationship between E-Group remains and the earliest inhabitants of the site. Currently, Cunil-age deposits in the eastern periphery of the Maya lowlands are best understood from hilltop locations overlooking river valleys at Cahal Pech (Awe 1992; Garber et al. 2005), Xunantunich (LeCount and Yaeger 2010) and Actuncan (Mixer 2012; Simova and Mixer 2016). However, her work also includes materials and residues from the later phases of the E-Group.

### Works Cited

---

Awe, Jaime J.

1992 *Dawn in the Land between the Rivers: Formative Occupation at Cahal Pech, Belize and its Implications for Preclassic Development in the Maya Lowlands*. Ph.D. dissertation, University of London.

Blitz, John H., Ted Clay Nelson, and Daniel J. Salberg

2012 Ground Truthing Magnetic Anomalies at Actuncan. In *Actuncan Archaeological Project: Report of the Fourth Season 2011*, edited by Lisa J. LeCount and John H. Blitz, pp. 175-189. Report submitted to the Institute of Archaeology, Belmopan, Belize.

Brown, M. Kathryn, Jennifer Cochan, Leah McCurdy, and David Mixer

2011 Preclassic to Postclassic: A Brief Synthesis of the Occupation History of Group E, Xunantunich. *Research Reports in Belize Archaeology* 8: 209-220.

Chase, Arlen F. Diane Z. Chase, Jaime J. Awe, John F. Weishampel, Gyles Iannone, Holley Moyes, Jason Yaeger, Kathryn Brown, Ramesh L. Shrestha, William E. Carter and Juan Fernandez Diaz

2014 Ancient Maya Regional Settlement and Inter-Site Analysis: The 2013 West-Central Belize LiDAR Survey. *Remote Sensing* 6:8671-8695.

Conlon, James M.

1993 Corporate Group Structure at the Bedran Group, Baking Pot, Belize: Preliminary Comments on Excavations Results from the 1992 season of Investigations. In *Belize Valley Archaeological Reconnaissance Project: Progress Report of the 1992 Field Season*, edited by Jaime J. Awe, pp. 178-211. Trent University, Peterborough, Ontario.

Donahue, Luke

2014 Excavations at Structures 26 and 27 in Actuncan's E-Group. In *Actuncan Archaeological Project: Report of the Sixth Season*, edited by Lisa J. LeCount, pp. 131-154. Report submitted to the Institute of Archaeology, Belmopan, Belize.

Dunning, Nicholas P., and Timothy Beach

- 1994 Soil Erosion, Slope Management, and Ancient Terracing in the Maya Lowlands. *Latin American Antiquity* 5(1):51-69.
- Fedick, Scott L.  
1996 *The Managed Mosaic: Ancient Maya Agriculture and Resource Use*. University of Utah Press, Salt Lake City.
- Fulton, Kara Rothenberg  
2015 *Community Identity and Social Practice during the Terminal Classic Period at Actuncan, Belize*. Unpublished Ph. D. dissertation, Department of Anthropology, University of South Florida.
- Garber, James F., Jennifer Cochran, and Jaime J. Awe  
2005 Excavations in Plaza B at Cahal Pech: The 2004 Field Season. In *The Belize Valley Archaeology Project: Results of the 2004 Field Season*, edited by James F. Garber, pp.:4-41. Report submitted to the Institute of Archaeology, Belmopan, Belize, CA.
- Healy, Paul F., John D. H. Lambert, J. T. Arnason and Richard J. Hebda  
1983 Caracol, Belize: Evidence of Ancient Maya Agricultural Terraces. *Journal of Field Archaeology* 10 (4):397-410.
- Kennett, D.J., Ingram, B.L., Southon, J.R., Wise, K.  
2002 Differences in 14C age between stratigraphically associated charcoal and marine shell from the Archaic period site of kilometer 4, Southern Peru: old wood or oldwater? *Radiocarbon* 44 (1):53-58.
- LeCount, Lisa J., and Jason Yaeger  
2010 A Brief Description of Xunantunich. In *Classic Maya Provincial Politics: Xunantunich and its Hinterlands*, edited by Lisa J. LeCount and Jason Yaeger, pp. 67-78. University of Arizona Press, Tucson.
- Millar, Jane E.  
2016 Ground Truthing Magnetic Anomalies at Actuncan: The Second Season. In *Actuncan Archaeological Project: Report of the Eighth Season*, edited by Lisa J. LeCount and David W. Mixter, pp. 52-68. Report submitted to the Institute of Archaeology, Belmopan, Belize.
- Mixter, David W.  
2012 The 2011 Excavations on Structure 41. In *Actuncan Archaeological Project: Report of the Fourth Season*, edited by Lisa J. LeCount and John H. Blitz, pp. 61-117. Report submitted to the Institute of Archaeology, Belmopan, Belize.  
2016 *Surviving Collapse: Collective Memory and Political Reorganization at Actuncan, Belize*. Unpublished Ph.D. dissertation, Department of Anthropology, Washington University in St. Louis.
- Mixter, David W., and Krystal Craiker  
2013 Excavations and Sampling in Plazas C and F and Other Investigations in Group 4. In *Actuncan Archaeological Project: Report of the Fifth Season*, edited by Lisa J. LeCount and John H. Blitz. Report submitted to the Institute of Archaeology, Belmopan, Belize.
- Mixter, David W., and Lisa J. LeCount  
2013 Dating Actuncan: Contextualizing Social and Political Transitions within a Long Lived Maya Center. A paper presented at the 78th Annual Meeting of the Society for American Archaeology in the symposium *Contemporary Approaches to History and Chronology Building: Perspectives from the Eastern Maya Lowlands*, organized by Mikael Fauvelle and Valorie Aquino. Honolulu, Hawaii, April 6, 2013.
- Pohl, Mary D., Kevin O. Pope, John G. Jones, John S. Jacob, Dolores R. Piperno, Susan D. de France, David L. Lentz, John A. Gifford, Marie E. Danforth and J. Kathryn Josserand  
1996 Early Agriculture in the Maya Lowlands. *Latin American Antiquity* 7(4):355-372.
- Robin, Cynthia, James Meierhoff, Caleb Kestle, Chelsea Blackmore, Laura J. Kosakowsky, and Anna C. Novotny

- 2012 Ritual in a Farming Community. In *Chan: An Ancient Maya Farming Community*, edited by Cynthia Robin, pp. 113-132. University Press of Florida, Gainesville.
- Salberg, Daniel J.
- 2012 Mapping Actuncan during the 2011 Field Season. In *Actuncan Archaeological Project: Report of the Fourth Season*, edited by Lisa J. LeCount and John H. Blitz, pp. 25-34. Report submitted to the Institute of Archaeology, Belmopan, Belize.
- Simova, Borislava S.
- 2012 Test Excavations in Actuncan Households. In *Actuncan Archaeological Project: Report of the Fourth Season*, edited by Lisa J. LeCount and John H. Blitz, pp. 139-162. Report submitted to the Institute of Archaeology, Belmopan, Belize.
- Simova, Borislava S., and David W. Mixter
- 2016 On-going Excavations at Structure 26 in Actuncan's E-Group. In *Actuncan Archaeological Project: Report of the Eighth Season*, edited by Lisa J. LeCount and David W. Mixter, pp. 9-39. Report submitted to the Institute of Archaeology, Belmopan, Belize.
- Walker, Chester P.
- 2012 Geophysical Survey at the Actuncan Site. In *Actuncan Archaeological Project: Report of the Fourth Season*, edited by Lisa J. LeCount and John H. Blitz, pp. 163-173. Report submitted to the Institute of Archaeology, Belmopan.
- Wyatt, Andrew R.
- 2012 Agricultural Practices at Chan: Farming and Political Economy in an Ancient Maya Community. In *Chan: An Ancient Maya Farming Community*, edited by Cynthia Robin, pp. 71-88. University Press of Florida, Gainesville.

## Chapter 2: Investigating Agricultural Strategies: On-going Operation 14 Excavations

Theresa Heindel (University of California, Riverside)

My 2016 field excavations took place in the western portion of Actuncan's northern settlement zone, with Units 14P, S, and V located to the north of Group 7 and Units 14Q, R, T, U, and W located to the south of it (Figure 2.1). These excavations revealed two possible agricultural features including 1) short, sloping walls that appear heavily eroded by water drainage and 2) a stone terrace made of limestone and chert cobbles with fill on its western side. The walls may have acted to drain water away from fields, but currently our understanding of these features is limited. On the other hand, stone terraces are common in the Belize Valley and acted to retain soil, and the fill below the terrace may have reinforced it from water draining downslope. These features may reflect the different ways in which the ancient Maya at Actuncan managed water and agricultural soils, and may further address the creation, maintenance, and spatial distribution of agricultural production at the site.

### Previous Research

Previous excavations in the area were conducted by Jane E. Millar (2016) during the 2015 field season and C. Ted Nelson (Blitz et al. 2012) during the 2011 field season. Those excavations targeted magnetic anomalies identified by a 2011 gradiometer survey (Walker 2012) of the northern settlement zone – a residential district containing patio-focused groups to the north of the civic center. Millar's excavations revealed terraforming (Units 14K and M) in the western portion of the settlement. In Unit 14K, yellow clay turned to dense white clay, locally called "yeso," about 50 cm below the surface (Figure 2.2). In Spanish, *yeso* is defined as plaster, but in English is a geological term for gypsum and chalk. Best seen in the south profile of 14K, the natural clay was cut to form low berms perpendicular to the slope and redeposited behind the berms. A similar construction was found in Unit 14M (Figure 2.3), where *yeso* was found at varying levels throughout the unit, first appearing just 35 cm below surface in the northeast corner and as deep as 55 to 60 cm below surface in areas of the south profile. The dense, impermeable *yeso* stratum appears to have been cut and redeposited much like that seen in Unit 14K. Once excavations entered *yeso*, artifact densities decreased immediately. Only a single utilized flake was recovered from the berm. These excavations suggest that drainage channels were common along the western edge of the northern settlement, possibly forming a large field system associated with berms, stone terraces and other features. Here, the land gently slopes downward towards a drainage that emanates from the site's aguada.

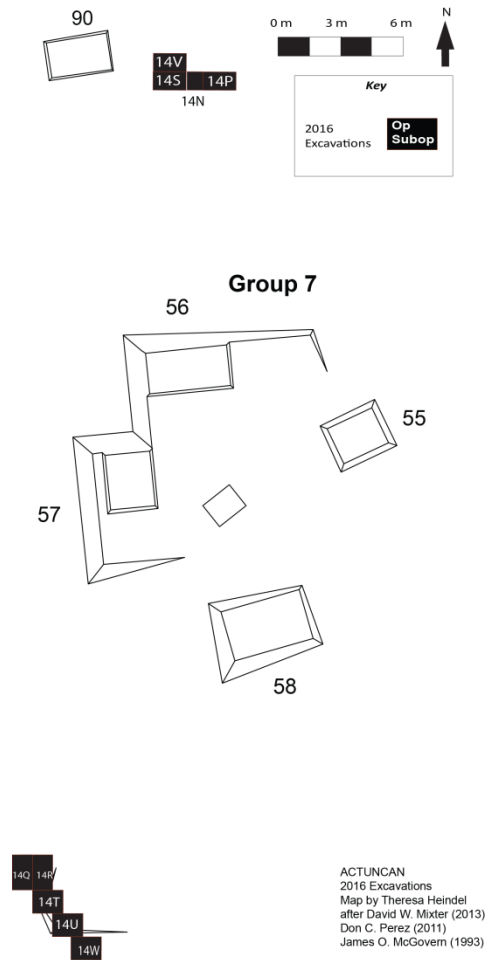

Figure 2.1. Heindel's 2016 excavations in the Northern Settlement Zone.



Figures 2.2 and 2.3. Terraforming as seen in Unit 14K (south profile) and Unit 14M (west profile) from Millar 2016.

In addition to terraforming, Millar's excavations uncovered a more complex non-domestic stone construction. In Unit 14N, a 1x1 m unit oriented north-south was laid down to investigate an interesting curvilinear anomaly between Structure 90 and a possible buried structure identified in the magnetometer data. The curvilinear signature ran roughly east to west between the two structures and perpendicular to the slope. It was hypothesized at the time to represent a terrace wall or platform edge that connected the two structures. Excavations revealed Cedar Wall (Figure 2.4), a well-constructed wall made of large cut-limestone blocks covered in plaster tilting with the slope. It appeared roughly 1m below the surface. Its outer face (the side facing downhill) met the unit profile at a 40-degree angle, sloping in the same direction as the natural topography, but at a much steeper angle, with the natural slope being between 10 and 25 degrees. The wall ran east-west across the unit and was constructed of one to three courses of stone stacked end-to-end so that their largest faces created a façade. A small fragment of a floor (Pearl) thought to be tamped *sascab* was found on the south side of the unit. After more excavation this year, we found that it was part of another wall and possibly made of plaster instead. Excavations ended when sterile *yeso* was reached on both sides of the wall, indicating that the wall sits on *yeso*. I have suggested previously that the wall was most likely agricultural in nature given its steep angle and unusual construction.

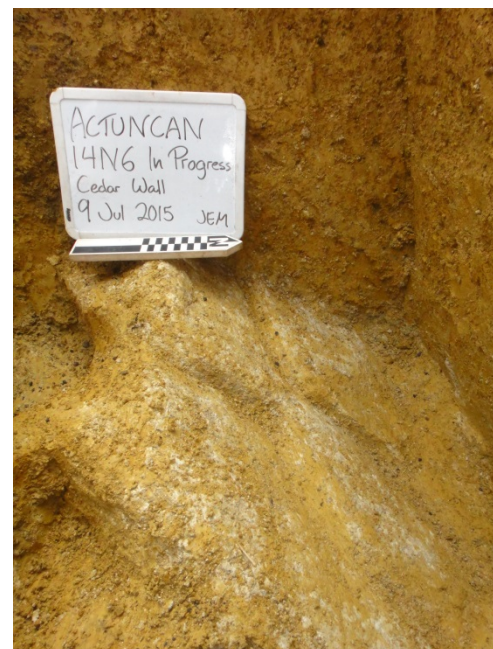

Figure 2.4. Cedar Wall as seen in Unit 14N (Millar 2016).

### Methods

The aims of the 2016 field season were to continue excavations of Cedar wall and other agricultural features seen on the ground surface in the western area of the

settlement. A total of 16 square meters were excavated to reveal and follow stone walls (Units 14 P, Q, R, S, T, U, and W). Excavation procedures followed AAP protocols. Units were excavated by natural levels. Lot changes only occurred after a soil change or the appearance of architecture. All excavated soil was sifted in a ¼" screen and later taken to the AAP lab to be stored on-site for further analysis. Several 4L soil samples were also taken for future analysis, as well as small amounts of soil collected in Whirl-Pak bags for possible microbotanical or chemical soil analysis. It should be noted that a total station was not brought into the field this year and, as such, the location of units seen in images such as Figure 1 are not exact. However, permanent datums were created for future EDMs to be taken. Datum 16 was used for Units 14Q, R, T, U and W and is located off the northwest corner of Unit 14Q; while datum 15 was used for Units 14P, S, and V and is located off the northeast corner of Unit 14P. While artifacts were washed and catalogued, no extensive artifact analysis was conducted.

### Stone Terrace

Units 14Q, R, T, U and W covered the length of a stone terrace called Stark Wall. All test pits were 1 x 1 ½ m in size with Units Q and R measuring 1 m (facing north-south) by 1 ½ m (facing east-west), and Units T, U and W measuring 1m (facing east-west) by 1 ½ m (facing north-south). Stark Wall (Figures 2.5 and 2.6) was found to be a single course of stone cobbles and limestone blocks in Units Q, R and T until it turned into five courses of stone cobbles and limestone blocks in Unit U. In total, the wall ran about 7 m in line with the natural slope of the land. It is unclear if Stark Wall continues past Unit W, as a new type of architecture was found in this test pit further discussed below.

*Unit 14Q.* Unit 14Q revealed a stone terrace wall, named Stark Wall, angling southeast from the northern sidewall. The main goal for excavating this unit was to uncover the stone terrace that had been previously identified via survey by Angela Keller as a mound with three stones in alignment on the ground surface. The unit was placed across these stones and north/northeast of the previously excavated Unit 14L. Since the total station was not available this year, the unit's exact grid coordinates are currently unknown, and its position on Figure 2.1 is based on Keller's survey map. Unit 14Q consisted of six lots, with lots Q/1 and 2 excavated to uncover both sides of Stark Wall. The remaining four lots were excavated to recover deposits and find sterile soil. Lots below Q2 consisted of natural soil with a few artifacts – a light gray clay (10YR7/2) with brownish yellow mottling (10YR6/6). This deposit was found in the northwest and northeast portion of the unit surrounding Stark Wall and was 10-15 cm thick, except in the northwest corner of the unit where it measured 50 cm thick. As it was found just below Stark Wall, it is

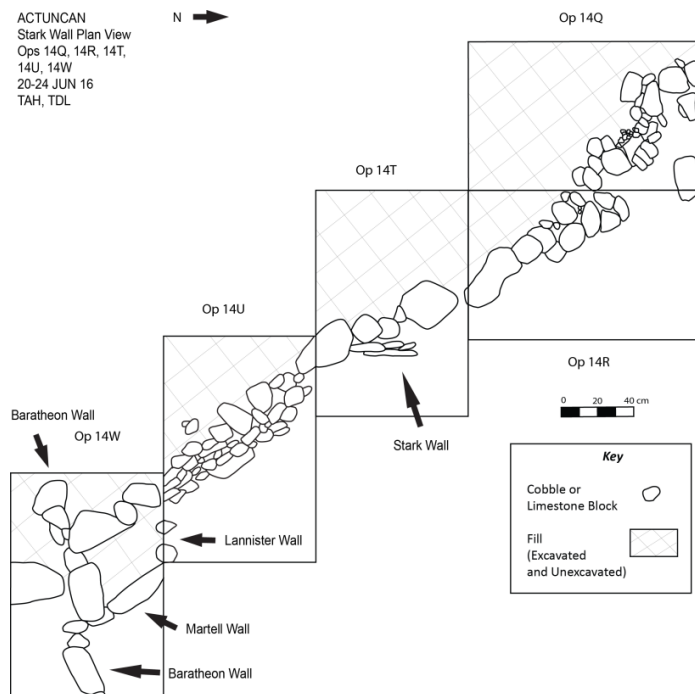

Figure 2.5. Stone terrace walls as seen in Units 14Q, R, T, U, and W. Note that Stark Wall is portrayed in elevation in Unit 14U.



Figure 2.6. Stone terrace walls in Units 14Q, R, T, U, and W.

believed that the artifacts within the natural soil was the result of water moving small artifacts and fine sediment downslope under Stark Wall or possibly artifacts deposited there prior to the construction of the wall.

Stark Wall was first found at the northeast corner of Unit 14Q and was made largely of limestone, but it was also surrounded on both sides by chert cobbles. It was determined that the wall was most likely a stone terrace because it lay perpendicular to the slope. Interestingly, fill was found on the south / southeast side of the wall and was made up predominately of large ceramic sherds and lithics, particularly cores. Based on the presence of daub, as well as numerous types of sherds and lithics, the fill was determined to be from domestic contexts. The fill was as deep as Stark Wall with the majority of artifacts being concentrated in the humus layer (Lot Q1). Its single course of limestone blocks and chert cobbles was roughly 10 cm in height and 75 cm long and, based on cursory ceramic analysis, the fill most likely dates to the Late and Terminal Classic periods (600-900 AD).

*Unit 14R.* Unit 14R was created as an eastern extension of Unit Q to follow Stark Wall that angled southeast from the unit's northern sidewall. In addition, the unit was also excavated to find out what was to the northeast of the wall since the majority of Unit 14Q contained fill materials west of the wall and little soil to the east of it. Unit R consisted of two lots. Lot 1 was the humus layer, which revealed Stark Wall, and Lot 2 continued to sterile soil. Stark Wall was not removed during excavation, but rather preserved. Lot 1 coincided with Lot Q1, and Lot R2 coincided with Lot Q3. Loose charcoal (sample 92) was found in the middle, western side of the unit near Stark Wall at the top of Lot 2. A small burnt area also was found in the same location deeper in Lot 2, and more charcoal (sample 93) was collected 93 cm below datum 16. Excavations stopped at grayish clay, where the amount of artifacts drastically diminished. At this point, both sides of Stark Wall were clearly revealed for the first time. In general, few artifacts were found on the upslope side of the wall, and it was determined that further excavations should focus solely on revealing the extent of the wall. It was also decided that the fill found in Lot 14Q was sufficient for later artifact analysis and, due to time constraints, uncovering of Stark Wall should be the main focus. In Unit 14R, Stark Wall consisted of two rows of stone, both consisting of chert and limestone cobbles. It is possible that these rows of stone are the result of a collapsed or sagged double coursed wall, but currently it is difficult to tell because of the informal nature of the construction. At its highest point, the wall had an elevation between 20 cm and 30 cm.

*Unit 14T.* Unit T was created to follow Stark Wall by extending Unit R to the south. The unit followed Stark Wall as it angled southeast from the northern sidewall of the unit. Unit T consisted of two lots. Lot 1 was a humus layer, and Lot 2 was fill and, in some places, natural soil. Here, Stark Wall consisted of four courses of chert cobbles and limestone blocks, measuring roughly 40 cm total in elevation. Excavations stopped once the bottom of Stark Wall was revealed (ending at dark yellowish-brown clay). To preserve Stark Wall and avoid unnecessary excavation into fill that had been found on the western side of the wall, only the east side of Stark Wall was excavated.

*Unit 14U.* Unit U was an extension of the Unit T staggered to the east from the unit's southern sidewall and was initiated to follow Stark Wall. Here, the wall consisted of five courses of chert cobbles and limestone blocks. It dropped in elevation downward from the north to the south and had a total elevation of about 60 cm. Like Units R and T, the goal was to reveal the extent of Stark Wall by only excavating the eastern portion of the unit to avoid the fill found on the downslope side of the wall. Again, excavations consisted of two lots with the humus root zone as Lot 1 and cultural deposits as Lot 2. Charcoal was found in Lot 2 in the southeast corner of the unit at about 91 cm below datum (labeled sample 95). A 4L flotation sample (sample 96) was also taken in the southeast portion of the unit at about 95 cm below datum. Gray clay appeared in the middle of Lot 2, and, as a result, another 4L flotation sample (sample 97) was taken at 99 cm below datum. In Unit U, Stark Wall averaged roughly 40 cm in elevation. It was difficult to discern how many courses of stacked chert cobbles and limestone blocks made up this portion of Stark Wall, but, based on the southern portion of the wall in this unit, I believe it was most likely five courses high. Another possible wall, named Lannister Wall, was encountered along the southern sidewall in Lot 2. It consists of two large chert cobbles and it ran at an angle slightly perpendicular to Stark Wall to the east at roughly 120-degrees.

*Unit 14W.* Unit W extended Unit U south staggered to the east. It was excavated to determine whether Lannister Wall continued or, for that matter, was even a wall at all. Again, Unit W was excavated in two lots. Lot 1 was the humus root zone, and Lot 2 the matrices below it. Lot 2 was excavated to find how far down Stark and another wall found perpendicular to it (Baratheon Wall) went, as well as to expose the walls (Figure 2.7). Lot 2 ended at 30 to 35 cm in depth and revealed Martell Wall and more of Lannister Wall. Although Baratheon Wall is perpendicular to Stark, Martell abuts Lannister. It is unclear if Stark Wall continues south past Unit W. Only one large limestone block appeared past Baratheon Wall. Future excavations will determine if Stark Wall continues or if this single limestone block marks the end of it.

The intersecting walls in the southern portion of the terrace are difficult to interpret. Lannister Wall consists of two stone cobbles located parallel to Unit W's northern sidewall, and Martell Wall consists of two stone cobbles parallel to Stark Wall (located to the east), while Baratheon Wall runs perpendicular to Stark Wall. Baratheon Wall is a single row of ten stone cobbles only a course high. Like Unit Q, the fill around all these walls is made up predominately of large ceramic sherds and large lithics, particularly cores, and it was found mostly to the south/southeast of Stark Wall. The fill can best be described as domestic based on the presence of daub and the types of sherds and lithics present. The fill goes as deep as the base of Stark Wall with the majority of artifacts concentrated in the humus layer. Fill was also found between Lannister and Baratheon Walls. It is likely that fill deposits were used as reinforcement for the stone terrace against downslope erosion. The confluence of small walls in



Figure 2.7. Terrace wall feature in Unit 14W.

this area might signal a special agricultural feature or the abutment of multiple terraces, possibly built at different times or by different people.

### Buried Walls

Excavations resumed north of Group 7 between Structure 90 and a possible buried structure identified in the magnetometer data. The goal of these excavations is to better understand the *yeso* terraforming in the area and Cedar Wall, a sloping terrace wall found by Jane Millar in Unit 14N during the 2015 AAP field season. The façade of Cedar Wall, as well associated ones in Units 14S and 14V excavated this year face downslope and angle inward towards the slope. Water likely would have been caught between these walls and carried west-northwest. As will be discussed further in the preliminary conclusions section, I believe that the construction and placement of these walls suggest this structure may have been a water drainage system.

*Unit 14P.* Unit P abutted the eastern sidewall of Millar’s Unit 14N (Figure 2.8), which had been cleaned of backfill at the beginning of the season. Cedar Wall lay in the middle of her 1 by 1m unit with the wall continuing into the western profile. Unit 14P was created to determine whether the wall, originally thought of as a stone terrace, connected to a buried structure to the southeast. Unit 14P was excavated in seven lots. Lots 1-5 were excavated to find the top of Cedar Wall, which according to Millar’s excavations should have been about 1 m below the surface. When Cedar Wall was not found, we excavated down to sterile soil, which occurred around 130 cm below surface.

The stratigraphy encountered in Unit P was very similar to that seen in 14N with a large amount of yellow and mottled clay fill with a fairly soft texture and very few artifacts. While no structural elements were found, Unit P was still excavated down to and though 5-10 cm of *yeso*. Because no structures were found and the *yeso* contained only a few artifacts, it was decided that excavations should stop. It is unclear how far down the *yeso* layer goes.

*Unit 14S.* Unit 14S was created as a western extension to Unit 14N in the hopes of uncovering more of Cedar Wall. Unit S had strata similar to Op14N, but excavations ended at the beginning of the *yeso* layer between 100 and 120 cm below surface.

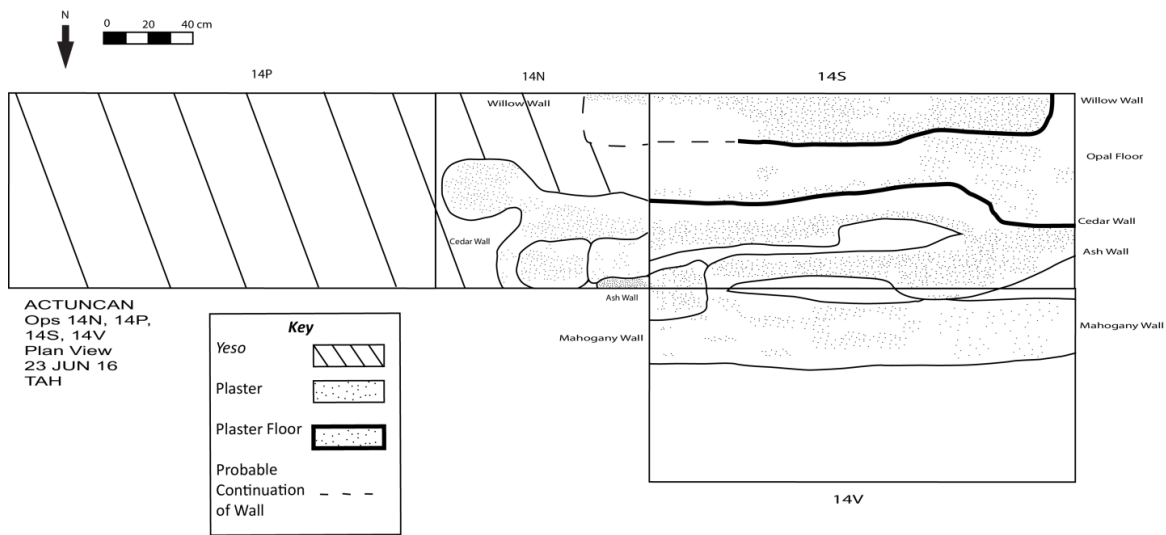

Figure 2.8. Buried walls and floors in Units 14P, N, S, and V.



Figure 2.9. Buried walls in Units 14N, V and S facing southeast.



Figure 2.10. Buried walls in Units 14N, V and S facing north.

Unit 14S was excavated in four lots. Lot 1 was the humus root zone, Lot 2 was light brown clay with many small (0-1 cm) limestone inclusions, and Lot 3 was found to be yellow, soft clay fill. The presence of six human tooth fragments, one complete human molar and nine shell beads suggests it may have contained a burial or cache. The teeth did not show any evidence of roots and, as such are likely from a small child or infant who did not have their adult teeth. No analysis has been conducted on these teeth yet. It is unclear as to whether they represent a tooth cache, or if the teeth are the sole remains of a child burial since child and infant bones are rarely preserved in acidic soil. The shell beads have not been analyzed and, as a result, it is unclear what species these shells belong to. The teeth were found around 92 cm below datum (74 cm from the eastern sidewall and 10 cm from the northern sidewall), while the beads were found about 89 cm below datum (79 cm from the eastern sidewall and 61 cm from the northern sidewall). Fragments of plaster suggestive of Cedar Wall or another construction were found 10-15 cm below the human teeth and shell beads. It is unclear what the connection (if any) there is between the possible cache or burial and the architecture below it.

More of Cedar Wall was revealed in the yellow soft clay of Lot 4, and a 4 L soil sample (sample #98) was taken in front of the northwest portion of it and along the northern sidewall of the unit for further analysis. Excavations also revealed another wall, Willow, the top of which we originally thought was Millar's Pearl Floor. The remnants of a new plaster floor, Opal, were also found between Willow (located to the south) and Cedar (located to the north) Walls, so the area was left unexcavated. Our excavations found that Cedar Wall was broken in two different directions. Therefore, it was divided into Cedar (found in the middle wall of Unit S and continuing into Unit N) and Ash (found going into the northern sidewall of Unit S) Walls. As in Unit N, all walls appear to sit atop the *yeso* layer.

*Unit 14 V.* Unit V was created as a northern extension of Unit S to determine how far north Ash Wall went and if any other walls could be found. The unit consisted of five lots with stratigraphy resembling that found in Unit S directly south. A possible posthole was found below the humus root zone (Lot 1) in the southwest corner of the west sidewall in Lot 2 at about 25 cm below surface. This 25 cm (facing north-south) by 20 cm (east-west) posthole appears to have been the bottom of the post mold. It terminated just above the soil stratum that covered Cedar, Ash, and Willow Walls, thus postdating the construction. The entirety of the posthole (excavated as Lot 3) was between 20 and 25 cm deep. Excavations then continued into the yellow soft clay fill also found in Unit S at this level just above the

appearance of architecture. The northern end of Ash Wall and a new wall to the north, Mahogany, were found between 75 and 85 cm below surface and continued down to the *yeso* layer. Mahogany Wall started at the south sidewall of Unit V and continued north for 40 cm and, like Ash Wall, continued into the west sidewall of the unit. Excavations did not excavate into the walls, but that will be a goal for future excavations. Based on the general surface appearance, however, it appears that the walls were made of blocks of plaster, which have now become heavily degraded (Figures 2.9 and 2.10).

### Analytical Units

The following section describes the individual analytical units defined in Units 14P through W. The descriptions are separated into two main constructions: 1) Stark Wall terrace (with Lannister, Baratheon, and Martell connecting walls) as seen in Units 14Q, R, T, U, and W and 2) Cedar Wall (with Willow, Ash, and Mahogany Walls and Opal Floor) as seen in Units 14P, S and V. A table of analytical units and their corresponding lots can be found in the appendix, as well as a Harris Matrix linking them together (Figure A.1).

#### *Stark Stone Terrace*

*Stark Wall Humus and Fill – AU1. Lots Excavated: 14Q, R, T, U, and W/1.* This analytical unit describes modern soil development (humus layer), as well as (presumed) Terminal Classic domestic fill mixed within the humus layer. The matrix was a very dark grayish brown (10YR 3/2) clay loam humus that ranged between 10 and 50 cm thick depending on the slope found in the five different units. Areas with a deeper humus layer included construction fill that contained a substantial amount of large sherds and cores, as well as chert cobbles and undressed limestone inclusions, ranging between 0-50 cm in size. Stark Wall was located in the lower layer of humus that contained fill. The fill, located to the west of Stark Wall, was likely used to support the wall and prevent it from toppling when water ran downslope. In addition, it is likely that the fill was created from domestic refuse due to the amount of sherds and cores. Based on its depth and preliminary ceramic investigation, AU1 probably dates between the Late and Terminal Classic time periods.

*Stark Wall Fill – AU2. Lots Excavated: 14Q/2.* The matrix was a brown clay (10YR 4/3) loam located below the humus layer at the same level as Stark Wall and was roughly 20 cm thick. The same large artifacts and cobbles seen in the Lot Q1 fill (i.e. AU1) was found in AU2, as well as chert cobbles and undressed limestone ranging from 0-25 cm in size. It should be noted that this fill was not found in all of Lot Q2, but only the southern half of the unit. The northwest corner did not have any fill layer. At the bottom of the fill, the soil changed to brown clay and gray mottled clay.

*Stark Wall Fill and Natural Soil – AU3. Lots Excavated: 14Q/3; 14R, T, U, W/2.* This analytical unit was comprised of a dark yellowish brown (10YR4/6) clay between 20 and 50 cm thick. Thickness was highly variable based on where the humus layer ended directly above it and the location of fill in the unit. The fill in this analytical unit was similar to the fill found in AU1 and AU2 with sherds and cores, and inclusions of 0-10 cm in size, but artifacts were far less prevalent. The bottom of Stark Wall was revealed in this analytical unit.

*Gray Soil under Stark Wall – AU4. Lots Excavated: 14Q/4.* This was a matrix of light gray (10YR7/2) clay mottled with brownish yellow (10YR6/6) clay found surrounding Stark Wall in the northwest and northeast portion of Unit Q. The clay was between 10 and 15 cm thick, except in the northwest corner of Unit Q where it was about 50 cm thick. Very few artifacts were found, and it appears that the clay was built up from natural soil deposited from water draining through and around Stark Wall.

*Brown Soil under Stark Wall – AU5. Lots Excavated: 14Q/5; Q/6.* This analytical unit consists of a dark yellowish brown (10YR4/6) clay roughly 40 cm thick. The majority of the AU was natural soil with only a few artifacts. It was located below the fill of Stark Wall and associated matrix.

#### *Buried Walls*

*Humus above Drainage System – AU6. Lots Excavated: 14P, S and V/1.* The humus consists of a dark brown (10YR3/2) clay loam that contained undressed limestone inclusions between 0 and 1 cm in size. The layer was between 20 and 40 cm thick.

*General Occupation above Drainage System – AU7. Lots Excavated: 14P, S and V/2.* This analytical unit consists of a mottled light brown (2.5Y4/4) clay with small (0-1 cm) undressed limestone inclusions. It ranged between 10 and 20 cm thick.

*Posthole – AU8. Lots Excavated: 14V/3.* Below 14V/2, a very dark grayish brown (10YR3/2) clay loam, similar to the humus layer above it, filled a hole in the southwest corner of Unit V. The posthole continued into the southwest corner of the west sidewall of Unit V. The bottom of the posthole was placed just above the soil stratum that covered Cedar and Mahogany Walls (see AU11). This analytical unit was between 20 and 25 cm thick.

*Fill above Buried Walls – AU9. Lots Excavated: 14P and S/3; P/ 5 and 6; 14V/4.* This layer consists of a yellow (2.5Y5/6 and 2.5Y6/6) soft clay fill between 10 and 70 cm thick with Unit P containing the thickest stratum (50-70 cm). The fill was located between the general occupation layer (AU7) and the soil stratum located above the walls (AU11), which might be part of a drainage system (AU11). In addition, this was the layer in which the teeth and shell beads were found in Lot S/3.

*Red Clay Feature above Buried Walls – AU10. Lots Excavated: 14P/4.* This analytical unit contains mottled reddish (7.5YR5/6) clay down to about 50 cm. Located 70 cm east of Unit 14P's western sidewall and 65 cm south of the northern sidewall, it was only found in the northwest corner of the unit and may have resulted from some kind of burning event.

*Soil or Fill Covering Buried Walls – AU11. Lots Excavated: 14S/4; V/5.* This matrix consisted of yellow (10YR8/6) soft clay fill between 15 and 65 cm thick depending on where the tops of the walls of the possible drainage system were discovered. The layer covered Willow, Cedar, Ash, and Mahogany Walls and Opal Floor. It contained very few artifacts.

*Yeso Associated with Buried Walls – AU12. Lots Excavated: 14P/7.* This layer contains very soft and smooth white (10YR8/1) clay that has been identified as containing a large quantity of gypsum. No walls were found in Unit 14P and, as a result, the *yeso* was excavated to find sterile soil. It is believed that the walls of the possible drainage system sits atop the *yeso*. As it was decided that excavations should stop after about 5-10 cm of excavations into this clay, so it is unclear as to how far down this analytical unit goes.

### **Preliminary Conclusions**

Excavations this year took place in the western portion of Actuncan's northern settlement zone with Units 14P, S, and V located to the north of Group 7 and Units 14Q, R, T, U, and W located to the south of it. Units 14P, S, and V investigated a buried wall, and Units 14Q, R, T, U, and W attempted to uncover the length of a stone terrace called Stark Wall. Running about 7 m in length and perpendicular to the natural slope of the land, Stark Wall consists of a single row of stone cobbles and limestone blocks in Units Q, R, and T, which then turns in five courses of stone cobbles and limestone blocks in Unit U. It is unclear if Stark Wall continues past Unit W because a new type of architecture was found there. Here, three walls (Lannister, Martell, and Baratheon) converge at the end of Stark Walls to create a possible agricultural feature. The three walls appear to form a small box; however, Baratheon Wall continues at a right angle to Stark Wall to run east-west. It could be that Baratheon and Stark Walls are part of a

larger field system, and the small box is some kind of field marker, control point, or other agricultural device. It is interesting to note that the ancient Maya might have used domestic trash to buttress the walls because fill, made up predominately of large ceramic sherds and large lithics, was found to the south-southeast of Stark Wall. The fill is as deep as Stark Wall, and was also found between Lannister and Baratheon Wall. It is likely that this fill was used as reinforcement for the stone terrace against downslope water erosion.

Based on the size of the site of Actuncan, and the type of terracing found at the site so far (particularly the stone terrace structure of Stark Wall), I believe the best comparison to the stone terrace found in 2016 would be to those found at Chan, Belize. In terms of size, while not entirely uncovered, Stark Wall appears to be much smaller than the average length and height of the terraces analyzed by Wyatt (2008) at Chan. According to Wyatt (2008:113), terraces at the site had a maximum height of 1.16 m and a minimum height of .65 m, and a maximum length of 85 m and a minimum length of 53 m. In contrast, the maximum height of Stark Wall is 10 cm and its minimum height is 40 cm, and as of the most recent excavations, measures 7 m long. In addition, the terraces found at Chan were connected as terrace sets – multiple terrace walls that formed a larger terrace structure. Terrace sets have not been found at Actuncan, yet. The construction of the stone terraces found at Chan and Actuncan seems to be similar; informal courses of river cobbles and limestone blocks were created to block water draining downslope. The time scale is much greater at Chan, however, because Chan’s terraces were constantly added to throughout the history of the site. They consist of many more courses than Actuncan’s stone terrace – making them much higher – and thin floors were created as divisions between different courses. At Chan, the construction techniques of its 392 terrace sets varied widely with some being better maintained than others. The courses making up Stark Wall, however, look more like the better maintained terraces seen at Chan. It should be noted, however, that this may be due to a variety of factors, including preservation at Chan versus Actuncan and the deep time depth of terraces at Chan. The addition of fill to stabilize a terrace wall like that found down slope of Stark Wall, however, is unique to Actuncan, and suggests a difference in maintenance. Whereas the residents of Chan chose to create higher terraces, those living at Actuncan chose to keep terraces low but reinforced with domestic fill. This difference is likely a result of human agency, environmental differences, steeper slopes, and time scale. The terraces created at Chan were usually placed on what would be termed “gentle” or “moderate” slopes, ranging between 10 to 27 degrees, while the slope at which Stark Wall is situated is about 9 degrees – still in the “very gentle” range (Wyatt 2008:113).

The buried walls at Actuncan point to a possible drainage system to the north of Group 7. These walls were excavated to *yeso*, a natural soil made of gypsum on which all architectural features in the system were constructed upon. Unit 14S contained highly disintegrated plaster walls and a plaster floor, and Unit 14V contained two additional walls. What was previously identified as Opal Floor in Unit 14N was actually another wall, renamed Willow. All walls of the possible drainage system sloped at approximately a 40-degree angle with the natural topography. Few artifacts were found in association with the walls, but above Cedar Wall in Unit 14S, six human teeth fragments and one complete molar belonging to an infant or child and nine shell beads were found. A posthole was also found above the teeth and beads’ suggesting the drainage system was used for an extended period of time.

I suggest that the buried walls and floor found in this area were part of a drainage feature designed to carry water downslope. The reasons I say is four fold. First, the walls are relatively short (around 30 cm tall); second, the angle of the walls tilt steeply; third, the walls and floor slope down along with the topography, and fourth, the *yeso* acts to channel water since it is impermeable. It has been shown that the ancient Maya employed many types of agricultural features to protect soil beds against erosion and

control water fluctuation throughout the year and from year-to-year (Beach et al. 2002; Beach et al. 2005). Based on the downslope position of the architecture and the sloping of the walls, it is likely that the walls could catch water draining downslope and transport this water to an as-of-yet unknown tank or field system. This is further suggested by the height of the walls which, while heavily eroded, were likely not taller than the 30 cm they are now. If this indeed the case, they are not representative of any substantial fallen structure. In addition, excavations conducted by Millar (2016) indicate that the *yeso* on which the walls and floor sit was used to create berms for earthen terrace structures. *Yeso* is made primarily of gypsum, and would have prevented water from permeating the berms thus trapping and channelizing water. Further, LeCount suggests that the natural *yeso* stratum would have created an impermeable clay barrier under the fields on the hill top. As rain water percolated downward through the soil, the *yeso* layer would have impeded the filtration of water and shunted it along its surface to the edge of the hill above the drainage. There, it could be caught and channelized to box terraces or tanks. While time did not permit the excavation of walls to the west, I believe future excavations may show a connection between this possible drainage system and Structure 90 located to the west.

It is unclear what connection, if any, there was between the buried wall system and the teeth and shell beads. This cache (or possibly burial) was found well above the walls of the drainage system, and may have been placed in remembrance of the water flowing through the system. Alternatively, it could represent a ritual unassociated with the buried system. However, I would suggest this second possibly was still connected to water, as water would have continued downslope towards the area. The purpose of the posthole is also unclear, but, as it comes from a later time (most likely Late or Terminal Classic based on its depth) than the drainage system, it is likely from a separate, later wooden structure.

#### **Acknowledgements:**

First, I would like to thank the UC-Riverside Center for Ideas and Society for their Humanities Graduate Student Research Grant, which provided me the ability to conduct this research. A huge thanks also goes out to Lisa LeCount for all of her help and support. Her guidance was instrumental to these excavations and my entire work at Actuncan, and I cannot express my gratitude enough. I would also like to thank David W. Mixter, whose suggestions have greatly helped with my understanding of these excavations, and who provided maps for this report. Borislava Simova, Taylor Lawhon, and Carolyn Freiwald have also been a huge help both in the lab and in the field, and I want to thank them for that, as well as for keeping things lively during the field season. I also want to thank my dedicated excavators and ayudantes---Elmer Cocom, Nelson Lemus, Kelvin Requena, and Santos Penados Jr.---who made every day a fantastic learning experience and worked so hard to get as much work done as possible in such a short amount of time. Finally, a thank you also needs to go to Azucena Galvez—an amazing woman who makes our time at Clarissa Falls so enjoyable.

#### **Works Cited**

---

- Beach, T., Dunning, N., Luzzadder-Beach, S., Cook, D.E., and J. Lohse  
2006 Impacts of the ancient Maya on soils and soil erosion in the central Maya Lowlands. *Catena* 65:166-178.
- Beach, T., Luzzadder-Beach, S., Dunning, N., Hageman J., and J. Lohse  
2002 Upland agriculture in the Maya Lowlands: ancient Maya soil conservation in northwestern Belize. *Geographical Review* 92: 372-397.
- Blitz John H. Blitz, Ted (Clay) Nelson, and Daniel J. Salberg

2012 Ground Truthing Magnetic Anomalies at Actuncan. In *The Actuncan Archaeological Project: Report of the 2011 Field Season*, edited by Lisa J. LeCount and John H. Blitz, pp. 172-186. Report submitted to the Institute of Archaeology, Belmopan, Belize.

Millar, Jane E.

2016 Ground Truthing Magnetic Anomalies at Actuncan. In *The Actuncan Archaeological Project: Report of the 2015 Field Season*, edited by Lisa J. LeCount and David W. Mixter, pp. 52-68. Report submitted to the Institute of Archaeology, Belmopan, Belize.

Walker, Chester P.

2012 Geophysical Survey at the Actuncan Site. In *The Actuncan Archaeological Project: Report of the 2011 Field Season*, edited by Lisa J. LeCount and John H. Blitz, pp. 161-171. Report submitted to the Institute of Archaeology, Belmopan, Belize.

Wyatt, Andrew R.

2008 *Gardens on Hills: Ancient Maya Terracing and Agricultural Production at Chan, Belize*. Unpublished PhD Dissertation, Department of Anthropology, University of Illinois at Chicago.

---

Appendix 2.A.

---

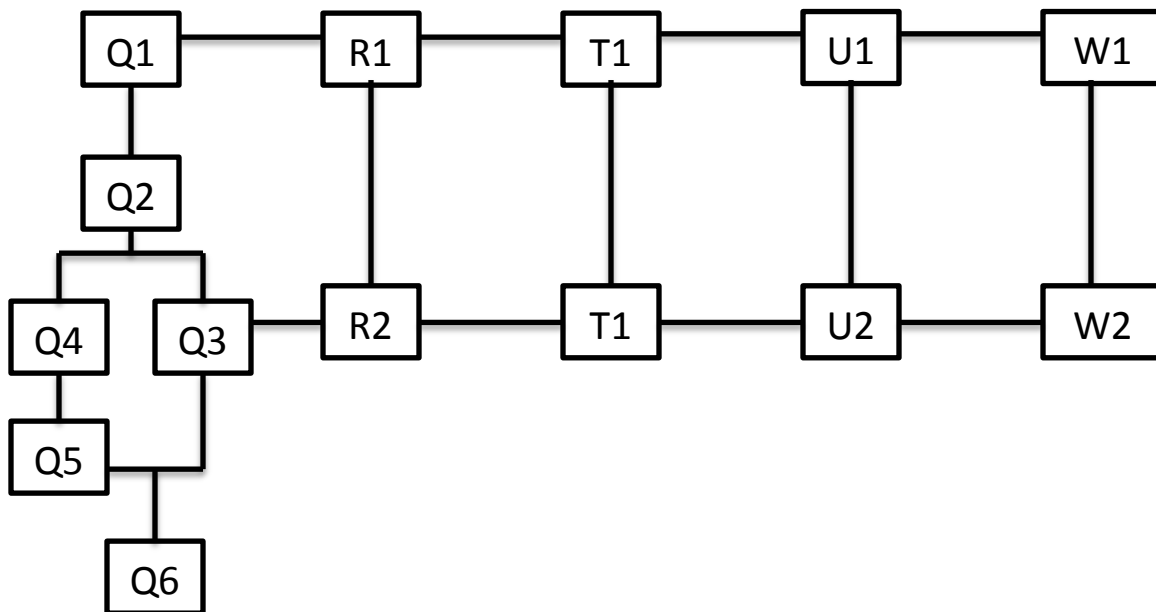

Figure 2.A.1. Harris Matrix: Units 14Q, R, T, U, and W, the stone terrace.

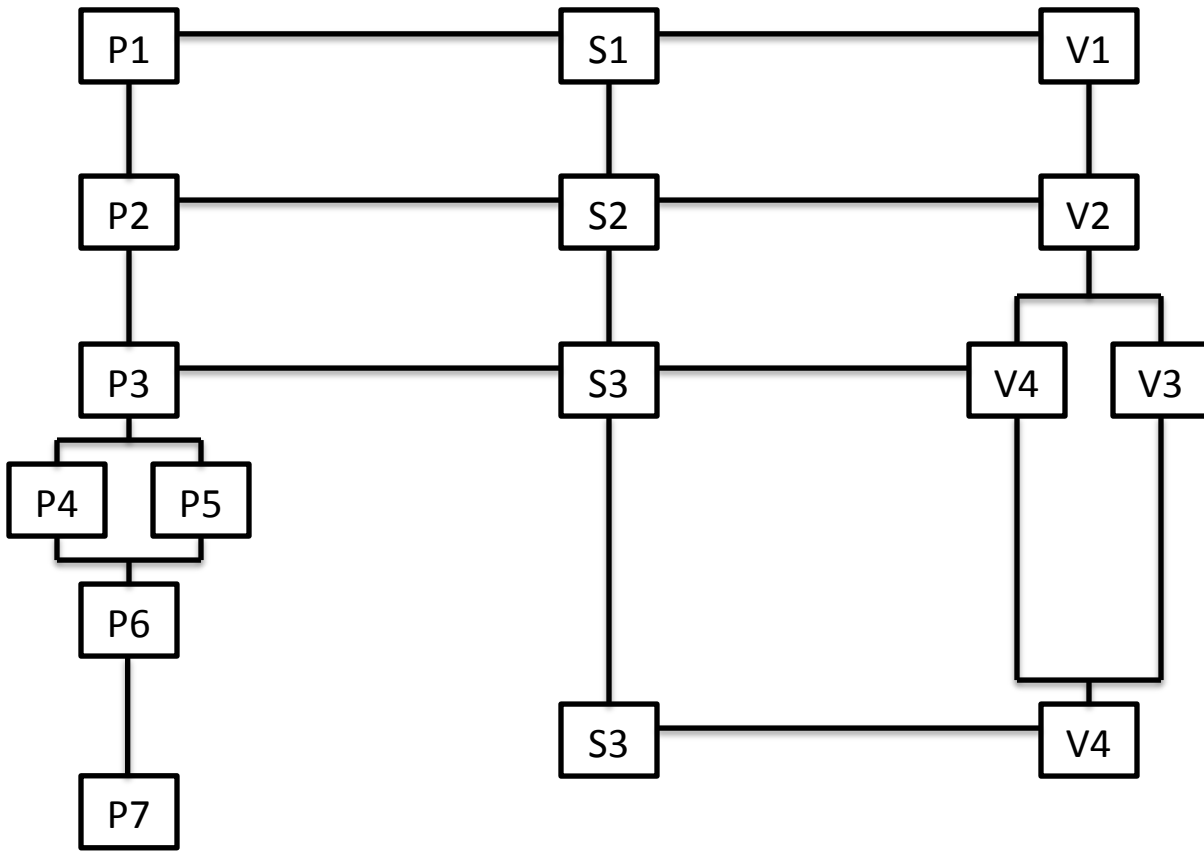

Figure 2.A.2. Harris Matrix: Units 14P, S, V, the possible Water Drainage System

Table 2.A.1. Analytical Units.

<b>AU</b>	<b>AU Name</b>	<b>Lots</b>
1	<i>Stark Wall Humus and Fill</i>	Q/1, R/1, T/1, U/1, W/1
2	<i>Stark Wall Fill</i>	Q/2
3	<i>Stark Wall Fill and Natural Soil</i>	Q/3, T/2, U/2, W/2
4	<i>Gray Soil under Stark Wall</i>	Q/4
5	<i>Brown Soil under Stark Wall</i>	Q/5, Q/6
6	<i>Humus above Buried Walls</i>	P/1, S/1, V/1
7	<i>General Occupation above Buried Walls</i>	P/2, S/2, V/2
8	<i>Posthole</i>	V/3
9	<i>Fill above Buried Walls</i>	P/3, P/5, S/3, V/4
10	<i>Red Clay Feature above Buried Walls</i>	P/4
11	<i>Soil or Fill Covering Buried Walls</i>	S/4, V/5
12	<i>Yeso Associated with Buried Walls</i>	P/7



### Chapter 3: Preliminary Thoughts on Ceramic and Radiocarbon Data from Actuncan's 2015 E-Group Excavations

*Lisa J. LeCount* (University of Alabama), *David W. Mixter* (Washington University in St. Louis) and *Borislava S. Simova* (Tulane University)

---

The goals of this chapter are to document our progress in dating Actuncan's E-Group constructions and establishing a ceramic chronology for the entire site firmly anchored in an absolute time frame. Because the E-Group yielded evidence of multiple construction stages beginning in the Cunil phase and continuing into the Early Classic period, the two goals complement each other.

Dating the multiple construction sequences of Actuncan's E-Group addresses two important questions about the development of socio-political complexity in the eastern Maya lowlands. The first concerns the initial development of public architecture. At Ceibal, Inomata and colleagues (2013) have exposed the earliest (1000 B.C.E.) known Maya E-group, a complex that later became the civic focus of many centers. Ceibal's E-group configuration closely resembles those within the Isthmian Interaction Sphere lending evidence to suggest that the western Maya participated in the development of prescribed practices and concepts that defined Mesoamerican civilization. According to Inomata (2017), in most other parts of the Maya Lowlands construction of E-Groups or other public architectural complexes lagged behind and were not built until 800 BCE or even centuries later. Evidence of a Cunil-age E-Group at Actuncan, however, complicates this interpretation. Although this is an exciting prospect, it must be said that the Cunil-age construction under Actuncan's E-Group has not been confirmed as an E-Group just yet. It might be some other kind of public architecture such as an isolated mound; however, we can say that it is not a house. Cunil-age houses did not sit on mounds; rather they sat on a scraped and leveled surface (Garber et.al 2004). Although Cunil-age deposits underneath Xunantunich A-6 may derive from an earthen mound (LeCount and Yaeger 2010:70), Actuncan yields the first good evidence of public architecture constructed in this manner at this time (Simova and Mixter 2016). We assume Actuncan is not unique in this regard and that other early public architecture will be found in the future. However, the shifting nature of early villages and their small-scale public buildings make them hard to find.

Evidence from the early public architecture within Actuncan's E-Group will inform Simova's dissertation research on Middle Preclassic social dynamics. In particular, it will be examined in reference to the convergence between landscape, people, and objects. E-Group's, as a new form of permanent inscription on the landscape, presumably represented a new materiality, both a median for and index of physical interaction that shaped future development at the site. Consequently, monumental architecture will be analyzed as a driving force, rather than a product of, social change during this time period. Research from the early E-Group of Actuncan can contribute to greater understanding of developing ceremonial practice (Estrada-Belli 2011) and community integration (Inomata et al. 2015) in the long-term development of Lowland Maya cities and civilization, in general.

The second issue is a ceramic chronology problem. The apogee of Actuncan's E-Group construction occurred during the Terminal Preclassic period, one of the most highly debated parts of James Gifford's (1976) ceramic sequence in the Belize Valley. Gifford subdivided the Late Preclassic period into three complexes (Barton Creek, Mount Hope and Floral Park) that despite continued research still remain inadequately described and dated. According to Gifford (1976:127), the Floral Park and Mount Hope complexes overlap in time during the latter part of the period, which we and many other Belizean archaeologists call the Terminal Preclassic period. He suggested that Mount Hope was a complete

complex made up of domestic and ritual pottery forms and styles that pre-dated the introduction of Floral Park pottery by a new “Protohistoric population” from El Salvador. Although the immigration model for the appearance of Protohistoric pottery styles has been rejected, these styles still occur late in the Preclassic period. Therefore, Mount Hope pottery should be found in stratigraphic order below strata where Floral Park and Mount Hope diagnostics are found together. Similarly, Culbert (1993) understood the Late Preclassic to be composed of three chronologically distinct complexes (Chuen, Cauac, and Cimi). Gifford (1976:127) claimed that the Cimi Complex was “without question a fundamentally Preclassic manifestation; it is not protohistoric” because it contains both Cauac and Holmul I styles. Defined this way, the Terminal Preclassic is NOT synonymous with the Protohistoric. We follow Brady and colleagues (1998:32) who use the term Protohistoric to describe a subset of highly eclectic pottery forms and styles. Therefore, the Protohistoric Subcomplex is not the same as the Floral Park Complex in terms of time span or composition, although people do equate them (Callaghan 2016:25).

Today, there is cautious agreement that Floral Park diagnostics appear to be wide-spread and chronologically distinct in the Belize Valley, although the relatively plain types remain challenging, especially those associated with the Aguacate Group. Although there is much disagreement about Floral Park types in terms of where they fit within the classification scheme, how to recognize diagnostic features, and the timing of their first appearance, Brady and colleagues (1998:24) confirmed the existence of an Aguacate Group with recognizable types such as Aguacate (matte) Orange and Gavilan Black-on-orange, as well as others. The Mount Hope Complex is also poorly understood and dated. Gifford (1976: 111) stated that the complex is made up of types produced in the same traditions as Barton Creek, but that the occurrence of Escobal, Sarteneja (containing Usulután styles), San Felipe, and Quacco Ceramic Groups distinguish it from the earlier Barton Creek complex. Unfortunately, these diagnostics are difficult to recognize because surface treatments and colors reference both earlier and later styles. Thankfully, there is little disagreement about the major diagnostics associated with the Barton Creek complex, the earliest of the Late Preclassic complexes. It is widely recognized as a relatively homogeneous complex made up of sturdy vessels with bold waxy red, black and cream slips and striated and unslipped plainwares. However, the transition between Barton Creek and Mount Hope is not well dated.

Given the level of ambiguity in this part of the sequence, it is in need of greater study and more precise absolute and relative dating. For the time being, we use the term “Terminal Preclassic” to describe both the Floral Park and Mount Hope Complexes because we have found that diagnostics from all three complexes (including Barton Creek) occur together in the later part of the sequence. Separating Floral Park from Mount Hope is particularly difficult in small collections since Floral Park diagnostics are rarer than waxy red or brown wares that make up the bulk of earlier complexes. Additionally, red to orange groups (Sierra, Quacco, Vaquero, and Aguacate) are only distinguishable with well-preserved rims. Our use of the term Terminal Preclassic period will change in the future as we come to understand the ceramic complexes more completely and subdivide the Late and Terminal Preclassic phases. Indeed, in situations where we have good stratigraphy and are confident about types and sample sizes we prefer to use specific complex names. But until an agreement is reached about what the Terminal Preclassic is—in terms of pottery, architecture and cultural innovations—it remains confusing and synonymous with the Protohistoric.

Currently, there are few radiocarbon dates for the transitional Preclassic complexes, but some are found in Brady et al. (1998). They divide the sequence into two stages: Protohistoric Stage 1 dated to 75±25 BC to AD 150 and Protohistoric Stage 2 dated to AD 150 to 400 ± 20 (Brady et al. 1998:35). Stage 1 is defined

by the presence of matte finished orange-brown pottery associated with Gifford's Aguacate Orange Group, and Stage 2 is defined by the presence of Ixcancio Polychrome, orange gloss wares, and mammiform feet. Brady and colleagues' two-part division appears to map onto Gifford's Mount Hope and Floral Park complexes, but the article does not provide succinct descriptions of pottery complexes or the frequencies of types and attributes within these stages so it is difficult to cleanly correlate their scheme (and radiocarbon dates) with ours. Further, they do not address the temporal boundary between Barton Creek and Mount Hope that sets the date for the diversification of waxy wares. Rather they concentrate on the other end of the sequence; in other words, the boundary between Mount Hope and Floral Park (or Holmul I and Protoclassic subassemblage). Therefore, the temporal relationships between Late Preclassic complexes and the diversification of styles continue to be a source of debate.

The project has been working to date the E-Group, specifically, and other constructions of the site more broadly using absolute dating techniques. The E-Group is particularly important in this endeavor because it has deep stratigraphy that is relatively fine-grained for a civic building. Some may ask why we bother with relative dating techniques since radiocarbon dates are becoming highly accurate. The point LeCount wants to make here is that it is impossible to do archaeology in general and absolute dating specifically without relative methods. Most archaeologists work with temporally sensitive ceramic types and attributes every day in the field and lab. Therefore they remain the most ubiquitous and cheapest way to date archaeological deposits. Radiocarbon dating is still expensive, and choosing samples for instrumentation is done after considerable time and effort has been spent documenting stratigraphy, classifying pottery, and organizing proveniences into cultural strata. Only then do we understand which samples may establish an absolute time frame for architectural, occupation or ceramic sequences. Therefore, stratigraphic analysis and ceramic seriation underpin absolute dating methods, especially today when Bayesian analysis is relied upon to determine the validity of radiocarbon dates.

### **Excavation Background**

Actuncan's E-Group is comprised of a plaza (Plaza F), an eastern platform and central pyramid (Structures 26 and 27), a western radial structure (Structure 23), and two possible north-south buildings (Structures 44 and 31). Axial trenches were placed on Structures 26 and 27 to document building stages and to expose architectural and ritual features over two field seasons (Donahue 2014; Simova and Mixter 2016). On Structure 23, preliminary excavations began in 2015 into the eastern flank opposite the Structure 26 trench (Heindel 2016). Structures 26 and 23 have received the most intensive investigations and their stratigraphy will be described in more detail below. Other E-Group elements however also have been tested. In 2011, two plaza units (31A, Q) revealed eight plaster floors in varying states of decay dating from Middle Preclassic to Terminal Preclassic periods (Mixter and Craiker 2013). Three floors date to the Middle Preclassic, two to the Late Preclassic, and two to the Terminal Preclassic, but the terminal floor was not dated due to a lack of ceramics. McGovern (2004:139-142) also placed shallow test excavations in Structure 26 near its corner with Structure 31 and Structure 26A, a low platform located on the far southern end of the summit. These excavations exposed Early Classic floors and walls, but did not penetrate them.

Currently, we know the most about Structure 26. The bulk of the mound is composed of Owl Platform. Simova and Mixter exposed six staircases and nine plastered summit floors labelled Structures 26-1<sup>st</sup> through 26-6<sup>th</sup> based on the staircases (Figure 3.1). Similarities in dressed limestone and plaster work suggest a continuous building regimen. Some variations in construction style are present however. The Structure 26-6<sup>th</sup> staircase features small, dressed limestone blocks as stair risers and lacks stone fills, having been constructed directly onto mounded clay deposits from previous constructions. Later stair

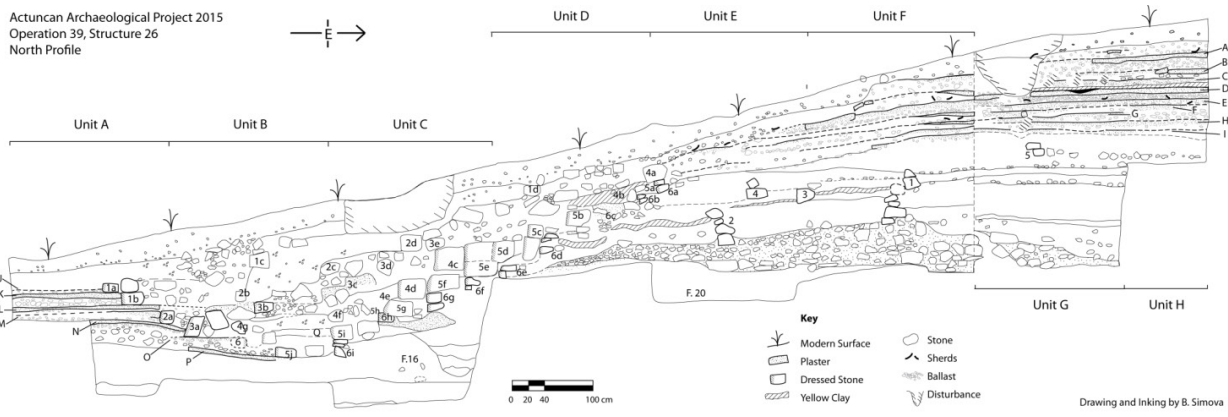

**LEGEND**

Floors	Platform Walls	Steps
A) Outkast Floor	1) Brown Jay Wall	1a-d First Staircase
B) Missy Elliot Floor	2) Warbler Wall	2a-f Second Staircase
C) Ice Cube Floor	3) Lark Wall	3a-e Third Staircase
D) Lupe Fiasco Floor	4) Robin Wall	4a-g Fourth Staircase
E) Santo Floor	5) Toucanette Wall	5a-j Fifth Staircase
F) Rene Floor	6) Quetzal Wall	6a-i Sixth Staircase
G) Luciano Floor		
H) Armando Floor		
I) Javier Floor		
J) Biggie Plaza Floor		
K) Tupac Plaza Floor		
L) Kanye Plaza Floor		
M) Fever Plaza Floor		
N) Dengue Plaza Floor		
O) Nelly Plaza Floor		
P) Felix Floor		
Q) Kelvin Floor		

Figure 3.1. North profile of Operation 39.

constructions, Structure 26-5<sup>th</sup> and 26-4<sup>th</sup>, reuse sections of stairs and incorporate larger dressed blocks as well as marl to infill sections. The Toucan staircase of Structure 26-4<sup>th</sup>, notably incorporates large, outset blocks set above the elevation of the stair, likely serving as stair blocks. Later staircase constructions, 26-3<sup>rd</sup> through 26-1<sup>st</sup>, expand the size of the structure, incorporating construction fills, rather than remodeling existing stairs with dressed stone and marl. Each staircase would have abutted specific summit floors; however, the articulations between staircases and summit floors were only preserved in the earliest two versions. Below the limestone-stone and plastered constructions of Structure 26, Simova identified two additional platforms, Structures 26-sub-1 and 26-sub-2. Structure 26-sub-1, referred to as Brown Jay Platform was buried under deposits of brown and orange clay. It was constructed in at least two phases with cobble facades and layered dirt fill relatively free of stone inclusions. The latest construction, 26-sub-1-1<sup>st</sup>, has low terraces on its western edge and the summit supported small cobble architectural elements. Structure 26-sub-2 is an earthen platform approximately one meter in height that was constructed out of redeposited clay containing artifacts. Multiple features were found, but the most important is Feature 20, a burnt offering in a jar rim (Figure 3.2b). The rim was reconstructed in the lab (Figure 3.2a) and was typed by LeCount as an Ardagh Orange-brown jar,



Figure 3.2. Ardagh Orange-brown jar rim (left) and Feature 20 (right), from Simova and Mixer 2016

very similar to another jar rim found in Structure 41 Feature 6 (Mixer 2012:92, Figure 5.16). Simova interprets this offering as a foundational deposit for the construction of the earthen mound. A large carbon sample was collected from a concentration of chunks just above the ceramic deposit. The clay below the ceramics appears to have been a tamped surface or hardened due to localized burning at the base of the earthen mound. The same type of clay was found in a thick deposit below the lowest plaza floor to the west. Our understanding of the relationships between deposits is presented as a Harris Matrix in Appendix A.

Structure 23 is a steep, oval-shaped mound. Excavations on the western flank revealed two construction phases, Structures 23-2<sup>nd</sup> and 3<sup>rd</sup>; however, excavations did not reach sterile (Heindel 2016). Nor was terminal architecture found under collapse debris. Rather, Heindel found that collapse debris sits directly on top of Structure 23-2<sup>nd</sup>, indicating that the terminal façade had either totally collapsed or was purposefully dismantled. Two staircases constructed of cut limestone were found, but again the terminal stairs are missing. A floor (Lamat) was found above the lowest known step of Staircase 2, and it appears to have been a later plastered surface associated with a low platform in front of Staircase 2.

Excavations under Structure 23-3<sup>rd</sup> revealed three floors (Muluk, Ok and Chuwen). All three floors exhibited well-preserved plaster with the last showing evidence of red pigment. Interestingly, the width of each floor suggests they were platform surfaces, not step treads. Therefore, Structure 23-4<sup>th</sup> had a very different arrangement than that which came after it, but this stage was not tested. After approximately 1.6 m, excavations ended for the 2015 season.

### **Radiocarbon Dating of Structure 26's Architectural Stages**

Radiocarbon is the standard for absolute dating; however it does have its difficulties. A sample's age can tell us when the organic material was alive but not when the material was used. This issue is called the "old wood" problem. In archaeological contexts, carbon is often found in mixed deposits increasing the chance of error. Small samples, especially from seeds and twigs with short lives can help to reduce any old-wood effect (Kennett et al. 2002). These samples can be collected through flotation techniques associated with paleoethnobotanical procedures. Dating samples from closed contexts will also more firmly link the ancient activities to the radiocarbon date.

Table 3.1. The 2015 Radiocarbon Samples from Actuncan Structure 26

Provo	Cultural Context	AU	<sup>14</sup> C age (BP)	±	Unmodelled (BC/AD)			Modelled (BC/AD)		
					from	to	%	from	to	%
39E33	Feature 20: Jar rim with burned offering	42	2895	15	-1124	-1013	95.4	-1119	-1013	95.4
39D13	Below 26-6th staircase	39	2405	20	-703 -541	-696 -402	0.8 94.6	-704 -541	-696 -402	0.8 94.6
39H34	Orange Clay Fill	29	2235	20	-381 -317	-348 -208	19.6 75.8	-304	-207	95.4
39G30	Brown Jay (lower) Fill	55	2210	20	-361	-203	95.4	-377	-271	95.4
39E19	Clay fill under Robin Wall	26	2200	20	-360 -263	-271 -200	57.5 37.9	-354	-225	95.4
39H26	Feature 8 - Posthole in Lupe Fiasco Floor	49	2120	20	-202 -77	-88 -57	90.6 4.8	-146	-50	95.4
39F11	Feature 14 - Closed pit with jars	52	2105	20	-191	-54	95.4	-197	-105	95.4
39B15	Brees Stair Fill, 26-3rd Staircase	19	2060	25	-166	1	95.4	-156	2	95.4
39H18	Feature 7 - Posthole in Outkast Floor	47	1780	15	174 212 275	192 264 330	2.3 50.8 42.4	138 212 279	193 262 324	17.3 57.0 21.1
39D17	Alvin Floor*	34	865	25	1049 1124 1150 1231	1084 1137 1226 1245	9.4 1.7 82.4 1.9			

\*rejected as an outlier, likely contaminated by modern carbon.

The Actuncan Archaeological Project collects carbon from all contexts in which it is encountered. Our paleobotanical samples derive from soil samples in which carbon is recovered with the aid of a newly built flotation tank. Funding to build the flotation tank, as well as run the radiocarbon samples from the 2015 excavations, came from a College Academy of Research, Scholarship, and Creative Activity (CARSCA) grant (2014-58), a unit of the University of Alabama's College of Arts and Sciences. The CARSCA grant provided enough funds to assay six radiocarbon samples; however, we were able to run 10 samples by sending David Mixter to prepare samples at Dr. Douglas Kennett's Human Paleoecology and Isotopic Geochemistry lab at Pennsylvania State University. After these were processed, samples were sent to the Keck Carbon Cycle AMS Facility at the University of California, Irvine for instrumentation. Uncalibrated and calibrated dates for the radiocarbon samples can be found in Table 3.1. Dates were calibrated in OxCal 4.2 (Bronk Ramsey 2009) using the IntCal13 calibration curve (Reimer et al. 2013). Bayesian modeling provides a way to combine radiocarbon dates, ceramic style dates, and stratigraphy to understand the timing of significant cultural shifts that characterize archaeological periods and phases (Bayliss 2009; Bronk Ramsey 2009; Buck et al. 1991; Culleton et al. 2012). It also aids in identifying old wood samples and other problems associated mixed contexts.

To determine which carbon samples to date, LeCount physically looked at the 67 carbon samples from Structures 23, 26 and 27, assessing their size and carbon content and rejecting samples that appeared to be dirt or modern seeds or roots. Mixter and Simova discussed which samples to run from 52 contexts containing carbon. Our goal was to date important architectural elements and features from Structure

26, as well as establish phase boundaries between the ceramic complexes. Samples from highly mixed contexts were rejected. Samples selected are listed in Table 3.1, which provides their cultural contexts, analytical units (AU), conventional ages, and unmodeled and modeled calibrated dates. The relationship of samples to architectural stages and elements can be understood by consulting the Harris Matrix for the structure (Figure 3.A.1), analytical units (Table 3.A.1), and the simplified Harris Matrix relating just the carbon samples (Figure 3.A.2) provided in the appendix.

The modelled radiocarbon results indicate that four samples (39B15; 39H18; 39H26; 39F11) date Owl Platform and its plaster floors and cut-stone staircases to the Terminal Preclassic period from roughly 200 BC to ~AD 300. This range is to be expected given our knowledge of site dynamics, style of architecture and the presence of diagnostic ceramics from multiple architectural elements. Three samples (39E19; 39F25; 39H34) date Structure 26-sub-1 (Brown Jay Platform) and its cobble architecture to the Late Preclassic period from roughly 350 to 200 BC. The foundation of Structure 26-sub-2 was constructed during the Cunil phase of the early Middle Preclassic period based on a single sample (39E33) from Feature 20, the burnt offering that dates to between 1124 and 1013 BC. However, evidence from the surface of Structure 26-sub-2 suggest that this mound was occupied and modified—though perhaps not continuously—over many centuries prior to the construction of Structure 26-sub-1. A sample directly targeting Alvin’s Floor (39D17), the surviving fragment of a packed clay floor that likely served as the last surviving surface of Structure 26-sub-2, is obviously erroneous, and Mixer believes the sample was contaminated with modern carbon. However, a sample collected at the same elevation of Alvin Floor (19D13) but located a few centimeters west of its well-preserved edge points to evidence of occupation somewhere between 541 and 402 BC, the transition between the Middle and Late Preclassic periods. Overall, the mound stratigraphy in Unit D is complex. Here, a limestone layer (AU33), Alvin’s Floor (AU34), clay fill on top these deposits, and the underlying Cunil-age mound converge. It is likely that these deposits are stratigraphically layered elsewhere in the mound, but here, they were cut to place the stone riser and Str. 26-6<sup>th</sup>s stairstep, Gallinola. Indeed, analysis of the stratigraphy, ceramic diagnostics, and radiocarbon samples point to different phases of construction in the Middle Preclassic period. How these dates address issues within the ceramic chronology will be addressed below, but at this point, it is obvious that additional samples are required to more precisely date ceramic complexes (Hermitage, Floral Park, Mt. Hope, and Barton Creek). Bayesian modeling is also required to model architectural and ceramic complex boundaries.

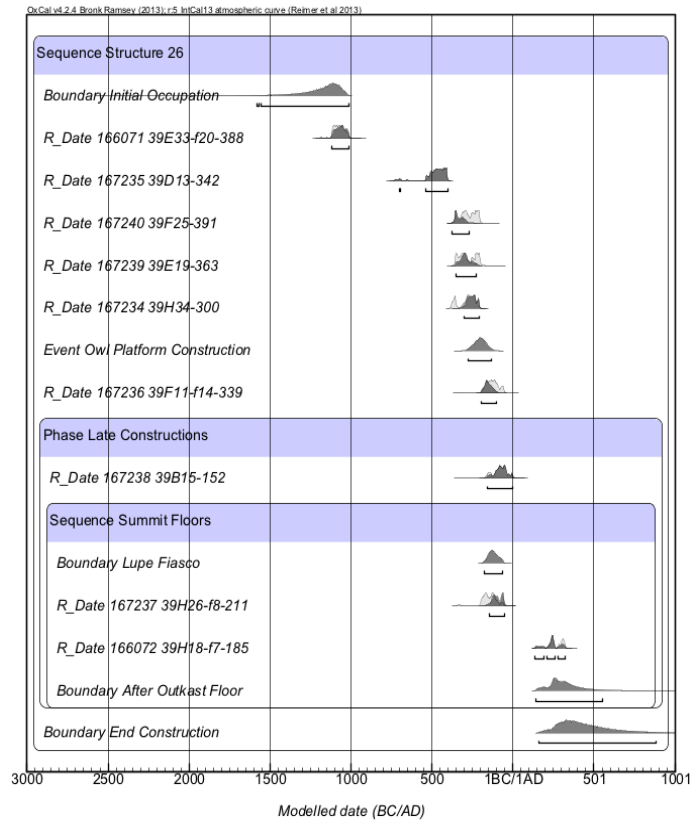

Figure 3.3. Simple Bayesian model for Structure 26 radiocarbon dates.

**Sequence Structure 26**  
**Boundary Initial Occupation**  
 166071 39E33-f20-388  
 167235 39D13-342  
 167240 39F25-391  
 167239 39E19-363  
 167234 39H34-300  
**Event Owl Platform Construction**  
 167236 39-F11-f14-339  
**Phase Late Constructions**  
 167238 39B15-152  
**Sequence Summit Floors**  
**Boundary Lupe Fiasco**  
 167239 39H26-f8-211  
 166072 39H18-f7-185  
**Boundary After Outkast Floor**  
**Boundary End Construction**

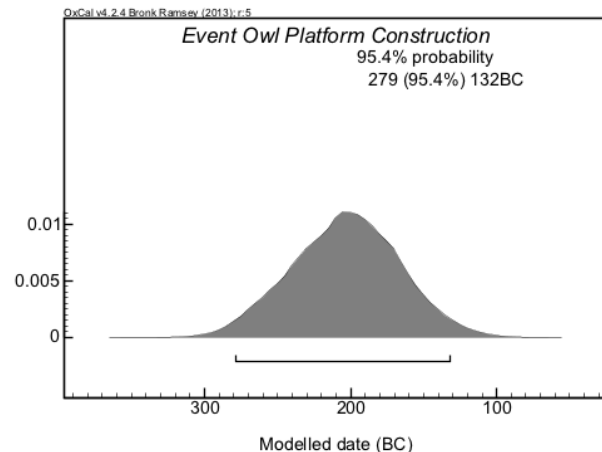

Figure 3.5. Initial Owl Platform construction event as modeled by Bayesian analysis

Figure 3.4. Model of Structure 26 stratigraphic sequence. Presented from oldest to youngest.

#### Bayesian Modeling Results

In recent years archaeologists have been able to produce more precise chronologies using Bayesian analyses that prioritize stratigraphy as a way to model radiocarbon dates. In principle, by combining multiple dates into a stratigraphic model, the confidence intervals can be constrained under the assumption that dates follow a chronological order that reflects the stratigraphy of the deposits from which they originate. In Bayesian terms, the stratigraphy is prior information (*a priori*) that can be combined with a likelihood function and the available data, in this case the calibrated radiocarbon dates, to produce a posterior probability distribution.

For this study, we created a simple Bayesian model that places our dates in stratigraphic sequence in OxCal 4.2 (Bronk Ramsey 2009). Using the *Sequence* function (Bronk Ramsey 2008), dates were ordered according to the stratigraphic model defined in the Harris Matrix presented in Figure 3.A.2 (Figures 3.3 and 3.4). Additionally, the *Date* function was used to estimate the initial construction of the Owl Platform, known to have taken place when the first plaster floor (Javier Floor) was constructed over clay fill (AU25) that capped and buried the earlier structure, Str. 26-Sub 1 called Brown Jay Platform (Figure 3.5). This event was prior to the placement of a cache of water jars (39F11) into Javier Floor. The entire model can be viewed in Figures 3.3 and 3.4.

The dates of certain construction events can be narrowed through Bayesian modelling. Based on the sample from 39F25, the construction of Structure 26-sub-1-2<sup>nd</sup> (Lower Brown Jay Platform) can be dated to between 377 and 271 B.C., an ~100 year error range. Prior to modelling, the calibrated date on this sample had a ~150 error range. Similarly, the construction of Structure 26-sub-1-1<sup>st</sup> (Upper Brown Jay Platform) ranges between 354 and 225 B.C. based on the sample from 39E19; while the deposition of clay fill over Structure 26-sub-1-1<sup>st</sup> can be dated to between 304 and 207 B.C. based on sample 39H34.

A series of samples from features on Structure 26's summit date the construction sequence of nine plaster floors. A date from Feature 14 (39F11), a pit filled with burned and broken water jars, indicates that Javier Floor (the earliest floor) was in use at a date between 197 and 105 B.C. Subsequently, carbon from a burned post in Lupe Fiasco Floor (Feature 8, 39H26), the fourth floor, indicates that it was in use at a date between 146 and 50 B.C. Finally, a piece of carbon from a posthole in Outkast Floor (39H18 Feature 7), the last plaster floor on the summit of Structure 26, indicates that it was in use on a date between A.D. 138 and 324. The single sample from Brees Step (39B15), part of the Structure 26-3<sup>rd</sup> staircase, could not be directly placed in sequence with the samples from the summit floors, but returns a modelled date of 156 B.C. to A.D 2 based on the knowledge that this staircase post-dated the use of Javier Floor.

This model provides us with the opportunity to come to some interesting conclusions regarding the timing and pace of different construction events. First of all, using the *Date* function, we can estimate when Owl Platform was initially constructed by assuming it took place between the placement of the orange fill (AU25) above Str. 26-Sub-1 and Feature 14, the water jar cache into the first floor (Javier). This function estimates with 95.4% confidence that Owl Platform was constructed on a date between 279 and 133 B.C. (see Figure 3.5 for a probability distribution of this date). Additionally, the *Difference* function can be used to estimate how the pace of floor construction changed over time. The *Difference* function indicates that 9 to 133 years (95.4% confidence) passed between the construction of Structure 26-sub-1 (39F25) and when it was covered by the clay cap found under Javier Floor (39H34). Later, six floors (Javier, Armando, Luciano, Rene, Santo and Lupe Fiasco) were built between the placement of Features 14 and 8. The *Difference* function provides evidence to suggest that the floors were constructed over a 5 to 110 year period (95.4% confidence), or on average, every 1 to 22 years. In contrast, three floors (Ice Cube, Missy Elliot, Outkast) were built between the placement of Features 8 and 7, with Feature 7, a posthole in Outkast Floor as the final event. The *Difference* function indicates that these floors were constructed over a much longer period of time, sometime between: 215 to 441 years (95% confidence), or on average, one floor every 72 to 147 years. This suggests that the later floors were constructed at a much slower pace and utilized for long periods of time. The ultimate goal of the Bayesian model is to narrow the date ranges of Preclassic ceramic phases using radiocarbon dates from other contexts at the site.

### **Seriation of Late and Terminal Preclassic Pottery: An On-going Effort**

In this section, LeCount discusses her on-going Preclassic pottery seriation that began in 2014 (LeCount 2015), and she attempts to correlate diagnostics to absolute dates discussed above. Although James Gifford's (1976) ceramic classification system and chronology developed at the site of Barton Ramie is still considered the Bible for many ceramicists in the region, it is becoming widely understood that we increasingly need more precise temporal frameworks and innovative classification schemes to answer particular chronological issues. One of these issues is the Late Preclassic to Early Classic transition. The timing of Actuncan's rise to power falls squarely into this transition, and therefore we have an opportunity to provide additional data to help resolve one of the most problematic parts of Gifford's ceramic sequence.

As described in the introduction, the biggest issue with Late Preclassic pottery is chronological, particularly at the late end of the period associated with the Mount Hope and Floral Park complexes and the Protoclassic question. If we follow Gifford's chronology, as well as Culbert's (1993), we assume there was an unmixed Mount Hope complex pre-dating the introduction of Floral Park diagnostics in Belize Valley sites. However, most archaeologists don't separate the two because stratigraphy can be

problematic and diagnostic types are difficult to recognize. During the Terminal Preclassic period, which we associate here with both the Mount Hope and Floral Park complexes, potters developed new surface treatments (glossy polishes), slip colors (brown and orange), and decorations including waxy-line resist, positive painting and, in the latest phase, the first polychrome types. Unfortunately, these innovations also resulted in hybrid attributes, presumably because the dispersed and relatively small-scale nature of ceramic production meant that potters rendered these techniques imperfectly or had their own ideas about how pottery should look. Terminal Preclassic pottery can have semi-waxy or almost-glossy surfaces and slip colors range from black to brownish-black to brownish-orange to orangey-reds to true reds and oranges. Mottling appears to be a stylistic goal rather than a firing problem. The difference between glossy and waxy surfaces is based on feel, while color is a continuous spectrum. The question is where you draw the line in each case, and researchers see and feel them differently. The range of surface treatments and variation in slip colors make categorization very subjective. Finally, some types have very long lives, especially Sierra Red, a waxy red type that spans the Late Preclassic to Early Classic transition. Apparently, waxy red pottery was “doxa” to the Preclassic Maya, in other words a highly valued tradition that resulted in biased choices of color and shine within the *chaîne opératoire* of ancient manufacture.

Rather than bemoan the fact that Preclassic Maya ceramic styles do not perform as index fossils the way Gifford intended, we can use them to our advantage in frequency seriation, a technique that effectively deals with changing styles over time. At Actuncan, the stratigraphy is fairly fine-grain within some structures, such as Structure 26 that has 9 summit floors and 6 staircases and Structure 41 that has at least 3 summit building stages and 6 plaza floors below it. Therefore, our collections should be able to generate a fine-grain seriation of diagnostics across the Late Preclassic to Early Classic periods. However, in all structures there are gaps in stratigraphy, and deposits from multiple structures are required to span them.

### *Methods*

LeCount prefers to seriate pottery collections from stratified deposits, a technique called interdigitated percentage stratigraphy. “Percentage stratigraphy plots the frequency of types, but the order of collections is based on their superposition” (Lyman et al. 1998:239). The term interdigitation denotes the use of data from several excavation units. When ordering interdigitated proveniences on the chart, the researchers cannot willfully violate the law of superposition by placing collections out of stratigraphic order to make the battleship curves behave properly. For the more precise seriation, fine-grain rather than coarse grain deposits are best.

Most Mayanists prefer to work with pottery types, but LeCount chooses to seriate attributes. Types, defined by the co-occurrence of attributes, are certainly easier to talk about. They condense variation by overlooking minor inconsistencies within types and accentuating differences between them. Some, like Mount Maloney Black, are highly consistent in slip color, surface treatment, and paste composition, and because their lip forms change through time, are reliable behavioral markers of time, production techniques, and function. However, other types are not reliable, such as many of Gifford’s striated types and Terminal Preclassic red wares which subsume too much variation in rim forms and pastes; therefore, focusing on types can result in confusion and loss of important variation they display.

To seriate the Late Preclassic to Early Classic diagnostics, LeCount decided that the first step should be charting the frequencies of wares---combinations of surface treatment, slip color, and paint technique on sherds, not just rims. These attributes make up the basis of Gifford’s types, but without the additional details of formal or stylistic modes that appear sporadically in collections dominated by body

sherds. In the field lab, she coded the counts of each ware, as well as other variables into a Microsoft Access database for hundreds of Actuncan proveniences over the course of two field seasons. But for the seriation she settled on 36 lots associated with deeply stratified floor and fill deposits in three elite domestic structures (Structures 41, 40, 29), two commoner households (Group 1 and 5), and two civic structures within the E-Group (Structures 23 and 26). The E-Group lots were included because Structures 23 and 26 contained many construction episodes dating to the target period. LeCount did most of the coding for this seriation project given the subjective nature of the attributes, although Simova's data was used for early collections in Structure 26. To seriate diagnostics, LeCount used Tim Hunt and Carl Lipo's Frequency Seriation Tool 3.0 software (Lipo 2000; Lipo et al. 1997). It does the tedious work of calculating frequencies of styles by row and creating a Ford Diagram, but requires manual placement of proveniences into a stratigraphically correct sequence in the database to produce an array of battleship curves.

It must be recognized that the collections did not all come from closed finds, rather some came from floors and fills. Although care was taken to seriate collections from finely layered construction sequences, floor and fill deposits can be mixed thus increasing the frequency of early diagnostics in later deposits. Therefore, innovations such as new slip colors, surface treatments, and decorative technique—such as the onset of polychrome painting—can be traced by their terminus post quem “starting points”. Remember, the order of the collections obeyed the law of superpositioning; therefore, the appearance of early styles in later collections is an indication of mixed deposits.

After the first run of the software, many of the proveniences with small sample sizes did not seriate. They contained only a few dominant surface treatments like unslipped plainware, waxy reds and little else. So lots that came from the same analytical unit such as a continuous floor, fill, or feature were lumped together to increase sample sizes. Also characterizing subtle differences in color was problematic. For both waxy and polished wares, black and dark brown slip colors were lumped together since they often graded together on the same sherd. For waxy wares, red and orange slips were lumped together. Although LeCount believes the Maya understood these colors as different, their choices about how to render them are challenging to understand if working with sherd collections. Obviously, whole, well-preserved vessels are best for color classification. For the final seriation, some wares such as unslipped plainware and matte black that did not change in frequency over time were removed because they did not help visualize shifts in diagnostics. Therefore, the seriation is based on diagnostic attributes, and it does not generate a ceramic complex although that can be extrapolated using the original raw data. To seriate correctly, collections had to have around 50 diagnostic sherds so that LeCount felt confident about achieving the expected range of variation within the ware universe. In the end, the Ford Diagram contained 15 proveniences and 13 diagnostic styles (Figure 3.6).

First, LeCount describes trends in the data and then compares them to data published in other ceramic reports from nearby sites. Comparisons at this level of analysis can only be accomplished with frequency data. Second, she will describe the three Late Preclassic complexes as understood through the seriation data. These data are not the same as those from single occupation deposits, so frequencies of groups and types for Actuncan's complexes have yet to be determined. Here we use Xunantunich Archaeological Project (XAP) complex names, given the close connections between the two sites. However, LeCount never separated Mount Hope and Floral Park complexes at Xunantunich because the XAP data were not strong enough to do so. Here, Barton Creek, Mount Hope and Floral Park complex names will be retained for the time being, since issues concerning their composition and chronological position are at the heart of the discussion. It is the goal of this analysis for the Terminal Preclassic Complex, Pek'kat, to be subdivided into Pek'kat I and II.

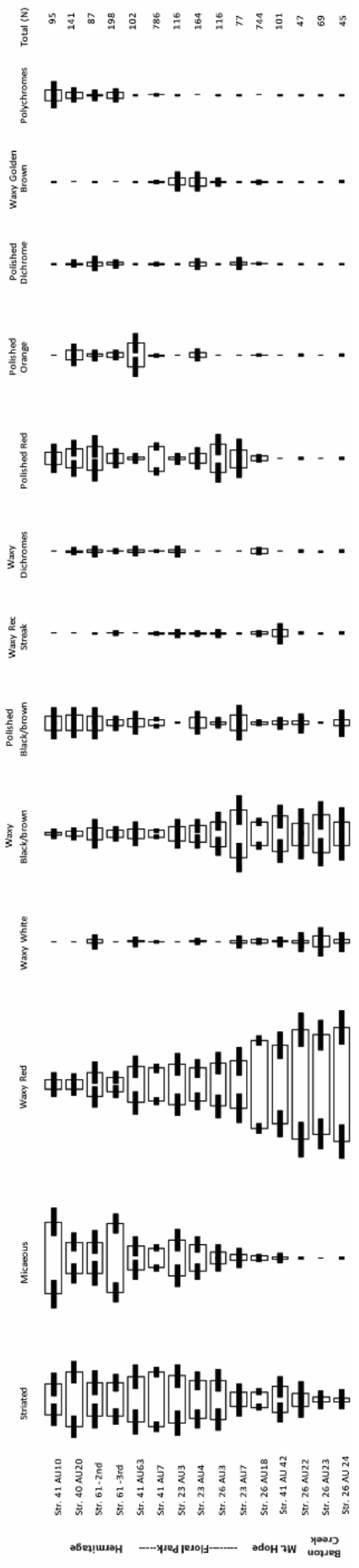

Figure 3.6. Frequency seriation of Preclassic surface treatments from Actuncan

## Results

One of the most visually striking temporal trends in Figure 3.6 is the steady decline in waxy red wares through time. Starting with the earliest collections associated with the Barton Creek Complex red waxy wares dominate the assemblage at 75 to 65% of diagnostics; however, these frequencies fall to 60 to 50% for the Mount Hope Complex, 30 to 20% for the Floral Park Complex and 15 to 5% for the Hermitage Complex. It is the distinct differences in frequencies that allow for the association of collections with complexes. This trend has been noted by others, but here LeCount wants to add an important caveat. First, although Sierra Ceramic Group dominates the Barton Creek Complex and persists until the Early Classic period, red waxy wares in later collections may contain members of other waxy red ceramic groups. Quacco Creek is a little discussed Mount Hope group that often is indistinguishable from Sierra unless specific secondary features are present. In this seriation, LeCount did not try to separate the two; therefore, Quacco Creek types are included in these totals. However, other later red types may have been unintentionally included in this general red waxy category. For instance San Felipe types, such as San Felipe Brown, sometimes appear more red than brown. Some Aguacate and Minanha Group sherds also may have been unintentionally included given the difficulty of separating waxy and glossy surface treatments and red to orange slip colors. These later, ambiguous looking red wares are generally recognizable based on their finer pastes, better sorted tempers and thinner sidewalls, but some might have been included.

The frequency of waxy red wares in Actuncan's Barton Creek collections is very comparable to that documented by Gifford for his Barton Ramie complex. At Barton Ramie, Sierra Group makes up 68% of slipped diagnostics, while at Actuncan it ranges between 75 and 65%. Callaghan (2016) provides frequencies of Sierra Red in his Late Preclassic Itzamkanak complex at Holmul, where it makes up 66% of diagnostics (Table 4.1). Sagebiel (2014, Table 1) reports that Sierra Red comprises 70% of Late Preclassic collections at La Milpa, Belize. These similarities indicate that the Actuncan seriation provides valid information for the earliest Late Preclassic complex.

There is no comparable data for Actuncan's Mount Hope Complex. Because Gifford (1976:11) understood types as specific to complex, he did not recognize Sierra Red as a Mount Hope type. How he dealt with Sierra types within collections containing Mount Hope diagnostics is unknown. He could have excluded them from his counts discounting them as the result of admixture or included some transitional styles within Quacco Creek. Given his assumptions about types, it is understandable that our high red waxy ware frequency in the Mount Hope Complex does not compare favorably with his. The only red waxy group he documents is Quacco Creek, which makes up 11% of Mount Hope diagnostics (Gifford 1976, Figures 10 and 11). Callaghan (2016) provides frequencies of Sierra Red in his Terminal Preclassic II Wayab Subcomplex at Holmul, but does not distinguish an intermediate phase analogous to Mount Hope. So no comparison is possible there. Forsyth (1989, Appendix 1) also does not recognize an analogous Mount Hope complex within his Cascabel Late Preclassic complex, which is understandable since his Late Preclassic complex appears very undifferentiated. He includes Zapatista Trickled Dichrome within it, which suggests to LeCount that it contains some later innovations she associated with Mount Hope. Further, Sierra Group makes up 58% of his Cascabel complex, a number that appears to be more indicative of Actuncan's Mount Hope complex.

Actuncan's Floral Park collections cannot be compared to Protoclassic ones either, given the way the Protoclassic is defined as a subset of diagnostic forms and styles. Gifford lists no waxy red wares in Barton Ramie's Floral Park Complex. Callaghan (2016:Table 5.1) reports that Sierra Red makes up 8% of his Terminal Preclassic II Wayab Subcomplex at Holmul. But because the Wayab is a subset of his

Itzamkanak complex, it is difficult to translate his data to ours. Forsyth's (1989, Appendix 1) Protoclassic Paixbancito Complex is dominated by Iberia Orange, and contains only two Ixcario sherds. He does not list any earlier waxy red wares, preferring to cleave closely to the definition of the Protoclassic as a subassemblage.

A second trend visible in Figure 3.6 is the diversification of slip colors, surface treatments and decorative styles through time. In the earliest collections, diagnostics consist of a few bold styles predominately waxy red, white and black slipped sherds. Striated wares are not as abundant when compared to those in Gifford's Barton Ramie complex, a trend LeCount identified in Classic period collections as well. The earliest decorative embellishment to the bold, but simple Barton Creek styles is the addition of a streaky surface treatment on a waxy red slip, called Society Hall Type. Later, waxy dichromes, particularly pseudo-Usulután Types, are evident in the form of wavy trickles produced through resist or painted techniques, as well as a few waxy golden brown surfaces indicative of San Antonio Types. Gifford recognized these types as part of his Mount Hope Complex. Not long thereafter, polished orange and red slips and dichrome painting appear including Aguacate Orange and Gavilan Black-on-orange, which are indicative of Floral Park types. The appearance of these diagnostics on Santo Floor could be the result of a number of factors including mixing or problematic categorization. What is interesting is the fact that polychrome painting does not appear until very late in the sequence. The gap between the appearance of typical Floral Park diagnostics and the introduction of Ixcario is substantial.

Based solely on the frequencies of waxy red, white and black slipped sherds, there is little difference between complexes except that the frequencies of waxy reds decline as new slip colors and surface treatments are introduced. From LeCount's perspective, Actuncan's Mount Hope complex is essentially a Barton Creek assemblage with the introduction of a few new styles including streaky waxy red (Society Hall Type), dichromes (pseudo-Usulután styles and Escobal Group), and golden brown (San Antonio Golden-Brown). Society Hall and San Antonio Golden-Brown are the most reliable, easily recognizable and frequent diagnostics. The Floral Park Complex is more distinctive, although in small assemblages it is difficult to identify important diagnostics because the amount of waxy reds and blacks still make up a relatively large component of the assemblage. That said, the Floral Park Complex is well represented at Actuncan, and much of the site's architecture was built and routinely renovated using fill containing pottery indicative of this complex. Closed finds are common, which are the best for characterizing the complex even though they often contain few vessels or sherds. As LeCount (2015) discussed and illustrated in a previous report, Aguacate Orange (Aguacate, Matte-finished, and Privación Varieties), Guacamallo Red-on-orange, and Gavilan Black-on-orange Types are the best diagnostics for the phase. Mammiform feet occur, but they are often fragmented making their shapes difficult to reconstruct. Slips on Aguacate Group sherds are thinner and polishing is duller than what is normally called Peten Gloss Ware. Slip colors range from orangey-brown, orange-red and orange, although true orange is not as common as Gifford's type name implies. In fact, it is difficult to call almost any Aguacate slips "orange", except for those on Guacamallo and Aguila Types, which are very rare at Actuncan. The few Ixcario Types we have appear to be more similar to Tikan Variety than Ixcario Variety. LeCount agrees with Gifford (1976:144) when he equates Tikan Variety with Aguacate Orange Type with the addition of black and red decoration. Floral Park types can have a distinctive orange-pink paste that Gifford claimed to be the hallmark of Holmul Ware, and some have bright orange and relatively fine pastes similar to Mars Orange Ware. But most are orange-brown in color and display medium texture. These differences suggest a wide-variety of production locales and paste recipes.

Overall, polished sherds are problematic throughout the sequence. A few polished red and orange sherds are present in earlier contexts than expected, especially Luciano Floor. It is difficult to determine

how these sherds came to be included. They could be harbingers of cultural innovations or unwanted infiltrators from the floor above. Polished black sherds seem to exist throughout time, and therefore represent many different types. Additional difficulties exist in distinguishing black surface treatments including waxy, polished, smudged, fire-clouded, reduced or hybrid techniques, and /or differential surface treatment on vessel bodies. These polished sherds need not represent glossy wares. LeCount found few sherds that appear to represent true Peten Gloss, and they were found in later assemblages. In general, a polished surface treatment in and of itself is not diagnostic to any time period.

#### *Absolute Dating of Ceramics*

Absolute dates for these complexes remain problematic. Although we are fairly confident in dating the diversification of the Barton Creek complex to around BC 200, we do not have a firm boundary for its beginning. The Middle Preclassic Jenny Creek complex is not well represented at Actuncan, and this fact makes placing a boundary between Jenny Creek and Barton Creek difficult. Currently, we only find Jenny Creek in mixed contexts. Radiocarbon dates for the Barton Creek complex don't extend back in time beyond 350 BC, which is a commonly cited date for the transition between Middle and Late Preclassic complexes (Inomata et al. 2017). Based on radiocarbon dates within stratigraphic contexts at Actuncan, the Mount Hope Complex clearly post-dates 200 BC. However, its upper and lower boundaries cannot be determined with any precision at this time. If we accept Brady et al.'s radiocarbon dates for their Protoclassic Stage I, we could suggest an upper boundary between 100 and 50 B.C. This bracketing means that the Mount Hope diagnostics were produced during a short 100 to 150 year-long time span before the introduction of additional diagnostics associated with Floral Park.

The onset of the Protoclassic Stage or Subcomplex is widely disputed. Although Brady and colleagues divide the sequence into two stages---Protoclassic Stage 1 dated to 75±25 BC to AD 150 and Protoclassic Stage 2 dated to AD 150 to 400±20---up until recently, many ceramicists placed the boundary between Late Preclassic and Protoclassic later in time, basically ignoring the Protoclassic Stage 1 possibly because it was not present or possibly because it was difficult to define. Callaghan (2008:349) places the introduction of Protoclassic types, such as Ixcanrio Polychrome, between A.D. 120 and 230 at Holmul. Kathryn Reese-Taylor and colleagues (2002) place it between A.D. 159 and 238 or ending as late as 300 (Walker et al. 2006:718) based on hieroglyphic inscriptions and introduction of Ixcanrio Polychrome.

However, new data are beginning to emerge. Inomata and colleagues (2017) recognize the Protoclassic 1 and 2 phases, placing Protoclassic Stage 1 between 75 BC and AD 175 and Proclassic Stage 2 between AD 175 and 300 at Ceibal. They recognize Stage 1 as composed of pseudo-Usulután types with wavy lines and vessels with tetrapod feet, while Stage 2 is associated with the introduction of Ixcanrio polychrome and bulbous mammiform feet. Deborah Walker's (2017) new dates from Cerros also place the Terminal Preclassic beginning around 200 BC, Early Protoclassic beginning at 50 BC and the Late Protoclassic extending from AD 50 to 250. Our Actuncan dates therefore are similar to recent schemes.

Given the importance of Ixcanrio Polychrome in defining phases within the Protoclassic for most working in Petén, we can suggest when it first appears at Actuncan. The radiocarbon date that is best associated with it is Joey's Plaza Fill 1 in Structure 41 dated to AD 134 to 234 (see LeCount 2015:Table 1.1). Like others, our data suggest that Ixcanrio Polychrome is a rather late addition to the Protoclassic Horizon, likely dating to after AD 150.

#### *Discussion*

Like others, we understand changes in Late Preclassic pottery as the introduction of new decorative techniques into an enduring pottery tradition. The French theory of *chaîne opératoire* developed by A.

Leroi-Gourhan suggests that attributes reflect the techniques (tools and gestures) and the manufacturing sequence shared by those who master their production. As such, they are strongly correlated with social groups through learned or transmitted cognitive structures within crafting communities. Therefore, attributes can be used to understand the maintenance of cultural practices and, conversely, the construction of difference based on social boundaries at a level in which specific decisions are made. Classification schemes that view types as index fossils whose presence or absence determines their membership in a ceramic complex suppress cultural dynamism and constrain types into neat little packages. It is our contention that although the introduction of novel Preclassic pottery styles and forms were prompted by new political practices, status hierarchies and economic arrangements, they needn't be lumped into complexes or subcomplexes to be useful in describing and dating specific crafting practices, socio-political dynamics, or trade relations. Given this *chaîne opératoire* perspective documenting changes in Late Preclassic pottery therefore can be based on the frequencies of attributes and the onset of styles rather than subsets or complexes. This perspective allows us to focus on the frequency of a common pottery styles rather than rely on the presence of rare elite or ritual vessels to place collections in time.

### Conclusions

The 2016 lab season, together with Mixer's work with the radiocarbon samples have provided an important data set that we have presented here. Not only do we have a much greater understanding of the construction history of the E-Group, but also a more complete understanding of Actuncan's socio-political development.

Bayesian modeling of recovered radiocarbon dates have further allowed us to see differences in not only the timing, but also the pace of construction and modification events within the three structural phases of the eastern platform. Beginning with the early Middle Preclassic foundation of Structure 26-sub-2, the complex served as an important focal point to the local Cunil phase population. One of the more surprising findings of the analysis has been the identification of a Jenny Creek construction phase on the platform. In the Late Preclassic period, the earthen mound was reconfigured into the larger Brown Jay (26-sub-1) platform with cobble architecture, marking a shift in the organization of the space. It was likely in use between 9 to 133 years. In the Terminal Preclassic period, Owl Platform of Structure 26 marked another shift toward more formal dressed stone and plaster architecture. The data from the first six plaster floors of Structure 26's summit indicate a rapid and consistent pace of construction occurring over a 5 to 110-year period. In contrast, the last three summit plaster floors were built over a much longer period of 215 to 441 years. Nevertheless, despite this greater understanding of the Eastern Platform of the E-Group, more excavations are necessary to determine the pace of construction throughout the E-Group complex and investigate the nature of activity occurring on it over time.

LeCount's ongoing seriation project, which benefits from the fine-grained stratigraphy of Structure 26, further expands our understanding of the social dynamics underling development at Actuncan. In addressing problematic time periods within Gifford's established ceramic chronology, LeCount brings attention to subtle changes over time, reflecting shifts at various levels within the organization of production. Pottery attributes, rather than ceramic types, therefore become important to understanding socio-political changes occurring at the site. In this manner, we can evaluate the Mount Hope diversification in waxy red styles and surface treatments, such as streaky and trickle dichromes and golden browns, in terms of new economic relations, social stratification, and craft practices. While the ceramic chronology of the site will require further excavations, additional ceramic samples, and

radiocarbon dates to resolve ambiguities, these initial analyses supplement our understanding of Late and Terminal Preclassic sociopolitical development at the site.

### References Cited

---

- Bayliss, Alex  
2009 Rolling out Revolution: Using Radiocarbon Dating in Archaeology. *Radiocarbon* 51(1):123-147.
- Brady, James E., Joseph W. Ball, Ronald L. Bishop, Duncan C. Pring, Norman Hammond, and Rupert A. Housley  
1998 The Lowland Maya "Protoclassic": A Reconsideration of Its Nature and Significance. *Ancient Mesoamerica* 9:17-38.
- Bronk Ramsey, Christopher  
2008 Deposition Models for Chronological Records. *Quaternary Science Reviews* 27(1-2):52-60.  
2009 Bayesian Analysis of Radiocarbon Dates. *Radiocarbon* 51(1):337-360.
- Buck, C. E., J. B. Kenworthy, C. D. Litton, and A. F. M. Smith  
1991 Combining Archaeology and Radiocarbon Information: A Bayesian Approach to Calibration. *Antiquity* 65:808-21.
- Callaghan, Michael G.  
2008 *Technologies of Power: Ritual Economy and Ceramic Production in the Terminal Preclassic Period Holmul Region, Guatemala*. Unpublished Ph.D. dissertation, Department of Anthropology, Vanderbilt.
- Callaghan, Michael G., and Nina Neivens de Estrada  
2016 *The Ceramic Sequence of the Holmul Region, Guatemala*. The University of Arizona Press, Tucson.
- Culbert, T. Patrick  
1993 *The Ceramics of Tikal—Vessels from the Burials, Caches and Problematical Deposits*. Tikal Report 25A. University Museum Monograph, 81, University of Pennsylvania Museum of Archaeology and Anthropology
- Culleton, Brendan J., Keith M. Prufer, and Douglas J. Kennett  
2012 A Bayesian AMS <sup>14</sup>C Chronology of the Classic Maya Center of Uxbenká, Belize. *Journal of Archaeological Science* 39(5):1572-1586.
- Donohue, Luke  
2014 Excavations at Structures 26 and 27 in Actuncan's E-Group. In *Actuncan Archaeological Project: Report of the Sixth Season*, edited by Lisa J. LeCount, pp. 131-150. Report submitted to the Institute of Archaeology, Belmopan, Belize.
- Doyle, James A.  
2012 Regroup on "E-Groups": Monumentality and Early Centers in the Middle Preclassic Maya Lowlands. *Latin American Antiquity* 23(4):355-379.
- Estrada-Belli, Francisco  
2011 *The First Maya Civilization: Ritual and Power Before the Classic Period*. Routledge, London; New York.
- Forsyth, Donald W.  
1989 *The Ceramics of El Mirador, Peten, Guatemala*. New World Archaeological Foundation, Brigham Young University.
- Garber, James F., M. Kathryn Brown, Jaimes J. Awe, and Christopher J. Hartman  
2004 Middle Formative Prehistory of the Central Belize Valley: An Examination of Architecture, Material Culture, and Sociopolitical Change at Blackman Eddy. In *The Ancient Maya of the Belize*

- Valley, Half a Century of Archaeological Research*, edited by J. F. Garber, pp. 25-47. University Press of Florida, Gainesville.
- Gifford, James C.  
 1976 *Prehistoric Pottery Analysis and the Ceramics of Barton Ramie in the Belize Valley*. Memoirs of the Peabody Museum of Archaeology and Ethnology, Harvard University 18. Peabody Museum of Archaeology and Ethnology, Harvard University, Cambridge, Mass.
- Heindel, Theresa  
 2016 Initial Excavations at Structure 23 in Actuncan's E-Group. In *Actuncan Archaeological Project: Report of the Eighth Season*, edited by Lisa J. LeCount and David W. Mixter, pp. 40-51. Report submitted to the Institute of Archaeology, Belmopan, Belize.
- Inomata, Takeshi  
 2017 The Isthmian Origins of the E Group and its Adoption in the Maya. In *Lowlands Maya E Groups: Calendars, Astronomy, and Urbanism in the Early Lowlands*, edited by David A. Freidel, Arlen F. Chase, Anne S. Dowd, and Jerry Murdock, pp., University Press of Florida, Gainesville.
- Inomata, Takeshi, Jessica MacLellan, and Melissa Burham  
 2015 The Construction of Public and Domestic Spheres in the Preclassic Maya Lowlands: Public and Domestic Spheres in the Maya Lowlands. *American Anthropologist* 117(3): 519–534.
- Inomata, Takeshi, Daniela Triadan, Kazuo Aoyama, Victor Castillo, and Hitoshi Yonenobu  
 2013 Early Ceremonial Constructions at Ceibal, Guatemala, and the Origins of Lowland Maya Civilization. *Science* 340:467-471.
- Takeshi Inomata, Daniela Triadan, Jessica MacLellan, Melissa Burham, Kazuo Aoyama, Juan Manuel Palomo, Hitoshi Yonenobu, Flory Pinzón, and Hiroo Nasu  
 2017 High-precision radiocarbon dating of political collapse and dynastic origins at the Maya site of Ceibal, Guatemala. *PNAS Early Edition*: 1-6.
- LeCount, Lisa J.  
 2015 Notes on Terminal Preclassic Ceramic Chronology. In *Actuncan Early Classic Maya Project: Report of the Seventh Season*, edited by Lisa J. LeCount, pp. 1-32. Report submitted to the Institute of Archaeology, Belmopan, Belize.
- LeCount, Lisa J., and Jason Yaeger  
 2010 A Brief Description of Xunantunich. In *Classic Maya Provincial Politics: Xunantunich and its Hinterlands*, edited by Lisa J. LeCount and Jason Yaeger, pp. 67-78. University of Arizona Press, Tucson.
- Lipo, Carl P.  
 2001 *Science, Style and the Study of Community Structure: An Example from the Central Mississippi River Valley*. British Archaeological Reports, International Series, no. 918, Oxford.
- Lipo, C., M. Madsen, R. Dunnell and T. Hunt  
 1997 Population Structure, Cultural Transmission, and Frequency Seriation. *Journal of Anthropological Archaeology* 16(4):33.
- Lyman, R. Lee, Steve Wolverton, and Michael J. O'Brien  
 1998 Seriation, Superposition, and Interdigitation: A History of Americanist Graphic Depictions of Culture Change. *American Antiquity* 63(2):239-262.
- McGovern, James O.  
 2004 *Monumental Ceremonial Architecture and Political Autonomy at the Ancient Maya City of Actuncan, Belize*. Unpublished Ph.D. dissertation, Department of Anthropology, University of California, Los Angeles.
- Mixter, David W., and Krystal Craiker

- 2013 Excavations and Sampling in Plazas C and F and Other Investigations in Group 4. In *Actuncan Early Classic Maya Project: Report of the Fifth Season*, edited by Lisa J. LeCount, pp. 119-130. Report submitted to the Institute of Archaeology, Belmopan, Belize.
- Reimer, Paula J., Edouard Bard, Alex Bayliss, J. Warren Beck, Paul G. Blackwell, Christopher Bronk Ramsey, Caitlin E. Buck, Hai Cheng, R. Lawrence Edwards, Michael Friedrich, Pieter M. Grootes, Thomas P. Guilderson, Hafliði Hafliðason, Irka Hajdas, Christine Hatté, Timothy J. Heaton, Dirk L. Hoffman, Alan G. Hogg, Konrad A. Hughen, Felix Kaiser, Bernd Kromer, Stuard W. Manning, Mu Niu, Ron W. Reimer, David A. Richards, E. Marian Scott, John R. Southon, Richard A. Staff, Christian S. M. Turney, and Johannes van der Plicht
- 2013 Intcal13 and Marine13 Radiocarbon Age Calibration Curves 0-50,000 Years Cal Bp. *Radiocarbon* 55(4):1869-1887.
- Reese-Taylor, Kathryn and Debra S. Walker
- 2002 The Passage of the Late Preclassic into the Early Classic. In *Ancient Maya Political Economies*, edited by Marilyn Masson and David A. Freidel. Altamira Press, Walnut Creek, CA.
- Sagebiel, Kerry Lynn
- 2014 The Late and Terminal Classic Ceramic Sequence at La Milpa, Belize: Implications for its Occupation History. *Ancient Mesoamerica* 25:115-137.
- Simova, Borislava S., and David W. Mixter
- 2016 On-going Excavations at Structure 26 in Actuncan’s E-Group. In *Actuncan Archaeological Project: Report of the Eighth Season*, edited by Lisa J. LeCount and David W. Mixter, pp. 9-39. Report submitted to the Institute of Archaeology, Belmopan, Belize.
- Taylor-Reese, Kathryn, and Debra S. Walker
- 2002 The Passage of the Late Preclassic into the Early Classic. In *Ancient Maya Political Economies*, edited by Marilyn A. Masson and David A. Freidel, pp. 87-122. AltaMira Press, Walnut Creek.
- Walker, Deborah
- 2017 The Search for Sierra Red: Discerning Ceramic Diversity at Late Preclassic Yaxnohcah. In the symposium *The Dynamics of the Preclassic in the Heart of the Lowlands*, organized by Kathryn Reese-Taylor, Amando Anaya Hernández and Verónica Vázquez López at the 82<sup>nd</sup> Annual Meeting of the Society for American Archaeology, Vancouver, BC, April 1, 2017.
- Walker, Debra S., Kathryn Reese-Taylor, and Peter Mathews
- 2006 Después de la caída: Una redefinición del Clásico Temprano Maya. En *XIX Simposio de Investigaciones Arqueológicas en Guatemala, 2005*, editado por J.P. Laporte, B. Arroyo y H. Mejía, pp.715-728. Museo Nacional de Arqueología y Etnología, Guatemala (versión digital).

---

Appendix 3.A

---

Table 3.A.1: Analytical Units.

<b>AU</b>	<b>AU Name</b>	<b>Lots</b>	<b>TPQ complex</b>
1	Modern Surface	A1, B1, C1, D1, E1, F1, G1, H1, H10, I1	LC II
2	Collapse	A2, B2, C2, D2, E2, F2, G2, H2, I2, A3, F3, H3, H11, I2.	LC
3	<i>Outkast Floor and Fill</i>	F4, G3, G8, H4, H12, H19, I3	Floral Park
4	<i>Missy Elliot Floor</i>	G4, G9, I4, H5, H13 H14, H21, H22	Floral Park
5	<i>Ice Cube Floor</i>	G10, H6, H15, H23, I5	Floral Park
6	<i>Burial 18</i>	I6, H7, G5	Floral Park

7	<i>Feature 21- Posthole and Feature Fill</i>	F5	Undetermined
8	<i>Feature 5- Posthole</i>	H8	Undetermined
9	<i>Lupe Fiasco Floor and Fill</i>	E3, F6, G12, H9, H27	Floral Park
10	<i>Biggie Plaza Floor</i>	A4	Late Classic I?
11	<i>Tupac Plaza Floor and Fill</i>	A5	Early Classic
12	<i>Structure 26-1st Construction Fill</i>	A6, B3, B4, B5, B6, B7, C3, C4, C5, C6, C7, C8, D3	Floral Park
13	<i>Kanye Plaza Floor</i>	A7	Floral Park?
14	<i>Kanye Plaza Fill</i>	A8	Undetermined
15	<i>McCoy (Second) Staircase</i>	B8, B9, B11, C9, C10, C11, D4, D5	Floral Park
16	<i>Feature 4- Ceramic Cache</i>	B10	Floral Park
17	<i>Dengue Plaza Floor</i>	A9, B12	Mt. Hope?
18	<i>Santo (Jay-Z) Floor and Fill</i>	E4, F7, G15, H28	Mt. Hope
19	<i>Brees (Third) Staircase</i>	B13, B15, B16, B17, C12, C13, C14, C17, D5, D6	Floral Park
20	<i>Nelly Plaza Floor</i>	A10, B14, B19, B21, B24	Floral Park?
21	<i>Rene Floor</i>	G16, H29	Mt. Hope
22	<i>Luciano Floor</i>	F8, G17, H30	MH/BC
23	<i>Armando Floor</i>	E6, F9, G18, H31	Barton Creek
24	<i>Javier Floor</i>	E8, F12, G20, H33	Barton Creek
25	<i>Clay Fill Above Str. 26-sub-1</i>	F13, F14, G21, H34	Barton Creek
26	<i>Robin Wall and Terrace</i>	E14, E15, E16, E17, E18, E19, E20, F15, F17	Barton Creek
27	<i>Lark Wall and Terrace</i>	E25, F20	Barton Creek
28	<i>Warbler Wall and Terrace</i>	E21, E22, E24, E26, F21	Barton Creek
29	<i>Small Cobble Architecture</i>	F18, F19, G22, G23, G24, G25, G26, G27, H30b, H31b, H32b	Barton Creek
30	<i>Gray Clay Cap</i>	G28	Undetermined
31	<i>Sixth Staircase Fill</i>	C28, D14, E12	Barton Creek
32	<i>Upper Brown Jay Platform Fill (Structure 26-sub-1-1st)</i>	G29, G30, G31, F24	BC/Jenny Creek transitional
33	<i>Limestone Fill</i>	D15, E23, E27, E28, E29, E30, E31, F22, F23, F27, G34, G35, G36	Barton Creek
34	<i>Alvin Floor</i>	D16, D17	Barton Creek
35	<i>Small Altar-Feature 22</i>	F16	Undetermined
36	<i>Feature 17-Chert Cache</i>	C35	Unknown
37	<i>Toucan (Fourth) Staircase</i>	B18, C15, C16, C18, C19, D7, D12	
38	<i>Red Hawk (Fifth) Staircase</i>	B25, C20, C21, C22, C24, C25, C26, C30, D8, D9, D10, D11, E9, E10, E13	Barton Creek
39	<i>Small Stone (Sixth) Staircase</i>	C23, C27, C29, D13, E11	Barton Creek
40	<i>Felix Plaza Floor</i>	B26	Undetermined
41	<i>Cunil Clay Fill</i>	A11, A12, B27, C28, C31, C32, C33	Cunil
42	<i>Earthen Mound (Structure 26-sub-2) and Feature 20</i>	E32, E33, F28	Cunil
43	<i>Feature 16</i>	C34	Undetermined
44	<i>Natural Clay</i>	C36	

45	Feature 11- Posthole	G7	
46	Feature 10- Ceramic Cache	H20	Floral Park
47	Feature 7- Posthole	H17, H18	
48	Feature 8- Posthole	H24, H25, H26	ND
49	Feature 6- Posthole	G11	
50	Feature 9- Floor Cut	G13	ND
51	Feature 12- Posthole	G14	
52	Feature 14- Water Jar Feature	F10, F11	Floral Park
53	Feature 13- Stone Feature	G19, H32	Jenny Creek/Cunil
54	Feature 15- posthole	E7	
55	Lower Brown Jay Platform Fill (Structure 26-sub-1-2nd)	F25, F26, G32, G33	Barton Creek
57	Kelvin Floor and Water Feature	B20, B22, B23	Barton Creek
58	Humus and Collapse	G6	

Figure 3.A.1. Harris Matrix for Structure 26 from Simova and Mixter 2016.

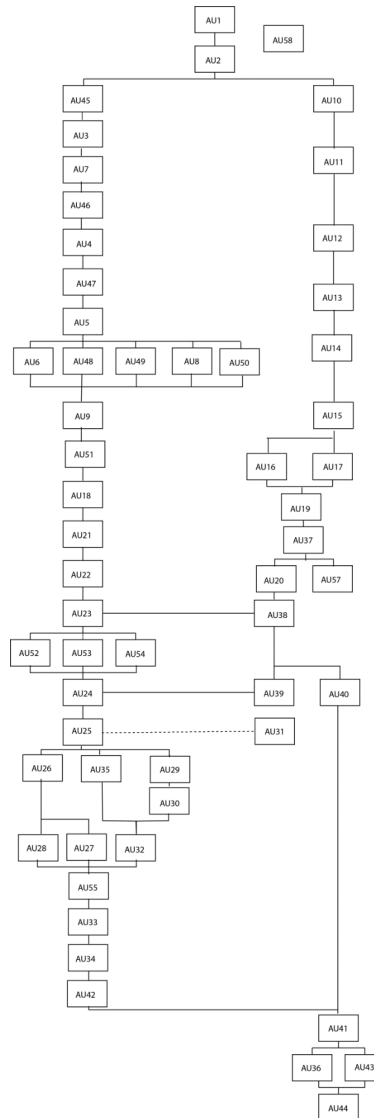
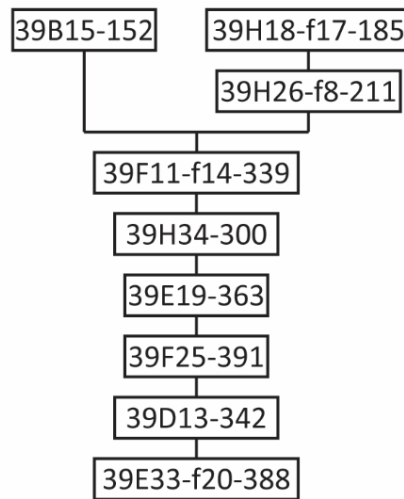

Figure 3.A.2. Simplified C14 Harris Matrix for Structure 26 lots in which radiocarbon dates are available.

### Structure 26 Simplified C14 Harris Matrix



## Chapter 4: Opportunistic Survey and New Actuncan Settlement Data

*Carolyn Freiwald (University of Mississippi)*

---

Opportunistic survey and reconnaissance near Clarissa Falls, Belize in June, 2015 has located mounds in forested areas and agricultural fields northeast of Actuncan on the Galvez property. This brief report describes four locations with mounds and artifact scatters in the hinterlands of Actuncan. It appears that the area between Actuncan, Callar Creek, and Buenavista may have been more densely settled than previously known, but it is unclear when the area was occupied or how extensive the settlement was. These findings provide incentive for more survey in the project area to complement existing settlement work between Actuncan and Buenavista and to better understand how shifting settlement patterns relate to human mobility in the Belize River valley.

### Background and Method

The most significant exploration of the region was conducted by the Xunantunich Archaeological Project (XAP), directed by Richard Leventhal and Wendy Ashmore (Ashmore 1995, Figure 3). XAP members first focused on settlement near the Xunantunich site core during 1992, finding mounds, quarries, and chultunes in a 70 hectare area (Yaeger 1993). The project expanded settlement survey during subsequent field seasons, with one transect (TA/1) extending east across the Mopan River toward the Macal River; a second transect (TA/2) extending north to Actuncan and ending near Callar Creek; TA/3 running parallel to the Macal River and ending near Chaa Creek; and TA/4 as a 1 x 1 square kilometer area between the Xunantunich site core and the Belize-Guatemala border (Ashmore et al. 1994). Mound and site density varied, with more settlement in the TA/1 Mopan River floodplain than the Macal River one, but with differences in the proportion of mounds versus sites identified in each area (Ashmore 1995).

Mounds outside the Actuncan site core are visible in multiple locations including on the Galvez property where the Actuncan Archaeological Project (AAP) headquarters is located. Other large mounds adjacent to, and bisected by, the road to Clarissa Falls also were known to XAP and AAP project members, but formal settlement survey in this area has not been conducted. I conducted limited reconnaissance and opportunistic survey in June 2015 during late afternoon and evening in the vicinity of Clarissa Falls (Figures 4.1 and 4.2).

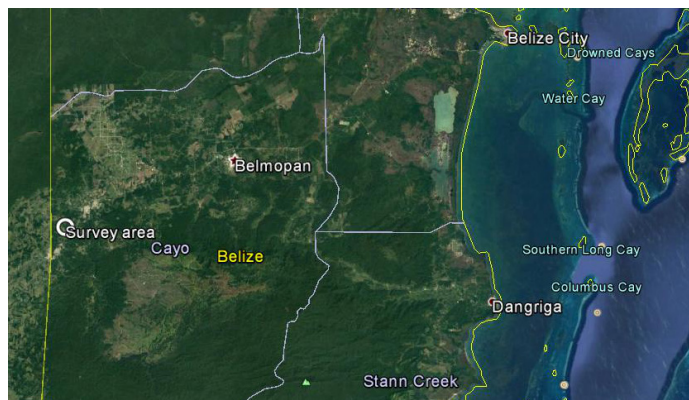

Figure 4.1. Survey area in regional map.

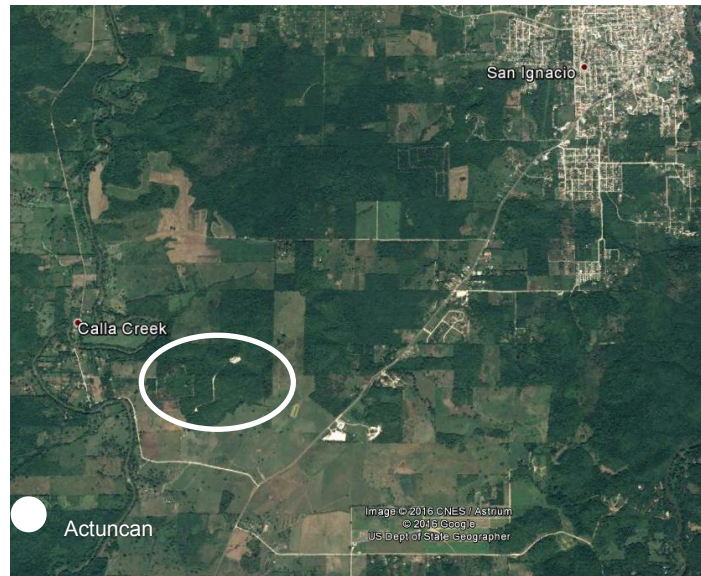

Figure 4.2. Survey area in local map in relation to Actuncan site location.

David Mixter, Tucker Austin, Kelvin Requena, and I also surveyed a hilltop visible from the Actuncan E-Group to test our assumption that there was a mound group. Mound locations were mapped using Google Earth and a handheld GPS unit.

## Results

We identified mounds in four areas that may be part of the same settlement cluster between Actuncan and Buenavista. The first is a group of three mounds situated on a hilltop 2.5 kilometers from Actuncan's site core. David Mixter and I had discussed the potential locations of additional settlement during excavations of the E-Group, especially on hilltops in the viewshed. This particular location was visible from Actuncan and familiar to me from my knowledge of roads and trails near Clarissa Falls, so I decided to conduct some opportunistic survey. A brief reconnaissance identified at least three mounds in a forested area, each of which had old looting episodes in and around the structures. The presumably residential group we call Huechero is labelled in Figure 4.3. No artifacts were visible. Additional structures likely would be identified by formal survey both near this group and along the ridgetop.

Chena Galvez alerted us to the presence of a second set of mounds adjacent to a walking trail on property owned by her family. She provided directions, and I followed the trail and used a hand held GPS unit to mark the location of the eight mounds along the trail (GPS points 53-59 in Figure 4.3). The mounds are in forested property that I did not further explore. However, while returning on a second road, I saw mounds and ceramic scatters in a recently ploughed field (GPS points 33-50 in Figure 4.3). I made the decision to traverse the field and mark the locations as they likely would not be visible when the field was under cultivation again. I also mapped GPS points 60-66 on the mound that is bisected by the road, but did not map in mounds on the Clarissa Falls Resort property.

Other mound groups on the map are located along roads in and around Clarissa Falls, including the approximate location of a residential mound group (marked as such) and the probable location of a set of mounds on private property marked 'yoga center mound group.' These locations are approximately 1.5 kilometers from the site core of Actuncan.

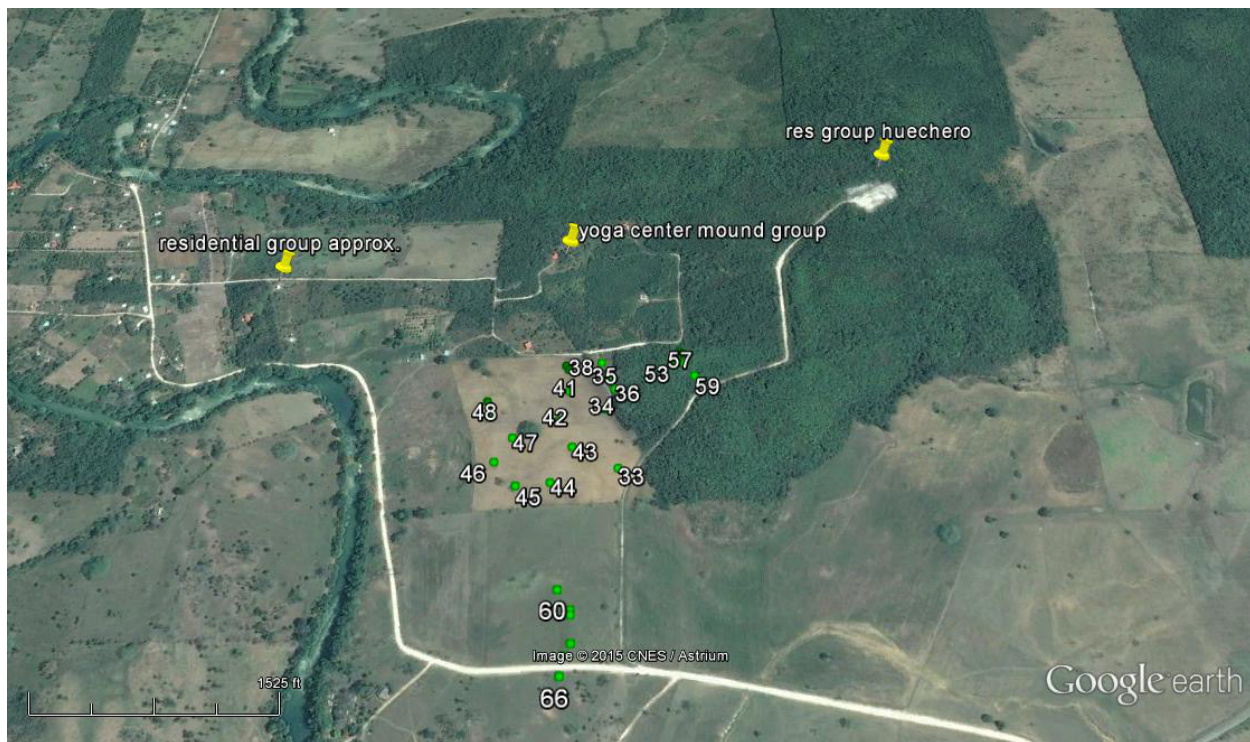

Figure 4.3. GPS points (green) of mounds and tags (yellow) of approximate locations of mound groups.

### Conclusion

There is great potential to find additional settlement in a more systematic settlement survey northeast of Actuncan. I am most interested in determining the time period for these mounds to document whether the settlement clusters were affiliated with Actuncan, Xunantunich or Buenavista. Excavation of residential groups might also shed light on the question of burial locations, whether eastern structures in select mounds groups were used as burial grounds, and when eastern shrines were popular.

### Works Cited

- Ashmore, Wendy  
 1995 Settlement Archaeology at Xunantunich, Belize, Central America. In *Xunantunich Archaeological Project: 1994 Field Season*, edited by Richard Leventhal, pp. 10-24. Belmopan, Belize.
- Ashmore, Wendy, Jason Yeager, Sabrina M. Chase, Jon Vandenbosch, and Samuel V. Connell  
 1994 The Immediate Settlement Context of Xunantunich, Belize. In *Xunantunich Archaeological Project: 1993 Field Season*, edited by Richard Leventhal, pp. 16-28. Belmopan, Belize.
- Yeager, Jason  
 1993 Xunantunich Settlement Survey. In *Xunantunich Archaeological Project: 1992 Field Season*, edited by Richard Leventhal, pp. 110-126. Belmopan, Belize.