

# Sea of Opportunity



**Supply Chain Investment Opportunities  
to Address Marine Plastic Pollution**



# Sea of Opportunity

## Supply Chain Investment Opportunities to Address Marine Plastic Pollution

---

### Recommended Citation

Moss, E., Eidson, A., and Jambeck J., 2017.

Sea of Opportunity: Supply Chain Investment Opportunities to Address Marine Plastic Pollution, Encourage Capital on behalf of Vulcan, Inc., New York, New York.

### Publication Date

February 2017



A Paul G. Allen Company





# Acknowledgements



---

**P**hilanthropist Paul G. Allen funded this report to identify impact investment opportunities for those joining the fight to eliminate plastics pollution as a significant contributor to the rapidly deteriorating health of our ocean. Millions of metric tons of plastic are dumped into our ocean annually, and through this report potential investors will better understand how they can most efficiently and effectively help to disrupt the plastics supply chain and prevent plastics pollution in the first place. Mr. Allen's unique data- and technology-driven approach to some of the world's toughest challenges catalyzes innovation, improves policy, and accelerates change for the better. He believes this report can have the same effect on the future of our ocean.

This report has been produced by Encourage Capital who takes full responsibility for the report's contents and conclusions. While our technical advisors and the many organizations consulted have greatly informed the content of this report, their participation does not necessarily imply endorsement of the report's contents or its conclusions. We are very thankful for their contributions.

#### **Principal Authors**

Ellie Moss, Alex Eidson, Dr. Jenna Jambeck

#### **Contributors**

Ricardo Bayon, Adam Wolfensohn

#### **Reviewers**

Adessium Foundation, Martijn Meijer  
Ellen MacArthur Foundation, Rob Opsomer and Mats Linder  
Global Alliance for Incinerator Alternatives, Christie Keith and Monica Wilson  
Prince of Wales's International Sustainability Unit, Kristian Teleki  
Ocean Conservancy, Andreas Merkl and Joi Danielson  
Ocean Recovery Alliance, Doug Woodring  
Think Beyond Plastics Innovation Accelerator, Daniella Russo  
University of Georgia, Jason Locklin, PhD  
Upstream Policy Institute, Matt Prindiville  
Leah Karrer

## Acknowledgments

Agilyx, Ross Patten and Chris Faulkner, PhD

Association of Plastic Recyclers, John Standish

Closed Loop Partners, Ron Gonen and Rob Kaplan

Colorado State University, Eugene Chen, PhD

Danimer Scientific, Phil van Trump and Jad Dowdy

DSM Environmental Services, Inc., Ted Siegler  
and Natalie Starr

Ecovative, Eben Bayer

ENA Biotech, Inc., Tim Dunn

Fifth Season Ventures, Brian Dawson and Ian Deweerdt

Full Cycle Bioplastics, Andrew Falcon

Goldman Sachs, Paul Rhodes

KCI Technologies, Inc., Thomas Sprehe

Mango Materials, Molly Morse

MBA Polymers, Mike Biddle

Natural Resources Defense Council,  
Mark Izeman and Sarah Chasis

NewWorld Capital, Lou Schick

Norton Point, Ryan Schoenike

Plastic Bank, David Katz and Sean MacMillan

Plastics for Change, Andrew Almack

Prospect Bio, Giles Ochs

RES Polyflow, LLC, Jay Schabel and Mike Dungan

Schmidt Marine, Mark Schrope and Michael Shen

Shift Energy, Adrian Tylim

The American Chemistry Council,  
Steve Russell and Keith Christman

The Dow Chemical Company, Jeff Wooster

The Recycling Partnership, Dylan de Thomas

The Story of Stuff Project, Stiv Wilson

Think Beyond Plastic Innovation Accelerator,  
Daniella Russo

TKingsbury Consulting, Tony Kingsbury

Veolia, Forbes McDougall

W2Worth Innovations, LLC, Jill Boughton

XPRIZE Foundation, Dr. Jyotika Vimrani

Zero Impact Plastics, Minnemijn Smit

---

This report is intended solely as an informational resource for those individuals and organizations seeking to support solutions to the problem of ocean plastics. It is not intended to prescribe specific investment approaches, speculate about potential risks or returns, or recommend individual companies for investment. And, as always, investors need to conduct their own extensive due diligence on these suggestions before making any investments. This report does not claim to have completed exhaustive due diligence on any of these approaches.





# Foreword



---

**O**ver the last five years, plastic waste in the ocean has become a more pressing, quantified, and well-publicized problem. Previously considered benign and dilute, increased attention has put ocean plastic on the agenda for many academics, NGOs, governments and companies.

Data now exist that not only establish that this problem requires immediate and significant attention, but also provide insight into various interventions and where to focus intervention efforts. The story of ocean plastics is interwoven with global development challenges such as poverty, sanitation, sustainable cities and communities, responsible production and consumption, women's empowerment and child labor.

Effectively addressing the causes of ocean plastics will directly and significantly contribute to progress on the 2030 Agenda and Sustainable Development Goals as well as other sustainability

and development-related objectives set by countries and municipalities around the world. More importantly, addressing this problem will lead to a better quality of life for millions – if not billions – of people around the world.

While there is continued interest from traditional government and philanthropic sources on issues of plastic pollution, very little investment capital has flowed to directly address this fast-growing and multifaceted problem. And, given the scale of the problem, it is becoming increasingly clear that the problem is not likely to be resolved without significant investment from private capital sources.

The goal of this report is to show how private capital can play a meaningful role in tackling the issues of plastic pollution across the world's ocean. Numerous investment opportunities are highlighted across the risk/return spectrum where investors can gain a return on investment, while also having a meaningful impact on the problem

of ocean plastics. While investment is the primary focus of this report, it also highlights the role that catalytic philanthropy, citizen engagement, and government actions can play, working in concert with investment solutions across the value chain. Together, these efforts can drive significant reductions in plastic waste generation and losses to the ocean environment.

This is a challenge of global proportions, but, if there is good news, it is that the worst effects of ocean plastics can still be avoided with strategic, timely and coordinated actions. **There is still time, and there is ample opportunity, for diverse funders to make a series of well-orchestrated, high-impact investments that will meaningfully shift the trajectory our ocean is currently following.** However, delayed or diminished efforts will allow a doubling of plastic waste inputs into the ocean, with potentially serious consequences for the ocean, marine life, and human health and wellbeing.

As with many other complex challenges, slowing the flow of plastics into the ocean will require concerted, coordinated and collaborative global action from industry, citizens, non-governmental organizations, governments at all levels, philanthropists and investors. It also touches many large, slow-moving, and interconnected sectors of the economy, everything from the petrochemical industry to industrial design to waste management. This report focuses on the role of investors and opportunities for greatest impact and most attractive returns, with recognition of the critical interdependencies with the work of other actors in the system, especially the complementary role of philanthropists.

This framework for investment is offered with optimism for the potential to effectively slow the flow of plastic waste into the ocean, and in doing so, speed the course of sustainable development globally.



# Table of Contents

---

<b>Acknowledgements</b>	<b><u>2</u></b>
<b>Foreword</b>	<b><u>5</u></b>
<b>Executive Summary</b>	<b><u>10</u></b>
<b>Introduction</b>	<b><u>20</u></b>
<b>Impact Investment Opportunities</b>	<b><u>36</u></b>
<b>Opportunities From Source Through Use</b>	<b><u>37</u></b>
Accelerate and Scale Better Materials	<u>40</u>
Promote Innovative Products and Circular Business Models	<u>56</u>
<b>Opportunities With Post-Consumer Plastics</b>	<b><u>66</u></b>
Advance Collection, Tracking, and Sorting Innovations	<u>78</u>
Engage and Support the Informal Waste Sector	<u>88</u>
Enhance Recycling, Repurposing, and Composting	<u>96</u>
Develop Responsible Waste-to-Energy Conversion Solutions	<u>106</u>
Support Integrated Waste Management Solutions	<u>116</u>
<b>Additional Levers</b>	<b><u>124</u></b>
Philanthropy	<u>126</u>
Citizen Engagement	<u>130</u>
Government Actions	<u>134</u>
<b>Additional Research Needed</b>	<b><u>142</u></b>
<b>Conclusion</b>	<b><u>144</u></b>
<b>References</b>	<b><u>146</u></b>

# Executive Summary



---

# The Problem

*Imagine five grocery-size plastic bags filled with plastic waste. In your mind, stack them one on top of the other. Now picture one stack of five bags for every foot of coastline in the world, across North America, South America, Europe, Asia, Africa, Australia and Antarctica. This is what eight million metric tons of plastic waste looks like. And this is how much plastic waste enters our ocean every year. Without intervention, this number is expected to double to 17 million metric tons per year by 2025.[1]*

**Our ocean is in crisis.** Plastics in the ocean are devastating marine life, damaging ecosystems, burdening fishing and shipping industries with costs of millions of dollars a year, reducing tourism revenue, and accumulating in the food chain for human consumption.[2-6] And yet, each year another eight million metric tons or more of additional plastic waste enters the ocean.[1]

**Plastics in the ocean are a mix of macroplastics and microplastics.** Macroplastics include abandoned

or derelict fishing gear, expanded polystyrene foam, single-use wrappers and plastic bottles. Microplastics are less than five millimeters long and are either intentionally produced (e.g., microbeads) or the result of the photodegradation of macroplastics.[3]

**It is estimated that 80 percent of plastic waste in the ocean comes from land-based sources [3]** and about half of that comes from four countries: China, the Philippines, Indonesia and Vietnam. The other half comes largely from other rapidly developing countries in Asia, Africa, and Latin America, and there is also a contribution from high-income countries with large populations and long coastlines.[1]

**Once they have entered the ocean, plastics end up in nearly every component of the marine environment.** Just where a particular piece will end up is determined partly by its characteristics and partly by the movement of the ocean. Some plastics float, such as polyethylene and polypropylene, while denser plastics sink, ending up as deep as the sea floor.[4]

Plastics have been found in the world's most remote waters, on the ocean floor, in sea ice, in sediment, and littering beaches in uninhabited areas.<sup>[7]</sup>

**The items most commonly found on beaches and in harbors are single-use plastic items such as grocery bags, food packaging, bottles, bottle caps, utensils, and straws.**<sup>[8]</sup> This is not surprising considering about 40 percent of plastic produced each year becomes single-use packaging and another 20-25 percent goes to consumer and institutional products.<sup>[9]</sup>

**Most of the plastic in the ocean is not floating on the surface.** The plastic floating in the five gyres, such as what has been termed the "Great Pacific Garbage Patch," is estimated at 475,000 metric tons<sup>1</sup>, <sup>[10, 11]</sup> a mere fraction of the total amount of plastic in the ocean, and dwarfed in comparison to the estimated eight million metric tons entering the ocean every year. This means that removing all of the plastic currently floating in these five gyres (if this were economically and physically feasible, which it currently is not), would only remove approximately three percent of the plastics entering the ocean each year.

**Ocean plastics are devastating marine life.** Ocean plastics are the single biggest debris threat to marine life today – 82 percent of the debris threats to marine life were plastic.<sup>[5]</sup> Nearly 700 species of fish, birds, sea turtles, sea mammals and other marine animals are known to have been killed by ocean plastic, some in large numbers.<sup>[12]</sup> Ocean plastics can also amplify the exposure of marine life to toxic persistent organic pollutants.<sup>[13]</sup> The implications for human health are not yet well understood.<sup>[3]</sup> Lost or discarded fishing gear is known to damage reefs and other marine environments and it also continues "ghost fishing," where it traps or entangles fish, turtles, birds and other animals, resulting in injury or death.<sup>[14, 15]</sup>

**Ocean plastics also exact social and economic costs.** The short-term social and economic costs are being

borne primarily by coastal communities, commercial fishing and commercial shipping. Losses on the order of tens to hundreds of millions of dollars have been reported by communities and businesses. The longer-term economic and social costs of ocean plastics have the potential to be much higher.<sup>[2, 16]</sup>

**The ocean plastics problem does not begin the moment a plastic bag floats out to sea.** Rather, that moment is the culmination of a cascade of choices made by fossil fuel producers, materials engineers and producers, product designers, small, medium and multinational corporations, entrepreneurs, governments at all levels, waste management companies, informal waste sector workers, and individual citizens.

## The Solutions

**It is essential to take a whole-system view to fully understand both the drivers of – and potential solutions to – plastic waste in the ocean.** With this approach, it becomes evident that there is no single solution to this problem. Instead, a portfolio of interventions is required to address the problem across the value chain and to achieve results at different scales and in different time periods (i.e., in the near-, medium- or long-term).

**The plastics value chain covers the full life cycle of plastic – from design and production through end of life.** The plastics value chain begins with the creation of plastics in their many forms. These plastics are then made into products and packaging, which are selected, used and ideally reused, by consumers. Once consumers are done with these plastics, they become plastic waste for collection and management. Plastics may then be recycled, composted or repurposed, end up in a landfill or dump, or serve as feedstock for "Waste-to-Energy" (WTE). Finally, plastic that has escaped collection and enters the environment may still be captured prior to entering the ocean through last-chance capture.

---

<sup>1</sup> This estimate sums the top microplastic data from source <sup>[10]</sup> and the large items from source <sup>[11]</sup>, which equals 475,000 MT, and then divides by 8 MMT to get the 3 percent value.



**Just as the root causes of the ocean plastics problem are found at each stage of the value chain, so too are the potential solutions.** Stopping the flow of plastics into the ocean requires rethinking and reworking how plastics are made, used, reused and disposed of in a way that is economically viable. The system view also highlights the interdependency and, at times, tension, between different stages of the value chain. For example, successfully increasing reuse requires products that are designed to be reused, infrastructure that facilitates their reuse, and consumers willing to reuse them. Similarly, when considering waste management solutions, it is essential to consider the entire waste process from collection through recycling, conversion or disposal as an integrated whole.

**There are four mechanisms for reducing plastic waste entering the ocean:**

1. Decreasing plastic production,
2. Reducing plastic waste generation,
3. Reducing mismanaged plastic waste, and
4. Capturing mismanaged plastic waste before it becomes ocean plastic.

**This report identifies ten intervention strategies to disrupt the trajectory of accelerating plastic pollution in the ocean.** Of these, seven are high-impact investment strategies to deploy throughout the value chain (and with a variety of risk/return profiles). The remaining three strategies are for additional levers such as philanthropy, citizen engagement, and government actions and the role they play in solving this problem. These sectors, however, are not the focus of this report. A brief overview of this work has been included where it is most relevant to driving investment.

## Impact Investments

**1. Accelerate and Scale Better Materials:** Accelerate the development and scale-up of better (bio-benign or more readily recyclable), commercially viable materials for packaging and single-use plastic applications.

- a. Plastics, additives, and adhesives that emphasize bio-based feedstocks, are less toxic, biodegrade more quickly and/or more easily,

Four Mechanisms Across the Plastics Value Chain for Reducing Plastic Waste Entering the Ocean

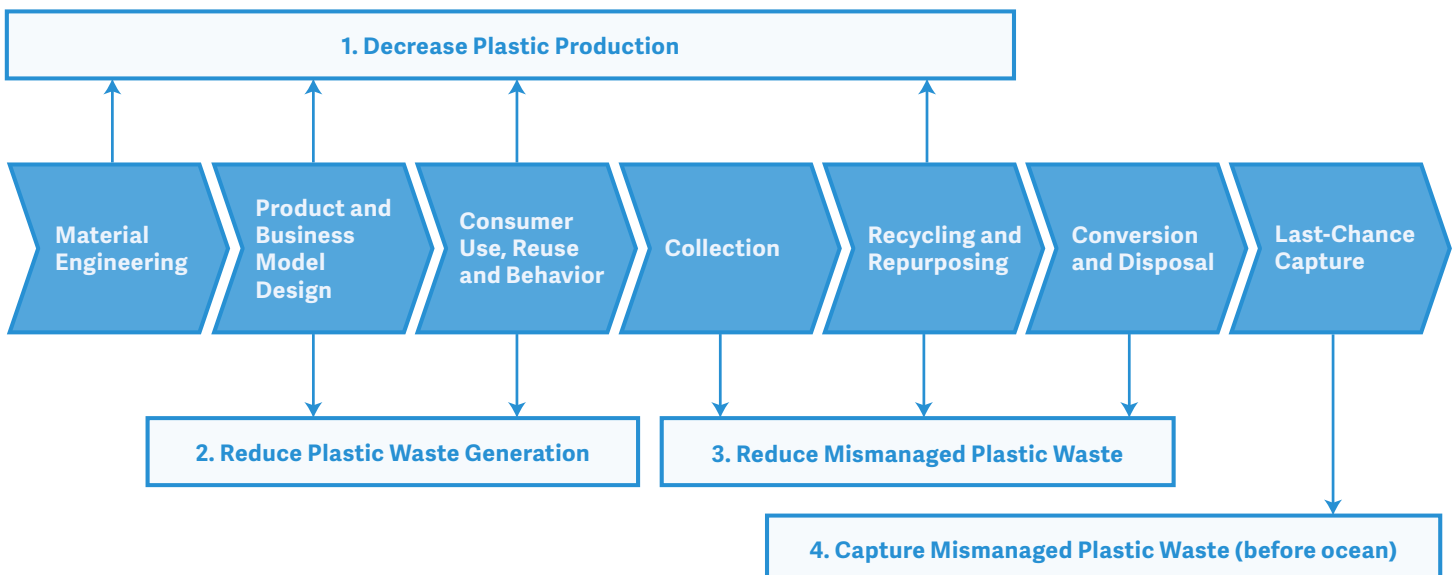

and are economically and fully recyclable  
b. Alternatives to current plastics such as wood, bamboo, algae, mushroom, and others

## 2. Promote Innovative Products and Circular

**Business Models:** Support companies with innovative products and circular economy business models that enable and promote product and packaging reuse, repair and refurbishment, product-as-a-service, recapture and recycling, and reductions in plastic usage.

## 3. Advance Collection, Tracking and Sorting

**Innovations:** Accelerate the adoption at scale of next-generation collection, tracking and sorting technologies that can lead to greater recycling and circularity.

## 4. Engage and Support the Informal Waste Sector:

Provide equipment, opportunities and incentives for the informal waste sector in Southeast Asia, Africa, and Latin America (“waste pickers”) to enhance their collection of low and high-value plastic waste.

## 5. Enhance Recycling, Repurposing and

**Composting:** Support the development and scaling of materials and products that use reclaimed or recycled feedstock, creating pull in the system to better capture waste at each stage of the value chain (both circular loops like bottle-to-bottle recycling as well as waste repurposing).

## 6. Develop Responsible Waste-to-Energy

**Conversion Solutions:** Provide financing for context-driven, environmentally and financially sound advanced Waste-to-Energy (WTE) technologies, such as gasification and pyrolysis, to underwrite scale-up risk from pilot to first commercial plant.\*

*\*Please note: WTE investments require extensive due diligence to assure their economic and environmental viability. There is currently much debate on the role of WTE in waste management and it is out of scope for this report to determine exactly where, how and with what existing or new technologies WTE may make sense, but they are considered a potential solution.*

## 7. Support Integrated Waste Management

**Solutions:** Provide financing for facilities and/or services that are part of integrated waste management solutions in countries with low rates of waste capture and high leakage in areas of Southeast Asia, Africa, and Latin America.

## Additional Levers

**8. Philanthropy:** Use catalytic philanthropy to spur innovation in material design, waste collection, and other sectors.

**9. Citizen Engagement:** Raise public awareness, facilitate ocean-friendly purchasing decisions, and encourage citizens to make modest behavior changes.

**10. Government Actions:** Use policy, international action, and government capital expenditures to accelerate change.

Each of these strategies can play a vital part in reducing the flow of plastic into the ocean and, taken collectively, they represent a comprehensive set of priorities for investment that address the problem of ocean plastic.

## The Role of Investors

**Making this shift to a new, self-sustaining plastic paradigm will require significant investment from businesses, investors, and others.** Unfortunately, to date there has been insufficient investment emphasis placed on any of these solutions, even from development finance institutions. In this context, identifying solutions that are both impactful as well as profitable is of paramount importance for mobilizing capital from a broader group of investors.

**Investors have an opportunity now to make attractive, strategic, high-impact investments to slow the flow of plastic into the ocean and minimize the damage it can do.** There are roles for all types of investors and

a diverse group will be needed to individually and collectively pursue these opportunities.

**Different strategies lend themselves to different types of investment.**

Investors seeking opportunities in multiple asset classes will be able to find investment opportunities that meet a wide range of impact and return criteria. This report is focused on those areas that offer a competitive financial return for a given level of risk, but within that context the opportunities represent a very broad range of asset types and risk/return profiles. For example, investments in material, product and business model design can be structured as either venture capital investments in innovative companies, growth equity financing for more established firms, or debt or equity investments in the infrastructure these firms will need to grow their operations.

**There are a range of different types of funders who may play a role in tackling the ocean plastics problem:** Development Finance Institutions (DFIs), infrastructure investors, impact investors, other private or institutional investors, the private sector, and foundations, philanthropists and other grant funders.

## Opportunities from Plastic Source Through Use

### Accelerate and Scale Better Materials

The ideal portfolio of plastic and alternative options would include cost and performance-competitive materials meeting these criteria, where the materials were bio-based to the extent possible in the near to medium term:

- Backyard/ocean biodegradable plastics for single-use and packaging applications
- High-value recyclable plastics that are easy to identify/sort and are worth collecting (e.g., not too light-weight, single material, no problematic adhesives or additives)
- Biodegradable / water-soluble non-toxic films
- Additives that exclude substances of concern
- Biodegradable adhesives that exclude substances of concern
- Non-plastic, easily biodegradable materials that are suited to their use

Seven Investment Strategies Across the Plastics Value Chain

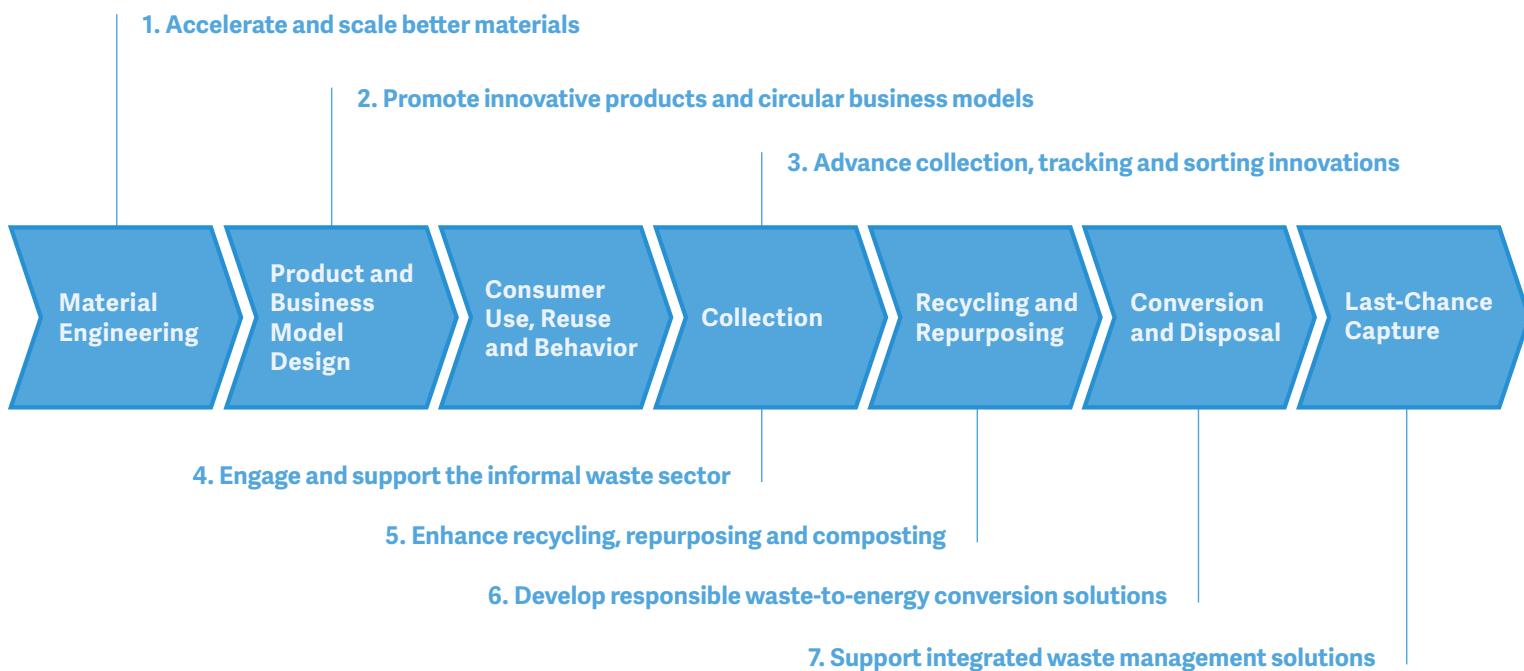

There are promising materials at varying stages of development today that have the potential to be part of the solution. Among the investments considered within the materials innovation section, there are opportunities to deploy venture capital for investments ranging from lab space for the most nascent material science research on the low end to combined debt/equity infrastructure investment for a commercial-scale manufacturing facility on the high end. These materials would be designed to replace the most prevalent and harmful ocean plastics. Individual investments in companies working on the creation of new materials range from \$500,000 to \$50 million for individual investments.

### **Promote Innovative Products and Circular Business Models**

There are six design strategies to inform product and packaging design, with implications for business model design as well:

1. Use less material
2. Design for longer life, repair and refurbishment
3. Enable and promote reuse and refills
4. Improve rates of recapture
5. Design for recyclability
6. Offer product-as-a-service

These innovations present a range of investment opportunities from venture capital investments in innovative companies to growth equity financing for more established firms, to debt or equity investments in the infrastructure these firms will need to grow their operations. This represents a system change, particularly as it relates to delivery systems, reuse, and product-as-a-service models. Additionally, there are also targeted design solutions for fishing gear, which has a distinct set of requirements and constraints. The potential for investment in this area is estimated to range from \$2 million to \$10 million per deal. There is also an opportunity for investors to demand greater transparency on a range of ocean-plastic-related metrics, such as plastic use per unit of revenue, which would enable all investors to better take these impacts into account in their investment strategies.

## **Opportunities with Post-Consumer Plastics**

### **Advance Collection, Tracking and Sorting Innovations**

Collection is the key to diverting plastic waste from the ocean: waste that is collected has a dramatically higher likelihood of being recycled or properly disposed than that which is not. However, collection typically represents a net cost in the waste management process and must be paid for by citizens, businesses and/or government. Finding and scaling ways to reduce the cost of collection is essential to expanding collection services. Innovations in tracking and sorting can further drive down cost and increase the amount of value that can be extracted from the waste stream. There are a range of companies, from start-up to mature, working on innovations that lower cost and improve quality for collection, tracking and sorting of waste streams, which both brings down the cost of collection and increases the potential for material circularity. Investment opportunities in this area range from \$1 million per deal on the low end to \$30 million per deal on the high end.

### **Engage and Support the Informal Waste Sector**

In countries with inadequate waste infrastructure, the “waste pickers” of the informal waste sector collect a significant amount of the total waste collected. Waste picking provides a way for people with very few options to make what is typically a subsistence living but the conditions can be unsanitary and even unsafe. While, historically, attitudes toward waste pickers had been negative, this is now shifting as their work is being recognized as valuable, especially the collection of plastic waste before it enters the ocean. Waste pickers in some locales have even successfully organized into waste picker cooperatives or unions, which offer greater economic opportunity and improve working conditions. Waste worker cooperatives and zero waste groups are seeking funding to expand their work in high-impact countries. They seek loans for small amounts so that they can buy hand- or motorized carts for collection, build small-scale sorting facilities, and educate residents on their programs. The opportunity for investment here ranges from \$500,000 to \$15 million per deal globally over the next three years.

### ***Enhance Recycling, Repurposing and Composting***

Recycling, repurposing and composting are critical to keeping plastic out of the ocean. Simply put: when post-consumer plastic is seen as having sufficient potential value, it will be captured. While the recycling industry has struggled in recent years from challenges to its economics, there are ways to strengthen it and create pull in the system for plastic waste. Specifically, action is needed to innovate recycling processes and technologies, find ways to recycle or repurpose waste into higher-value products, drive greater use of recycled content in packaging, promote recycling for non-plastics as well. It will also be necessary to increase industrial composting capacity to keep pace with the growth in compostable plastics. There are opportunities to support companies that are advancing the use of recycled materials, finding ways to repurpose or recycle a range of different plastic feedstocks for a second life in higher-value products. There are also companies investing in industrial composting capacity. The potential for investment here is estimated to range from \$2 million to \$25 million per deal, covering a range of potential investments from a very basic plastic recycling plant to a state-of-the-art recycling/repurposing facility.

### ***Develop Responsible Waste-to-Energy (WTE) Conversion Solutions***

Incineration, or the combustion of waste, is currently the most common form of WTE, but this category also includes other forms of thermal conversion of waste, such as gasification, pyrolysis, and plasma arc technologies. Although not directly WTE, byproduct gases generated from waste (e.g., through anaerobic digestion and landfill gas), can be used as a source of energy as well. Responsible WTE facilities may contribute to an integrated waste management solution for ocean plastics, though it must be noted that there are divergent views on the economic and environmental viability of WTE technologies, including concerns about their impact on human health. There is evidence that shows that, in some contexts, WTE facilities may be able to use waste to generate energy in a 'double win' for municipalities. However, in other cases, problems with energy generation,

environmental outcomes or financial weakness have led to the failure of some WTE facilities, often with serious consequences for the municipalities that supported them. There are also concerns that WTE discourages waste reduction efforts as waste becomes seen as a needed feedstock. Some observers, however, argue that more advanced technologies hold promise for cleaner, safer and more economically sound WTE, though they will require time and funding to be proven, tested and scaled. Investors interested in WTE solutions should carefully consider all possible benefits, costs, and risks associated with WTE before investing. These facilities can cost anywhere from \$20 million to over \$500 million, depending on their size and technology. In cities that currently lack adequate collection systems to accommodate WTE facilities, the costs of these collection systems must be added to the total and can range from \$5 to \$50 million depending on the size of the municipality.

### ***Support Integrated Waste Management Solutions***

The central challenge of waste management infrastructure development is an economic one: the inherent value of the waste does not cover the cost of collection and disposal. There are opportunities to generate revenue throughout the waste value chain by recycling, composting, and possibly WTE technologies, but their economic viability is dependent on a mix of commodity prices and regulated sources of revenue such as feed-in tariffs and tipping fees, and is subject to supply risk (the quantity and composition of the waste they receive), political risk, contract/counterparty risk and risks from corruption. Nonetheless, creative project developers and investors are finding ways to make viable investments by designing vertically-integrated waste management solutions that draw on diverse sources of investment capital and revenue, mitigate the biggest risks, and are designed to work within the unique local context.

These investments can be structured in a variety of ways, allowing diverse investors to play a part in the ultimate solution. For investors interested in debt investments, cities may issue municipal



debt to pay for: increased collection; waste worker cooperatives in need of loans; and infrastructure for Material Recovery Facilities (MRFs), Plastic Recovery Facilities (PRFs), composting facilities, and WTE facilities. Equity investors can take ownership stakes in any one of a number of WTE companies or waste collection/management companies. Depending on their geographic focus and their existing track records, these investments could display dramatically different risk/return profiles. Individual deals are estimated to range from \$20 million to over \$500 million each.

It must be acknowledged that for some of these investments it is unrealistic to expect “market rate” returns for the given risks. Of the 500 largest cities in developing countries, for example, only 4 percent have sufficient credit to access municipal debt markets. [17] Many of these cities are located in the countries that leak the greatest amount of plastic waste into the ocean, making it imperative to expand their access to financing for urgently needed improvements and infrastructure. Today’s low price of oil and petroleum-based polymers present similar challenges to waste-to-fuel companies and bio-benign plastics producers seeking financing for their first commercial facilities.

In these instances, it will be necessary to layer in concessionary capital from mission-oriented organizations such as foundations, the World Bank, FMO, USAID, and other philanthropic or development-finance institutions together with private investment capital seeking more commercial rates of return. These groups, along with impact investors, may value the environmental benefits and public health outcomes associated with their investment enough to make catalytic but otherwise sub-commercial investments in order to spur innovation and progress.

## Additional Levers

A discussion of the investment opportunities to reduce the flow of plastics into the ocean would be incomplete without recognizing other key levers for change and their ability to amplify the impact of investment.

Philanthropy, citizen engagement, and government policies and actions can complement and strengthen the investment opportunities outlined in this report

**Philanthropy** can be used catalytically in many ways to unlock new investment possibilities. In particular, philanthropy has potential to uncover new solutions through research and development; support higher-risk, high-impact investments; and offer market-altering prizes that may spur new innovations.

### **Citizens globally can and must begin to make choices that can reduce the problem of ocean plastics.**

As individuals across the world make choices today that contribute directly to the ocean plastics problem, they also have significant power to stop the flow of plastic into the ocean. Citizens have two main ways to affect change on ocean plastics: 1. change their purchasing choices, and 2. change their own behavior around plastic use and end-of-life waste management. Before they will do either of these things, however, they first have to understand and care about the problem, emphasizing the importance of raising awareness of this issue globally.

**Governments are critical actors in the fight against ocean plastics.** They can use policy to create the conditions for successful action from material development through the waste management system, engage internationally to support global collective action, and fund efforts that stop the flow of plastic waste into the ocean. In many cases, policies can impact the viability and ultimate success of an investment, either directly or indirectly. Interested investors would be wise to carefully consider the policy landscape relevant to a particular investment opportunity.

This report provides current and potential investors with a solid understanding of the problem, a clear set of actionable solutions, insight into possible investment approaches, and ultimately a compelling framework for coordinated action against ocean plastics.



# Introduction



---

Imagine five grocery-size plastic bags filled with plastic waste. In your mind, stack them one on top of the other. Now picture one stack of five bags for every foot of coastline in the world, across North America, South America, Europe, Asia, Africa, Australia and Antarctica. This is what eight million metric tons of plastic waste looks like. And this is how much plastic waste enters our ocean every year.<sup>[1]</sup>

Population growth, increases in plastics production, and economic development are pushing this number higher year by year, and, without intervention, it is expected to double to 17 million metric tons per year by 2025.<sup>[1]</sup> At that point, Ocean Conservancy has estimated that the cumulative effect will be one ton of plastic for every three tons of finfish in the ocean.<sup>[18]</sup>

Contrary to how many people imagine these plastic accumulations in the ocean, passengers on a cruise ship in the center of the Great Pacific Garbage Patch would not generally be able to see the plastic in the water because most of the floating plastic pieces are too small to be visible from the deck of a large ship.

While much attention has been focused on plastic found floating in the five gyres (such as what is termed the “Great Pacific Garbage Patch”), these contain an estimated 475,000 metric tons<sup>2</sup> <sup>[10, 11]</sup>, a mere fraction of the estimated eight million metric tons entering the ocean every year. This means that removing all of the plastic currently floating in these five gyres (if this were economically and physically feasible, which it currently is not), would only remove approximately three percent of the plastics entering the ocean each year.

Clearly, there must be a shift from thinking of this as a clean-up problem to figuring out how to prevent the plastic from entering the ocean in the first place.

The plastics in the ocean are a mix of macroplastics, or larger pieces of plastic (like packaging, single-use utensils, derelict fishing gear, and expanded polystyrene foam) and microplastics, which are

---

<sup>2</sup> This estimate sums the top microplastic data from source <sup>[10]</sup> and the large items from source <sup>[11]</sup>, which equals 475,000 MT, and then divides by 8 MMT.

# How much plastic is estimated to be in the oceans and where it may be

Figure 1

Plastic Waste Inputs from Land into the Ocean in 2010

Source: [20]

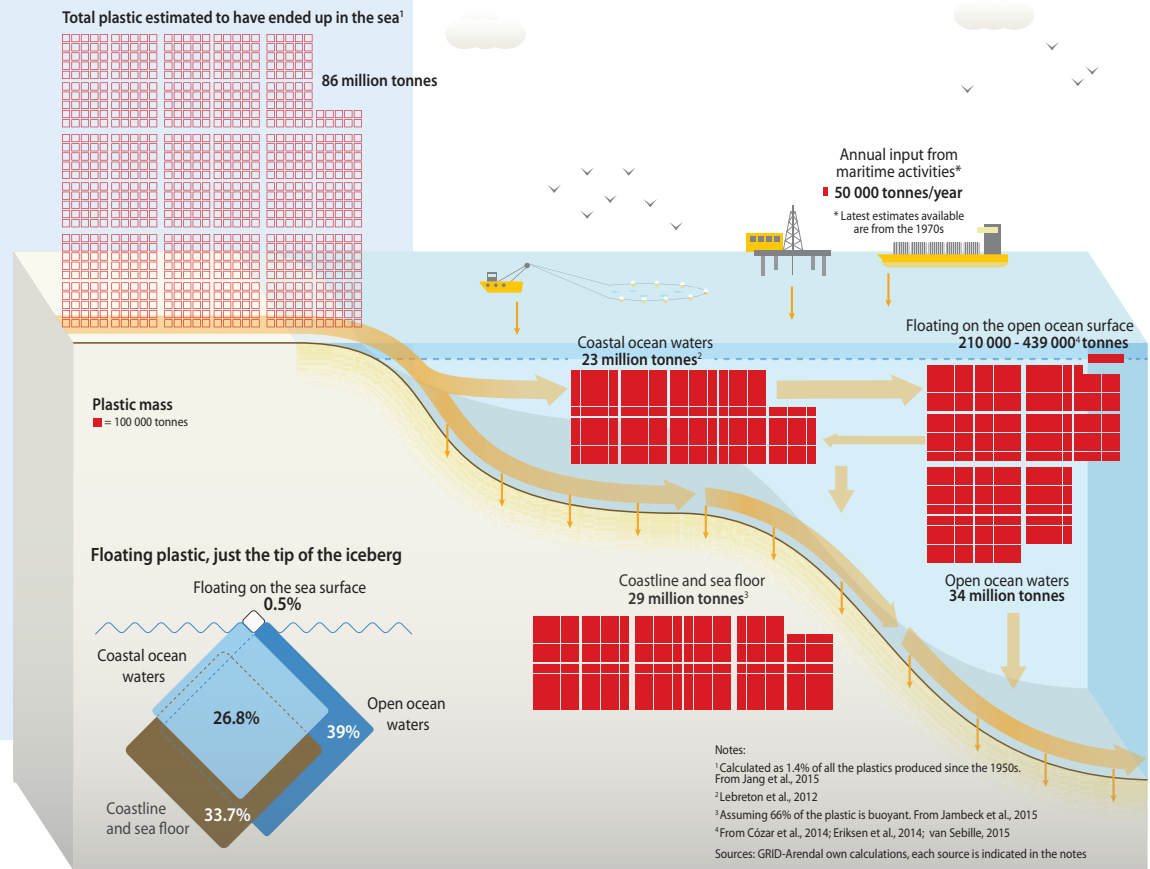

pieces of plastic that measure five millimeters or less. Microplastics may be purposefully manufactured, such as polyethylene microbeads from personal care products or nanoparticles in sunscreen [19] (primary microplastics), or they may be secondary microplastics that come from the breakdown of larger plastics, including microfibers that are shed by synthetic fabrics in the laundry and plastic dust from use of vehicle tires (secondary microplastics). Microplastics smaller than 250 nanometers in diameter are considered nanoplastics.[4]

Best available data indicate that floating macroplastics make up about 233,400 tons [11] while floating microplastics account for anywhere from 93,000 to 236,000 metric tons.[10] Expanded polystyrene foam items were the most frequently observed items (~26 percent) and derelict fishing gear accounted for the bulk of the macroplastics by weight in the ocean (58 percent).[11]

Once they have entered the ocean, plastics end up in nearly every component of the marine environment. Just where a particular piece will end up is determined partly by its characteristics and partly by the movement of the ocean. Plastics that float, such as polyethylene and polypropylene, stay on or near the surface, while denser plastics sink, ending up as deep as the sea floor.[4] Ocean surface currents and wind and wave action transport plastics to the far corners of the world: plastics have been found in the world's most remote waters, on the ocean floor, in sea ice, in sediment, and littering beaches in uninhabited areas. [7] Hot spots of accumulated floating plastics occur in coastal waters adjacent to countries with high coastal populations and inadequate waste management. [10] Other risk factors for high concentrations of ocean plastics in coastal waters are the presence of commercial shipping, aquaculture, commercial fishing, and a high volume of other maritime activities.



## Where Is All This Plastic Coming From?

The best estimate today is that about 80 percent of plastic waste entering the ocean is from land sources and ends up in the ocean as a result of inadequate management of plastic waste.<sup>[1]</sup> Up to 10 percent is lost or discarded fishing gear<sup>[2]</sup> and the rest comes from other maritime sources such as recreational boating and commercial shipping.

Plastic leaks into the ocean at all stages of the value chain: sourcing of raw materials, manufacturing, use and waste, though the bulk of the leakage today is concentrated in the use and waste stages.

The amount of plastic produced in 2010 was about 270 million metric tons, and the amount that became plastic waste that year was similar – 275 million metric tons. Of that, nearly 100 million metric tons was coastal plastic waste, and just under a third of coastal plastic waste, 31.9 million metric tons, is estimated to have

been mismanaged, which resulted in an estimated eight million metric tons of plastic waste entering the ocean that year.<sup>[3]</sup>

The amount of plastic waste entering the ocean is primarily a function of three things: population density, miles of coastline, and amount of mismanaged waste. Since the global analysis used country-level data, a list of countries by input rates indicated where these influencing factors were converging – geographically speaking, nearly 50 percent of land-based plastic litter is estimated to be coming from four rapidly developing Asian countries: China, Indonesia, Philippines and Vietnam. While portions of Asia are where the concentrations are highest currently, Africa may not be far behind. In the top 20, there are 12 Asian countries and five African countries. As African economies continue to develop, if environmental infrastructure does not keep up, these countries will likely be on par with the current leakage rates seen in portions of Asia. But no geography is untouched by this issue.



Figure 2

Plastic Waste Inputs from Land into the Ocean in 2010

Source: <sup>[1]</sup>

**Figure 3**

Plastic Waste Produced and Mismanaged

Source: [20]

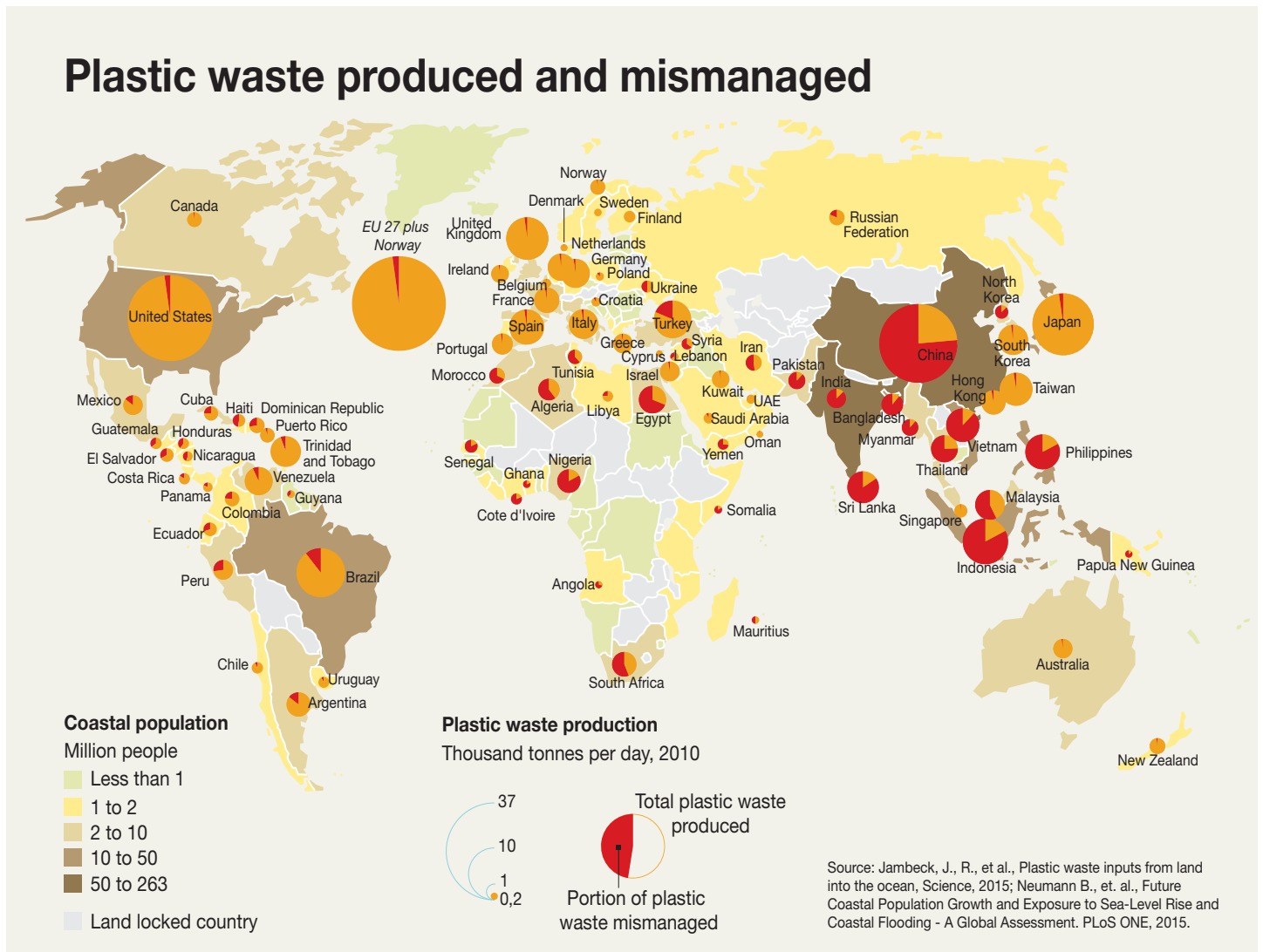

Countries in Latin America and the Caribbean also lack infrastructure and there are specific issues for Small Island Developing States (SIDS). North America and Europe also contribute – though the United States is the only high-income country in the top 20. Although leakage and littering rates in the U.S. are low, the sheer amount of waste is so high that the 2 percent of waste that is mismanaged is still significant in terms of the volume of plastic getting into the ocean. [4]

But no geography is untouched by this issue. Countries in Latin America and the Caribbean also lack infrastructure, and there are specific issues for Small Island Developing States (SIDS). North America and Europe also contribute – though the United States is the only high-income country in the top 20. Although leakage and littering rates in the U.S. are low, the sheer amount of waste is so high that the 2 percent of waste that is mismanaged is still significant in terms of the volume of plastic getting into the ocean.[1]

## Impacts of Plastics in the Ocean

Once in the ocean, plastics persist.

Floating plastic is exposed to UV radiation, higher temperatures, and oxygen, which causes it to fragment into smaller pieces over time (secondary microplastics), but they do not fully biodegrade. Plastics marketed as biodegradable will not biodegrade in the ocean as quickly as they do in the lab conditions they are tested in and, in some cases, they may not biodegrade in the ocean at all. Some products are only oxo-degradable, which means that they fragment faster but do not fully biodegrade, and some biodegrade only under specific conditions - for example, the high temperatures of an industrial composting facility.[4]

Plastics that sink are no longer exposed to UV, heat and oxygen and therefore degrade very slowly, and as a result can remain more or less intact deep in the ocean.

Plastics in the ocean impose steep environmental, social, and economic costs, as described here in more detail.

## Environmental Costs

Ocean plastics are the single biggest debris threat to marine life today – 82 percent of the debris threats to marine life were plastic.[5] Nearly 700 species of fish, birds, sea turtles, sea mammals and other marine animals are known to have been killed by ocean plastic, some in large numbers.[12] When experts were asked which marine debris item poses the greatest risk to marine life, fishing-related gear ranked first, followed by balloons and plastic bags.[15]

Lost or discarded fishing gear is known to damage reefs and other marine environments and it also continues “ghost fishing,” where it traps or entangles fish, turtles, birds and other animals, resulting in injury or death. People who try to save entangled marine animals are also at risk and some have died in the effort.

Marine animals ingest ocean plastics, as they often resemble their food sources, and many starve with their bellies stuffed full of plastics. Those that do survive can have a further challenge: ocean plastics act as a sponge for toxic persistent organic pollutants (POPs) such as polychlorinated biphenyls (PCBs) and polyaromatic hydrocarbons (PAHs), which are present in the ocean. Ocean plastic ingestion can be another route of exposure for animals that are already exposed to these POPs in the water. Further, the POPs can bio-accumulate up the food chain, potentially all the way up to food for human consumption. The human health effects of plastics in the ocean are still unclear and are currently the focus of ongoing research.[3]

Floating ocean plastics have also become a form of transportation for invasive species and microbes, including potentially dangerous pathogens, such as *Vibrio*. [22] As plastic waste shows up in both remote and populated locations, so too do these out-of-place organisms, potentially disrupting local ecosystems and spreading illness and disease. It is worth noting that improperly disposed plastic waste on land may also contribute to the spread of disease by providing standing water for mosquitoes to use as breeding grounds, enabling the spread of diseases such as Zika virus, Dengue fever, malaria and Chikungunya.

## Social and Economic Costs

The short-term social and economic costs are being borne primarily by coastal communities, especially the ones with deposition beaches or near fishing industry, commercial shipping industry, or ocean-plastic-accumulation hot spots. Ocean plastics such as large floating or submerged objects and discarded fishing nets also pose a navigation hazard for all marine vessels.

A 2014 report estimated the financial damage of plastic pollution to marine ecosystems at nearly \$13 billion per year, including financial losses to fisheries and tourism, and time spent cleaning up beaches. The report further acknowledged that it was likely an underestimate.[\[2\]](#)

Coastal communities that rely on tourism have seen millions of dollars of economic losses from ocean plastics. One example is Geoje Island in South Korea, where marine litter is estimated to have deterred over 500,000 visitors, resulting in lost revenue of between \$28-35 million dollars.[\[23\]](#) Many other places around the world have seen similar losses. Cleaning plastics off of beaches is time-consuming and, without volunteers, expensive. The International Coastal Cleanup rallied 800,000 volunteers worldwide who collected 8,167 metric tons of plastic from beaches. This is an impressive amount but unfortunately represents only 0.1 percent of the amount entering the ocean each year. It is worth noting that coastal tourism is also a significant contributor to the ocean plastics problem.

The fishing industry experiences loss of income from ocean plastics through damage to or loss of gear and vessels, reduced catch due to struggling fisheries, and contaminated catch in which plastic bycatch damages the caught fish. One group of researchers studying a derelict crab and lobster pot removal program in Chesapeake Bay extrapolated from their findings that \$831 million in landings could be recovered annually by removing less than 10 percent of the derelict pots and traps from major crustacean fisheries.[\[24\]](#) Further, the industry faces a risk that fish and seafood, even from

remote areas, are increasingly exposed to plastic and toxic chemicals, though there is not yet any conclusive research on the human health impacts of consuming them.

The commercial shipping industry has experienced damage to propellers, damage from collisions with floating containers, disruption of service due to vessel damage and cargo loss due to ocean plastics, with estimates that this costs the industry \$279 million each year in the Asia-Pacific Economic Cooperation (APEC) region alone.[\[25\]](#)

Floating macroplastics, including fishing gear, single-use packaging, and especially large items such as plastic shipping containers, pose marine navigation hazards that can be costly to boats and contribute to accidents. For example in 2015, 195 vessels were involved in collisions with floating or submerged objects that resulted in 16 deaths, 84 injuries and over 2.5 million dollars of damages.[\[26\]](#)

The longer-term economic and social costs of ocean plastics have the potential to be much higher. Assuming plastics continue to accumulate in the ocean, they could become an additional stressor to marine food chains and fisheries already in distress, potentially threatening the human food supply. More research is needed to verify the entirety of these claims, but seafood that is exposed to excess ocean plastic will be more likely to contain microplastics and could be a source of additional exposure to toxic chemicals. The amount of plastic on beaches and along shorelines would increase, likely deterring visitors or imposing huge clean-up costs.

## Taking a Whole-System View

It is essential to take a whole-system view to fully understand both the drivers of – and potential solutions to – plastic waste in the ocean. With this approach, it becomes evident that there is no single solution to this problem. Instead, a portfolio of interventions is required to address the problem across the value chain and to achieve results at different scales and in different time periods (i.e., in the near, medium or long-term). The plastics value chain begins with the creation of plastics in their many forms. These plastics are then made into products and packaging, which are selected, used and ideally reused by consumers. Once consumers are done with these plastics, they become plastic waste for collection and management. Plastics may then be recycled, composted or repurposed, end up in a landfill or dump, or serve as feedstock for WTE. Finally, plastic that has escaped collection and enters the environment may still be captured prior to entering the ocean through last-chance capture.

The system view also highlights the interdependency and, at times, tension between different stages of the value chain. For example, successfully increasing reuse requires products that are designed to be reused, infrastructure that facilitates their reuse, and consumers willing to reuse them. Similarly, when considering waste management solutions, it is essential to consider the entire waste process from collection through recycling, conversion or disposal as an integrated whole.

It is tempting to focus on the last step in this process, where discarded plastic enters the ocean, as the crux of the problem. While this is certainly one place where

intervention is needed, this viewpoint misses the larger context creating this problem: the growth in plastics production, how plastics and products that contain them are designed, used and disposed, and what happens to them at end of life.

There are a number of ambitious projects planned and underway today that seek to clean plastic waste out of the ocean. One of the more advanced projects, The Ocean Cleanup, estimates that their technology can clean 42 percent of the floating plastics out of one gyre (about 70,000 metric tons) in about ten years for an estimated cost of €317 million. However, the plastics floating in the gyres represent only a small portion of the total plastic in the ocean and the amount of plastic successfully removed each year would be dwarfed by the amount being added in.

Rather than directing resources toward cleaning the ocean, investments should instead be made at each stage of the value chain, targeting the systemic causes of ocean plastics and working to prevent the plastic from entering the ocean in the first place.

The potential impact of each investment also varies by the time-scale on which it operates. For example, investments such as cleaning litter out of waterways can have an immediate one-time impact while others, such as developing and commercializing new materials, will take longer to impact the ocean plastics problem but may have a larger cumulative impact over a given period of time (e.g., 10 years).

### PLASTICS VALUE CHAIN





## Intervention Points

There are four fundamental ways to stem the flow of plastic into the ocean:

1. Decrease plastic production
2. Reduce plastic waste generation
3. Reduce mismanaged plastic waste
4. Capture mismanaged plastic waste before it becomes ocean plastic

These four fundamental levers can be employed at various stages across the plastics value chain and may be used individually or collectively.

Each of our seven investment strategies is built on using one or more of these levers to drive a reduction in plastic waste entering the ocean. Below is a diagram of the plastics value chain, as well as an indication of where on that value chain each of these intervention points lies.

**Figure 4**

Four Mechanisms Across the Plastics Value Chain for Reducing Plastic Waste Entering the Ocean

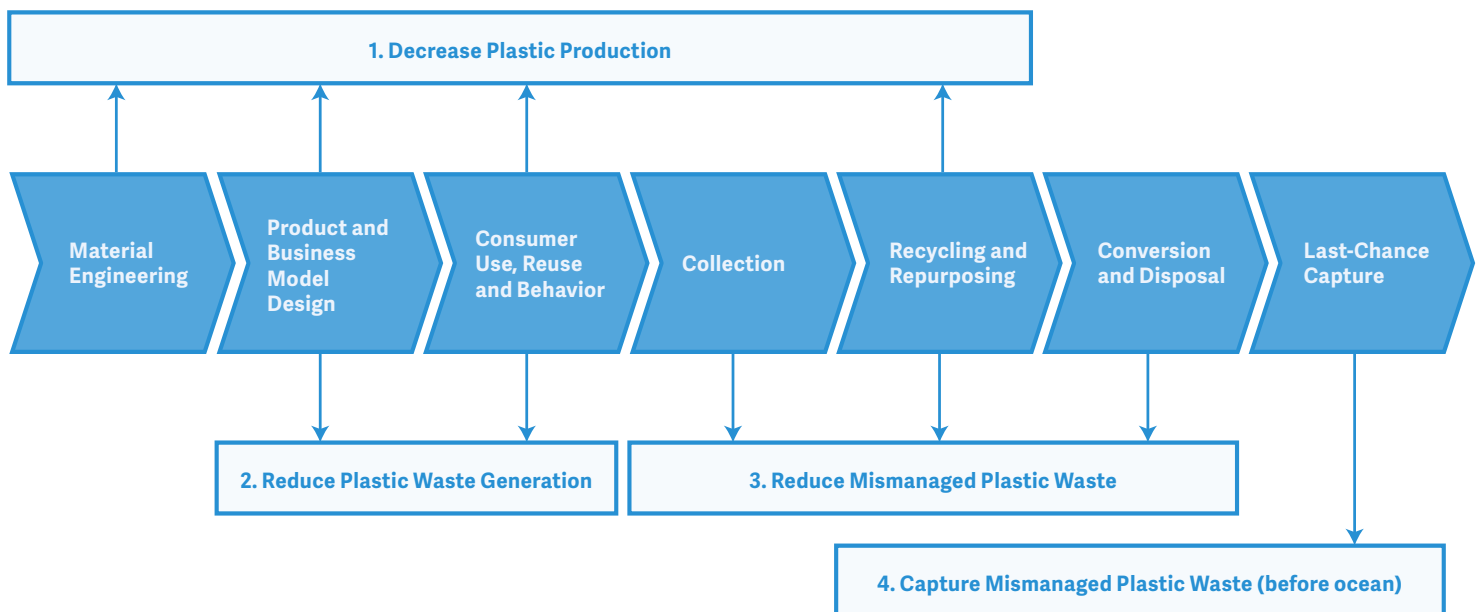

**Figure 5**

Solid Waste Management as a Portion of Total Development Finance

Source: [27]

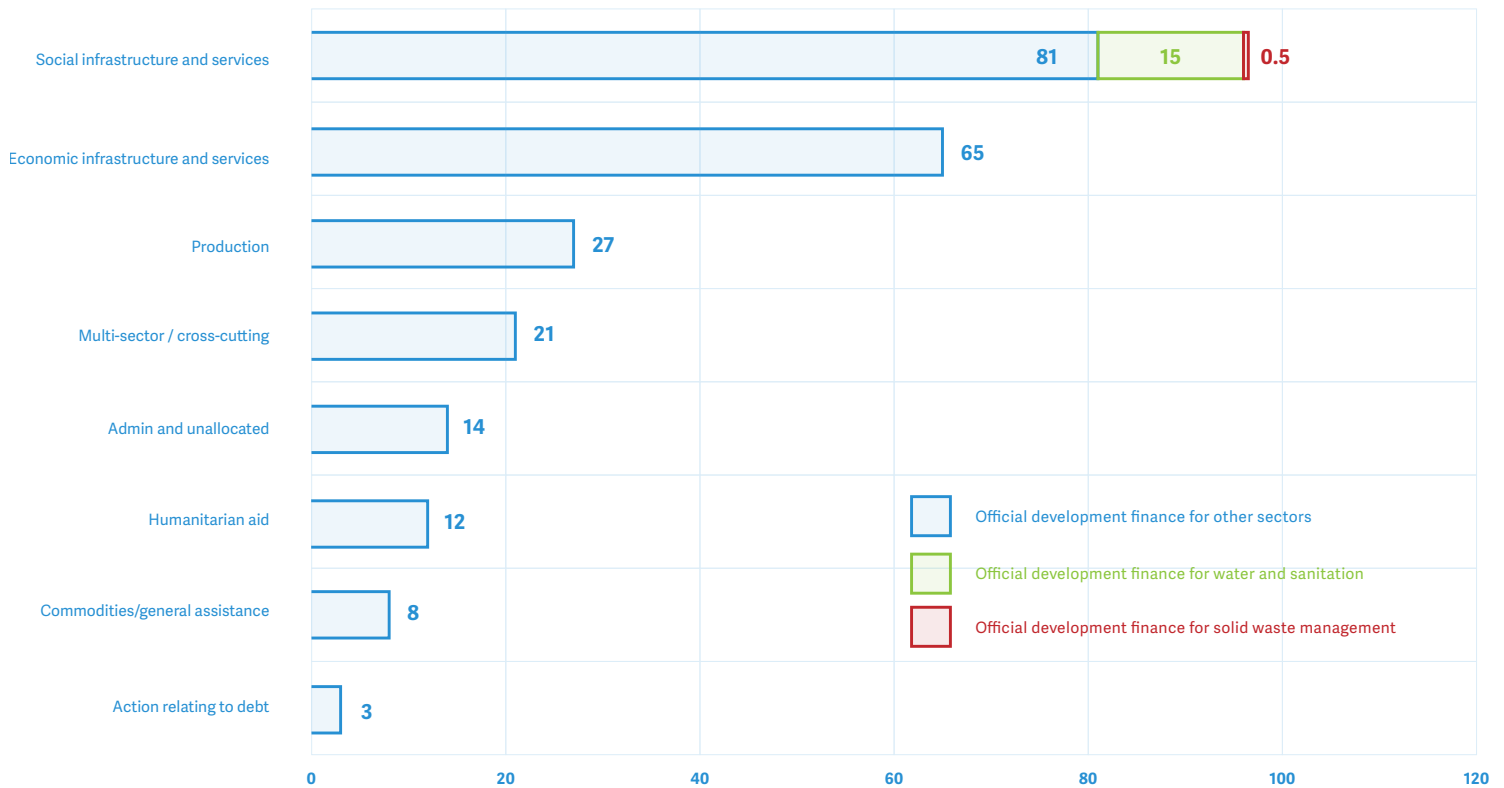

## The Role of Investors

As is detailed in this report, there is no shortage of innovation, entrepreneurial zeal or knowledge of what works. What is lacking, in many cases, is sufficient access to financing to bring solutions to scale. There are additional levers, which are discussed later, but in order to achieve the full-scale change that is required, a significant increase in investment is required.

There are a range of different types of funders who may play a role in tackling the ocean plastics problem: Development Finance Institutions (DFIs), infrastructure investors, impact investors, other private or institutional investors, the private sector, and foundations, philanthropists and other grant funders.

DFIs currently provide financing to support the development of solid waste management

infrastructure; however, it is a tiny fraction of their annual budgets. In 2012, financing for Solid Waste Management was only 0.5 percent of the total funding provided.

The distribution of funds, shown in Figure 6, further shows that funding has not been prioritized for those countries that are the largest contributors to ocean plastics, though China was both the largest contributor and largest recipient. Indonesia and the Philippines received notable amounts of funding, but lagged other similar nations. Africa, with the exception of Morocco, has largely been overlooked for these solid waste management (SWM) investments, though five African countries are already in the top 20 for plastic leakage and their share of the problem will grow with their expanding economies.

**Figure 6**

Municipal Solid Waste Development  
Finance Supports Some But Not All  
High Leakage Countries

Source: [28]

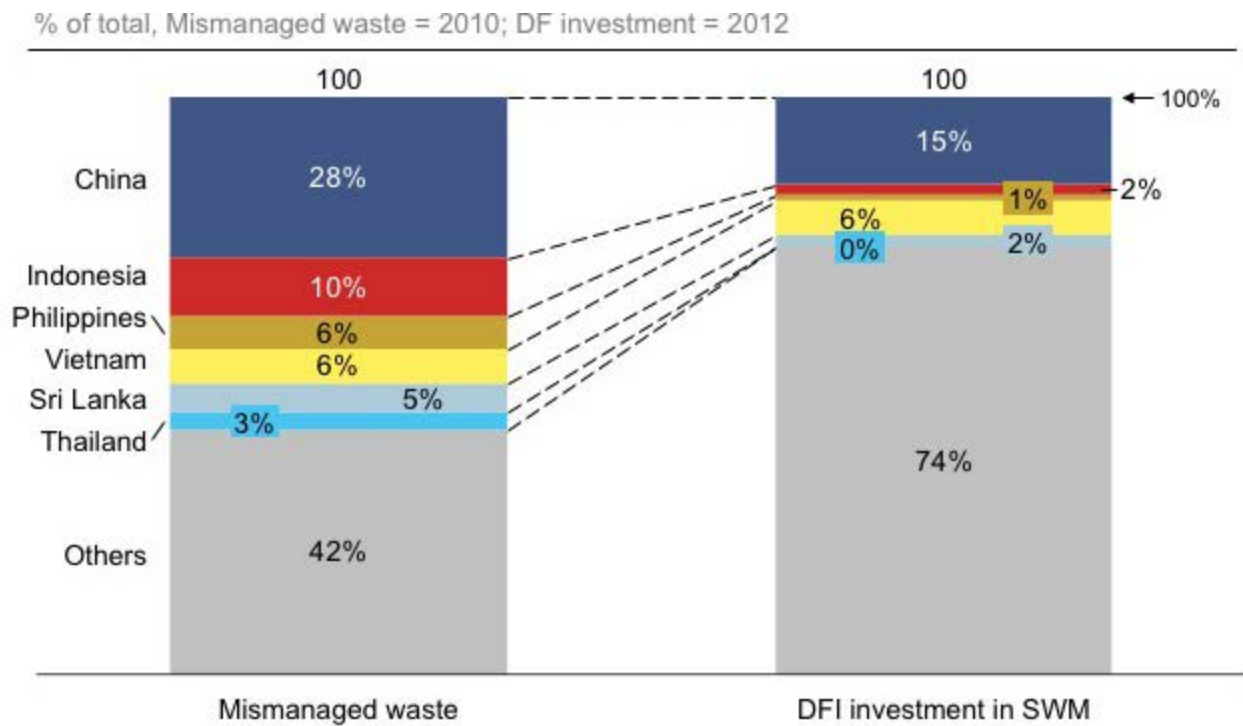

Source: Plastic waste inputs from land into the ocean, Jambeck, et al., 2015; Review of International Development Co-operation in Solid Waste Management; ISWA; 2014

Seven Investment Strategies Across the Plastics Value Chain

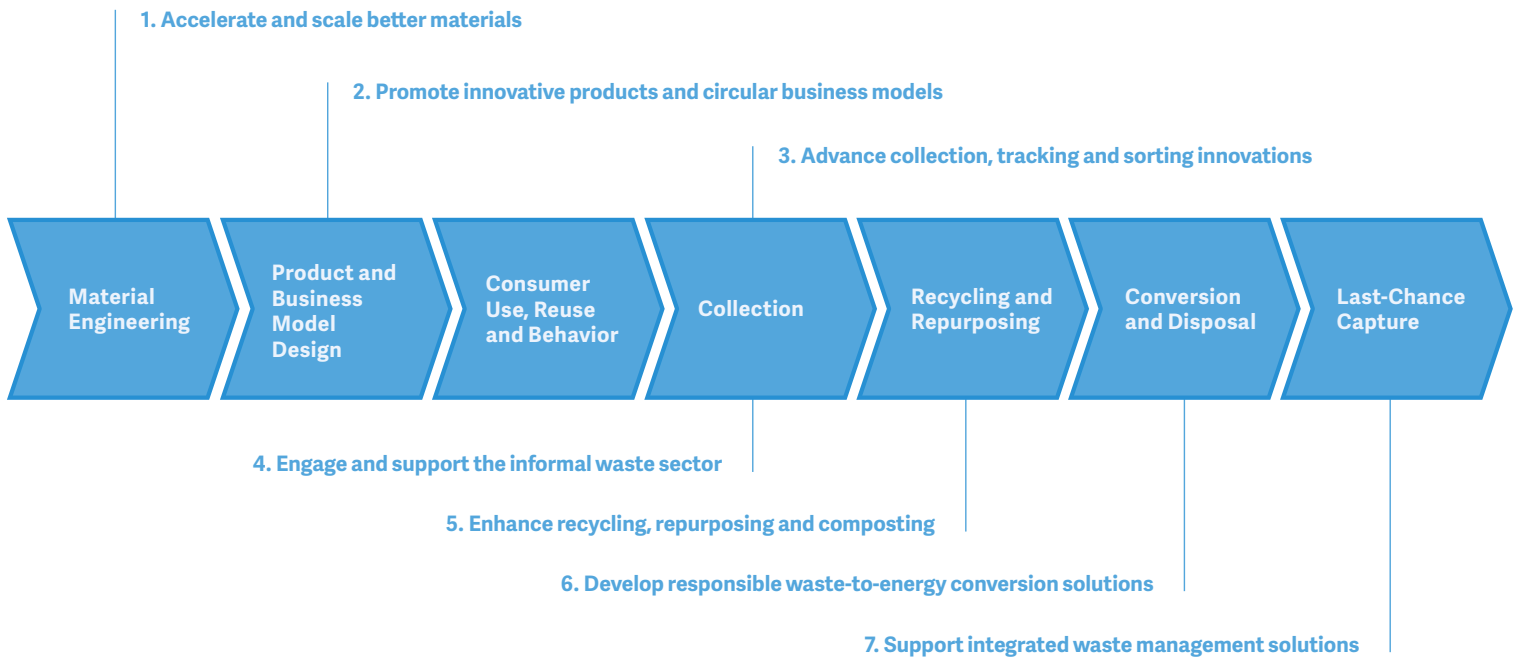

## Investment Approaches

Looking across the plastics value chain, this report identifies the ten highest impact opportunities for reducing the flow of plastics into the ocean. These opportunities form the basis for the seven investment strategies described in detail in this report and the three additional levers, covered at a high level. While recognizing that the plastic lifecycle should be viewed as circular, the seven strategies are numbered in chronological order from material creation to end of life in waste management. The three additional levers apply across various stages of the value chain.

These strategies can focus on entirely upstream solutions that relate to business models, products, and materials or can work in conjunction with the waste management system by improving value capture. There are obvious overlaps between product design and waste management as they relate to recycling and the circular economy.

Across the seven strategies, this report identifies opportunities with diverse objectives and investment criteria for project investments ranging from several hundred thousand dollars to several hundred million dollars.

These seven strategies have been selected because they all provide opportunities for medium or high impact, assessed as cumulative total impact from 2017 through 2026, a ten-year period. Analysis was based on best available or proxy data for each strategy, as data for many of these estimations are currently very limited.

Given the different mechanisms for affecting change, the timing of initial impact varies for each strategy with some having potential for immediate impact and others taking more time for full impact.

**Table 1**

Summary of Impact Investment Opportunities Across the Value Chain

Intervention Strategies	Timing of Initial Impact	Total Potential Impact	Range of Individual Investment Size (Min/Max)	Type of Investment	Geographic Focus
<p><b>1. Accelerate and Scale Better Materials:</b> Accelerate the development and scale-up of better (bio-benign or more readily recyclable), commercially viable materials for packaging and single-use plastic applications</p>	5-10+ years	High	\$500,000 to \$50 million	Early Stage Project or Company Equity	Global Opportunities
<p><b>2. Promote Innovative Products and Circular Business Models:</b> Support companies with innovative products and circular economy business models that enable and promote product and packaging reuse, repair and refurbishment, product-as-a-service, recapture and recycling, and reductions in plastic usage</p>	3-5 years	Medium	\$2 million to \$10 million	Early Stage and Growth Equity, Project Equity	Global Opportunities
<p><b>3. Advance Collection, Tracking and Sorting Innovations:</b> Accelerate the adoption at scale of next generation collection, tracking and sorting technologies that can lead to greater recycling and circularity</p>	3-8 years	Medium	\$1 million to \$30 million	Early and Growth Stage Corporate Equity	Middle- and High-Income Countries
<p><b>4. Engage and Support the Informal Waste Sector:</b> Provide equipment, opportunities and incentives for the informal waste sector in Southeast Asia, Africa and Latin America (“waste pickers”) to enhance their collection of low and high-value plastic waste</p>	1-3 years	High	\$500,000 to \$15 million	Microfinance, Pay-for-Performance Impact Bond	Asia, Africa and Latin America



Intervention Strategies	Timing of Initial Impact	Total Potential Impact	Range of Individual Investment Size (Min/Max)	Type of Investment	Geographic Focus
<p><b>5. Enhance Recycling, Repurposing and Composting:</b> Support the development and scaling of materials and products that use reclaimed or recycled feedstock, creating pull in the system to better capture waste at each stage of the value chain</p>	3-8 years	High	\$2 million to \$25 million	Early Stage and Growth Equity, Project Equity	Global Opportunities
<p><b>6. Develop Responsible Waste-to-Energy Solutions:</b> Provide financing for context-driven environmentally and financially sound advanced WTE technologies, such as gasification and pyrolysis, to underwrite scale-up risk from pilot to first commercial plant*</p>	3-5 years	Medium	\$20 million to \$500 million+	Project or Corporate Equity, Tech-Focused Loan Guarantees	High-Income Countries
<p><b>7. Support Integrated Waste Management Solutions:</b> Provide financing for facilities and/or services that are part of integrated waste management solutions in countries with low rates of waste capture and high leakage in areas of Southeast Asia, Africa, and Latin America</p>	3-5 years	High	\$20 million to \$500 million+	Project Equity, Stacked Financing with DFIs/ First-Loss Investors	Asia, Africa and Latin America

\* Please note: WTE investments require extensive due diligence to assure their economic and environmental viability. There is currently much debate on the role of WTE in waste management and it is out of scope for this report to determine exactly where, how and with what old or new technologies WTE may make sense, but they clearly are a potential solution.

As this report is intended to highlight ways that investment can be targeted to address the ocean plastics problem, it takes only a limited look at additional levers beyond investment that may impact this problem. With these levers, the focus is primarily on interventions that may directly impact investment decisions or spur greater investment in the future.

Philanthropy can be used catalytically in many ways to unlock new investment possibilities. In particular, philanthropy has potential to uncover new solutions through research and development; support higher-risk, high-impact investments; and offer market-altering prizes that may spur new innovations.

Citizens globally can and must begin to make choices that can reduce the problem of ocean plastics. As individuals across the world make choices today that contribute directly to the ocean plastics problem, they also have significant power to stop the flow of plastic into the ocean. Citizens have two main ways to affect change on ocean plastics: 1. change their purchasing choices, and 2. change their own behavior around plastic use and end-of-life waste management. Before they will do either of these things, however, they first have to understand and care about the problem, emphasizing the importance of raising awareness of this issue globally.

Governments are critical actors in the fight against ocean plastics. They can use policy to create the conditions for successful action from material development through the waste management system, engage internationally to support global collective action, and fund efforts that stop the flow of plastic waste into the ocean. In many cases, policies can impact the viability and ultimate success of an investment, either directly or indirectly. Interested investors would be wise to carefully consider the policy landscape relevant to a particular investment opportunity.

This report looks at each opportunity for investment, moving chronologically through the plastics value chain from source through end of life. For each opportunity, an analysis of the key drivers of the ocean plastics problem is provided, followed by a discussion of where investment is needed. In the first half of the plastics value chain – Opportunities From Plastic Source Through Use – the report examines the upstream change levers available today and in the near future, focusing on material engineering and product and business model design. For the second half of the value chain – Opportunities with Post-Consumer Plastics – the report identifies the highest impact interventions, including infrastructure for redirecting plastics back into reuse, recycling, or conversion processes, slowing the flow of plastic into the ocean.

The global challenge of ocean plastics is undeniably daunting, but there is no doubt that investors can, and in fact must, play a significant role in slowing the flow of plastic waste into the ocean.

**Table 2**

Summary of  
Additional Levers

Intervention Strategies	Timing of Initial Impact	Total Potential Impact	Type of Funding	Geographic Focus
<p><b>8. Philanthropy:</b> Use catalytic philanthropy to spur innovation in material design, waste collection, and other sectors</p>	2-4 years	High	Philanthropy and Concessionary Capital	Global Opportunities
<p><b>9. Citizen Engagement:</b> Raise public awareness, facilitate ocean-friendly purchasing decisions, and encourage citizens to make modest behavior changes</p>	1-2 years	High	Philanthropy	Global Opportunities
<p><b>10. Government Actions:</b> Use policy, international action, and government capital expenditures to accelerate change</p>	3-5 years	High	Policy and Government Spending	Global Opportunities

# Impact Investment Opportunities

PART 1



# Opportunities From Plastic Source Through Use

---

**T**he plastics value chain begins with the refinement of crude oil, natural gas or a bio-based feedstock. Resulting hydrocarbons are then heated in a “cracking process” to break down larger molecules into smaller ones. These hydrocarbons are converted into monomers (e.g., ethylene, propylene, and butadiene) that can be used as feedstocks to form chemically repeating structures called polymers. The resulting material resins are used as thermoplastics, and may be molded or formed to produce thousands of different types of plastic products, which in turn are used in a range of ways.

Global production of plastic has increased dramatically since production began in the 1950s from 1.7 million metric tons per year in 1950 to 322 million metric tons per year in 2015, as seen in Figure 10.[\[9\]](#) Demand appears poised to continue robust growth, especially with oil prices at historic lows. Supply is also poised to grow as countries with large fossil fuel reserves look for other ways to monetize their oil and gas in this low oil price environment. For example, Saudi Arabia’s Aramco is in the process of developing partnerships

with large chemical companies such as Dow and Sabic to construct new chemical and plastics manufacturing facilities in Saudi Arabia.[\[29\]](#)

End-use market data in Figure 11 show that plastic was primarily used to make packaging, followed in descending order by consumer and institutional products (including medical), building and construction materials, transportation, electrical and electronics, and other uses, which includes agriculture.[\[30\]](#)

Plastics have done a lot to increase quality of life for people globally – they may be inexpensive, durable, light, waterproof, easily molded, and have many other characteristics which have helped solve human problems large and small since they were invented.

But plastics also bring a range of challenges: reliance on fossil fuels, toxicity and possible impacts on human health [\[31\]](#), and persistence in the environment – particularly in the ocean, where their impacts can be pervasive.



This begs the question: Is there a way to be more intentional and selective in our use of plastic so that the value that accrues to society from its use is ultimately greater than the price society pays? Current research indicates that there is a way to improve the holistic value proposition of plastic – and it starts upstream, in the first few steps of the value chain where material engineering, product design and business model decisions are made. Addressing the problem of ocean plastics, at its current scale and scope, will require that these big levers be pulled boldly – and without delay. While changes in this part of the value chain are high impact, it will take time for their effects to be fully manifested down the value chain and in the ocean.

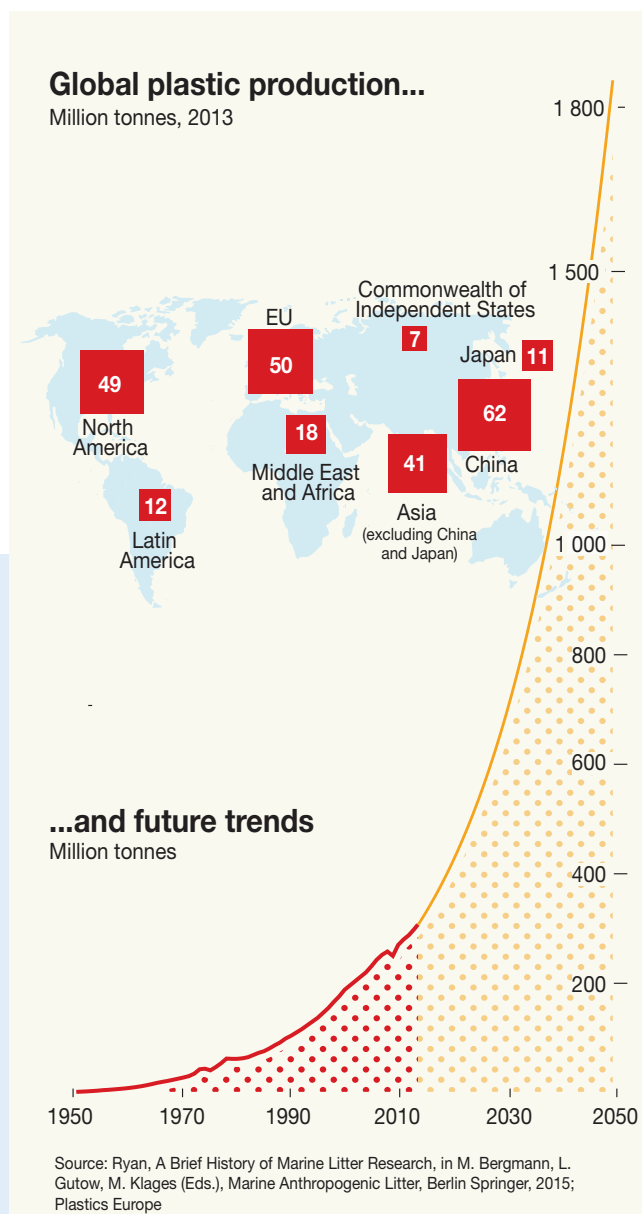

**Figure 8**

Global Plastic Production and Future Trends

Source: [20]

**Figure 9**

Plastic Use Sectors in Europe and the United States

Source: [30]

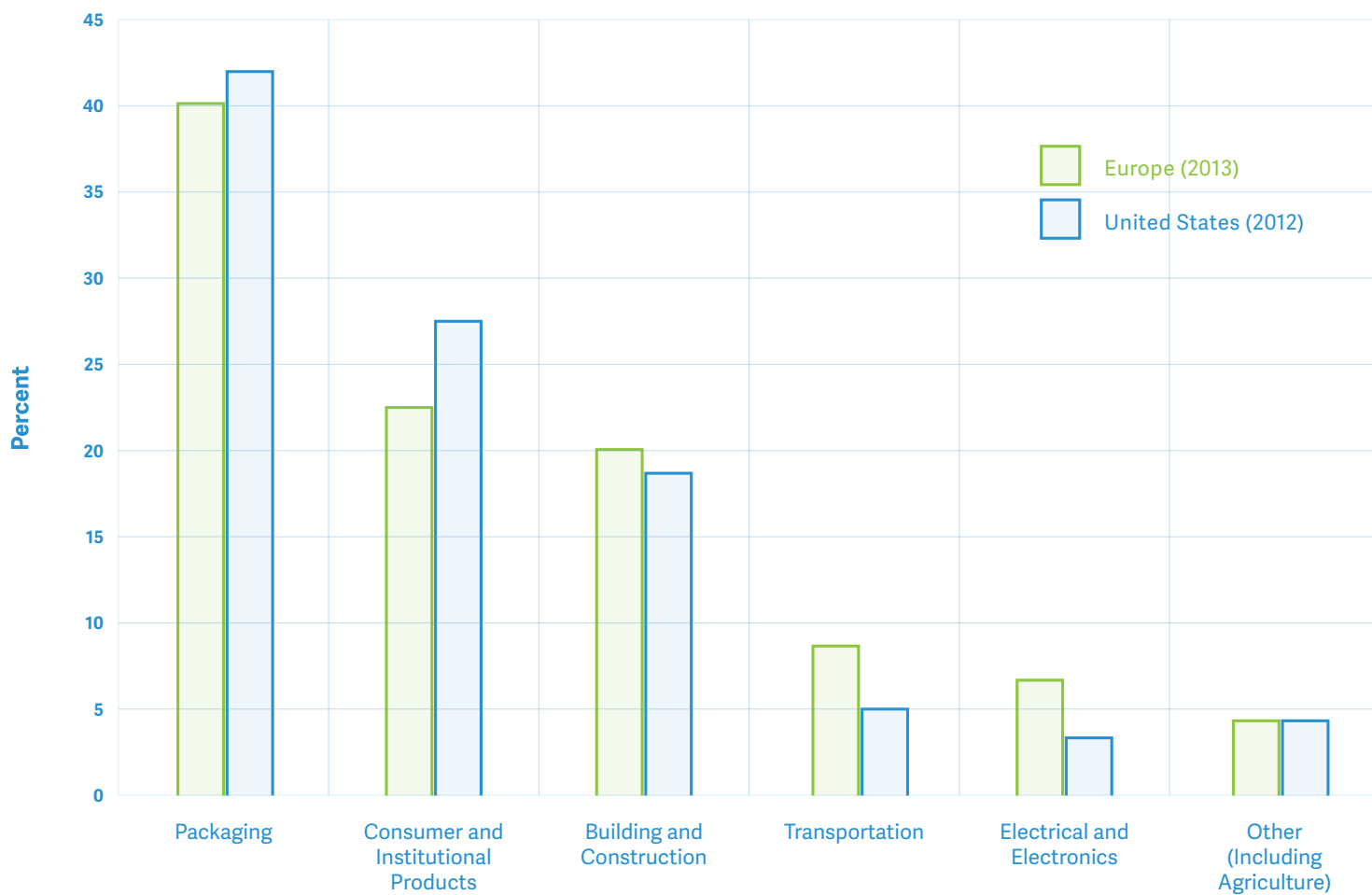

1





# Accelerate and Scale Better Materials

## Investment Focus #1: Accelerate and Scale Better Materials

**Accelerate the development and scale-up of better (bio-benign or more readily recyclable), commercially viable materials for packaging and single-use plastic applications**

**a) Plastics, additives and adhesives that emphasize bio-based feedstocks, are less toxic, biodegrade more quickly and/or are more easily, and are economically and fully recyclable**

**b) Alternatives to current plastics such as wood, bamboo, algae, mushroom, and others**

To know where to focus on material development and engineering, a clear view is needed of exactly what problem needs to be solved. Of the 322 million metric tons of plastic produced in 2015 [9], which types of plastic and which plastic products are ending up in the ocean?

While plastics in the ocean are notoriously hard to study, information on how much and what kinds of plastics are there is improving. A holistic look at what is known indicates that one big lever to address the problem of plastics in the ocean is to choose more appropriate materials for those items that have the shortest lives and are most likely to end up in the ocean: packaging and single-use items.

The waste most likely to be mishandled is waste “on the go,” such as plastic food and beverage containers, plastic bags, and straws/stirrers, along with household waste in countries that do not have sufficient formal collection in place, which includes plastic packaging and single-use sachets of personal care products like shampoos (where these are used).

The top seven waste items most commonly found on beaches were single-use items made of plastic. It makes sense to target these products for replacement with a bio-benign material, where possible.

Litter-catchment systems in harbors and other waterways that empty into the ocean report a similar waste profile. For example, Mr. Trash Wheel in Baltimore Harbor collects mostly cigarette butts, polystyrene containers, plastic bottles, chip bags, grocery bags, and glass bottles.[32]

The Group of Experts on the Scientific Aspects of Marine Environmental Protection (GESAMP) analyzed the land-based sources of ocean plastics and found that the highest-ranked sectors contributing macroplastics into the ocean are retail, food and drink single-use packaging, household goods and the tourism industry. The highest ranked sources of microplastics were secondary microplastics from tourism and single-use food and drink packaging.

**Figure 10**

Top 10 Items Found on Beaches

Source: [8]



**Table 3**

Potential Land-Based Sources of Microplastics by Sector

Source: [3]

Sector	Description	Entry Points	Relative Importance*
<b>Retail</b>	Packaging, household goods, consumer goods	Rivers, coastal, atmosphere	High
<b>Food and drink</b>	Single-use packaging	Rivers, coastal, atmosphere	High
<b>Households</b>	Packaging, household goods, consumer goods	Rivers, coastal, atmosphere	High
<b>Tourism Industry</b>	Packaging, household goods, consumer goods	Rivers, coastal, atmosphere	Yes
<b>Plastic recyclers</b>	Packaging, household goods, consumer goods	Rivers, coastal, atmosphere	Medium
<b>Construction</b>	EPS, packaging	Rivers, coastal, atmosphere	Low
<b>Agriculture</b>	Films/sheets, pots, pipes	Rivers, coastal, atmosphere	Low
<b>Terrestrial transportation</b>	End-of-life vehicles and tires	Rivers, shorelines	Low

\*qualitative estimate, likely to be regionally-dependent; variables include the extent and effectiveness of solid waste and wastewater collection and treatment, and storm water overflow capacity.

**Table 4**

Potential Land-Based Sources of Microplastics by Sector

Source: [3]

Sector	Primary microplastics	Secondary microplastics	Entry Points	Relative Importance*
Tourism industry		Fragmented packaging, household goods, consumer goods	Wastewater, rivers, coastal, atmosphere	High
Food and drink		Fragmented single-use packaging	Wastewater, rivers, coastal, atmosphere	High
Plastic producers	Plastic resin pellets		Wastewater, rivers, coastal, atmosphere	Medium
Retail		Fragmented packaging, household goods, consumer goods	Wastewater, rivers, coastal, atmosphere	Medium
Households		Fragmented packaging, household goods, consumer goods	Wastewater, rivers, coastal, atmosphere	Medium
Households	Personal care and cosmetic products		Wastewater	Medium
Terrestrial transportation		Tire wear dust	Wastewater, rivers	Medium
Cleaning ships' hulls, buildings	Abrasive powders		Wastewater, rivers, coastal	Medium
Manufacturing	Powders for injection molds, powders for 3D printing		Wastewater, rivers	Low
Plastic recyclers		Fragmented packaging, household goods, consumer goods	Wastewater, rivers	Low
Construction		Fragmented EPS, packaging	Wastewater, rivers, coastal	Low
Agriculture		Fragmented films/sheets, pots, pipes	Wastewater, coastal, atmosphere	Low

\*qualitative estimate, likely to be regionally-dependent; variables include the extent and effectiveness of solid waste and wastewater collection and treatment, and storm water overflow capacity.



## How Material Engineering Can Help

Engineering and investment choices being made today will determine whether plastic will become more durable or more degradable, more renewable or more recyclable or both. Given the time required to develop and successfully commercialize new materials, these choices will effectively determine the menu of plastics to be used over the next five to ten years, a critical timeframe for addressing the ocean plastics problem.

There are a range of distinct options for material selection and product design when addressing the problem of plastics in the ocean. Some efforts are focused on minimizing the damage done by plastics that escape collection by promoting universal and full biodegradability (not oxo-degradability), and argue that moving toward biodegradability is a critical and sustainable part of the value loop to keep plastic out of the ocean. Other strategies recognize the critical value of PET bottles to the informal waste sector pickers and recyclers in emerging markets, as well as the utility of recycled PET.

In the long-term, it may be possible for plastics to be both recyclable and biodegradable and all sourced from renewable feedstocks. In the short and medium-term, materials should be engineered for their use, with certain products utilizing biodegradable materials and others focusing instead on sourcing recycled material and using high-value plastics.

This interim solution takes a portfolio approach, where each material is fit for purpose and for context. For example, one might choose a particular biodegradable plastic for cups, plates and utensils that would be used in closed systems such as cafeterias and stadiums where they can be easily captured and sent to an appropriate facility for composting, along with other biodegradable waste. One might continue to use PET bottles but with a stronger emphasis on recycling, either enhancing systems in place today or

implementing new solutions like tracking systems or reverse vending machines. Another choice might be to not use plastic at all for certain single-use applications: for instance, single-use cutlery may be made from edible materials, wood or bamboo and packaging materials may be made from algae or mushroom-based materials.

In a circular economy, materials cycle through a repeating loop and recycled feedstock is incorporated into a new material and used again. However, persistently low oil prices have led to lower-cost virgin plastic resins, which creates a dual challenge for the use of recycled materials. First, there is less of a price incentive to use recycled plastic because the cost of virgin feedstock is equal to or less than the recycled material. Secondly, the lower prices of recycled plastics undermine the economics of the recycling process itself. In places where infrastructure is lacking and the informal waste sector is prevalent, waste pickers will only pick something up if it has enough value. Items left behind by waste pickers, especially in coastal areas, have a high likelihood of ending up in the ocean. One way to keep the price of recycled plastic high enough to be collected is to have recycling processes that can successfully transform it into new, cost-competitive materials. For this reason, the third area of this report focuses on material design and engineering as a means of increasing the use and value of recycled materials.

A robust portfolio of cost- and performance-competitive new and recycled materials is essential to reducing the flow of plastic waste into the ocean. This chapter provides an overview of materials at various stages of development and commercialization that hold promise as part of the solution to the ocean plastics problem.

## Making Plastics Better

Plastics can be either fossil-fuel-based or bio-based, and several plastics can be made from either. There are plastics in each of these categories that are biodegradable. There are also plastics in each category that are recyclable, but plastics that are both biodegradable and truly recyclable have proven elusive, though work is being done to create them. It is not necessarily important that all plastic be both biodegradable and recyclable, but because it is not always clear which plastics are which, both recyclers and composters have a difficult time working with the current waste stream. For example, PLA is industrially compostable, but because it is used in the same applications as PET and is indistinguishable to citizens, it often makes its way into recycling streams, which is problematic. Similarly, traditional plastics that end up in a compost facility will not biodegrade and will impair the overall quality of the compost product.

In 2014, sustainable polymers (broadly defined) made up less than 10 percent of the total plastics market and bio-based plastics were only 0.6 percent of total plastics production.<sup>[33]</sup>

**Bio-based plastics** are sourced from renewable feedstocks such as corn, potatoes, rice, tapioca, palm fiber, wood cellulose, wheat fiber, and bagasse. Some bio-based plastics are chemically identical to fossil-fuel based plastics and are considered “drop in” plastics because they can be seamlessly substituted in existing production processes.<sup>[34]</sup> Many of these drop-in plastics provide environmental benefits such as carbon footprint and upstream pollution reduction, but their disposal and toxicity are no better than their petroleum-based cousins.

**Biodegradable plastics** are able to be decomposed by the action of living organisms, usually bacteria. Not all biodegradable plastics will biodegrade in all situations given current technologies – some require specific conditions like those found in industrial composting while others can be composted at home. Note that

biodegradable does not necessarily mean bio-benign, as some plastics release substances of concern as the material biodegrades.

**Bio-benign** is renewable, biodegradable, and non-toxic.

**The ideal portfolio of plastic and alternative options would include cost- and performance-competitive materials meeting these criteria, where the materials were bio-based to the extent possible in the near to medium term:**

- Backyard/ocean biodegradable plastics for single-use and packaging applications
- High-value recyclable plastics that are easy to identify/sort and are worth collecting (e.g., not too light-weight, single material, no problematic adhesives or additives)
- Biodegradable / water-soluble non-toxic films
- Additives that exclude substances of concern
- Biodegradable adhesives that exclude substances of concern
- Non-plastic, easily biodegradable materials that are suited to their use

This section provides an overview of promising materials at varying stages of development today that have the potential to be part of the solution. As many of these materials are still being developed, and there is the potential for variations within the material types described, this list should be used as a starting point for further investigation rather than an endorsement of any individual materials.

**Figure 11**

Types of Plastic Categorized by Feedstock and Biodegradability

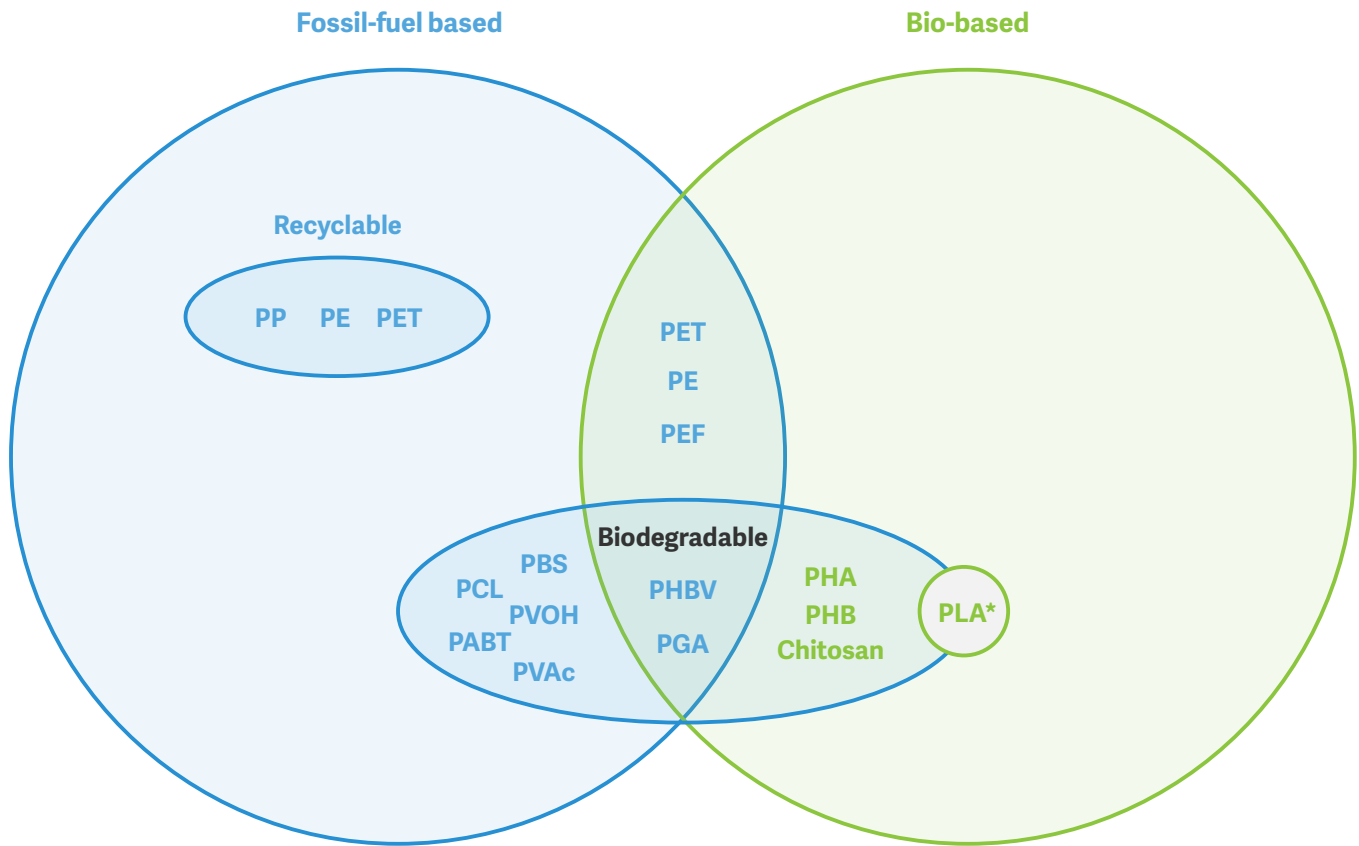

**Note:**

\*PLA is only biodegradable in conditions that allow hydrolysis, like industrial composting (where temperatures allow for hydrolytic degradation, although there are a few enzymes and organisms that can degrade PLA under the appropriate conditions). It is recyclable at high relative cost.



**Table 5**

Overview of Alternative Plastics at Various Stages of Development

Type	Qualities / Applications	Biodegradable	Recycled Today	Other Notes
<b>PHV, PHB, PHBV</b>	<ul style="list-style-type: none"> <li>• Can be used as films.</li> <li>• PHA can be processed on conventional processing equipment, is UV stable and has potential for medical and pharma.</li> <li>• PHB is similar to PP and has good resistance to moisture and aroma barrier properties.</li> <li>• PHBV is less stiff and tougher than PHA and may be used as packaging material.</li> </ul>	Yes	No	Pilot scale / High cost today Inherently difficult to scale Bio-derived
<b>PBAT</b>	<ul style="list-style-type: none"> <li>• Alternative to LDPE and good for plastic bags and wraps due to flexibility and resilience</li> </ul>	Yes	No	Fossil-fuel derived High relative cost today
<b>PCL</b>	<ul style="list-style-type: none"> <li>• Limited mechanical properties (impact resistance, brittleness, etc.)</li> <li>• FDA-approved for biomedical</li> </ul>	Yes, but more slowly	No	Fossil-fuel derived High relative cost
<b>PBS</b>	<ul style="list-style-type: none"> <li>• Alternative to PP, with potential applications in packaging, as film, for utensils or medical uses</li> </ul>	Yes	No	Fossil-fuel derived High relative cost

Type	Qualities / Applications	Biodegradable	Recycled Today	Other Notes
<b>PGA</b>	<ul style="list-style-type: none"> <li>Approved for biomedical uses such as dissolving sutures and implantable devices</li> </ul>	Yes	No	Fossil-fuel derived
<b>PLA</b>	<ul style="list-style-type: none"> <li>Widespread utility, can be processed into fiber or film</li> <li>Similar mechanical properties to PET</li> <li>Not UV stable</li> <li>Can be 3D printed</li> </ul>	Can biodegrade under the right conditions	No	Commercial scale High cost today Bio-derived
<b>Poly (GBL)</b>	<ul style="list-style-type: none"> <li>Alternative to PP, with potential applications in packaging, as film, for utensils or medical uses</li> </ul>	Yes	Yes	Only lab scale currently Bio-derived
<b>Green Adhesives</b>	<ul style="list-style-type: none"> <li>Non-toxic</li> <li>Water-soluble</li> </ul>	Yes	No	Current cost; scalability Bio-derived



**PHA** (*Polyhydroxyalkanoates*), **PHB** (*Polyhydroxybutyrate*), and **PHBV** (*Poly(3-hydroxybutyrate-co-3-hydroxyvalerate)*) are pilot-scale biopolymers produced by material fermentation that have potential for use in medical, packaging, fiber, film, and foam applications. These biopolymers are appealing because they readily biodegrade in environments where bacteria and water are present and can easily be used as films. Points against these materials are their high relative cost today and their limited scale. No one is producing PHA at a large commercial scale yet, though plans are in place to expand as soon as possible at a few PHA production companies. As these efforts progress, there will be an opportunity to increase scale to reduce costs and begin with applications that cater to its current utility. The long-term goal would be to improve utility and then move to production at scale to reduce costs further.

**Fossil-fuel-derived biodegradable plastics** can be cheaper than bio-based biodegradable plastics and can biodegrade relatively easily; however, they are not recyclable and do not confer the upstream environmental benefits from bio-based plastics such as a lower greenhouse gas footprint. Due to the current emphasis on bio-based biodegradable plastics, these fossil-fuel-derived alternatives may have been overlooked to date and could be tapped as a bridge material while other biodegradable polymers are still being fine-tuned. It is worth noting that because these materials degrade by hydrolysis, they are trickier to process at higher temperatures when water is present either for extrusion or 3D printing, which may limit their ability to be used for certain applications.

- **PBAT** (*Polybutyrate*) is typically marketed as a fully biodegradable alternative to LDPE, which is often used for plastic bags and wraps. PBAT is

currently marketed under the brand names Ecoflex, Ecoworld, Eastar Bio, and Origo-Bi. Cost has been a limiting factor but this material is starting to gain momentum which could help drive costs down.

- **PCL** (*Polycaprolactone*) has a low glass-transition temperature and low melting point (-60 Tg and 60 Tm) and has limited mechanical properties (related to impact resistance, brittleness, for example), but it has potential. It has FDA approval which enables its use for biomedical applications where its limitations and higher cost are less of an issue. PCL is currently priced about the same as PLA. While it is fully biodegradable and can be degraded both by hydrolysis (primarily) and enzymatically, it is fairly crystalline, which means it takes more time to do so than other biodegradable plastics.
- **PBS** (*Polybutylene succinate*) could be considered a biodegradable alternative to PP, though currently it is higher cost due to limited production. Researchers are now experimenting with ways to make it using microbes.
- **PGA** (*Polyglycolide*) is most known for its use in dissolving sutures as well as other implantable biomedical devices. It is also being used in the development of food and beverage packaging.
- **PHA** (*Polyhydroxyalkanoates*), when made from natural gas, is still biodegradable and could be used in applications similar to those for bio-based version of PHA.

**PLA** (*polylactic acid*) is the most widespread bio-based plastic today and is appreciated for its broad utility. It is a starch-based bio-polymer used primarily in utensils, cups and packaging. While it is biodegradable, it may biodegrade much more slowly under certain conditions, like in the ocean. Some makers say it is recyclable but at a high relative cost which is prohibitive today. Its current use is limited by high

## Biodegradable Packaging

Biodegradable packaging is likely to be a critical part of the solution to ocean plastics, especially if it can replace low-value plastics that are unlikely to be captured for recycling. For example, a group of students in India is working on designing a 100 percent biodegradable sachet to replace the plastic sachets that are significant contributors to the ocean plastic problem.[\[35\]](#)

## LEGO Looking for New Plastic for LEGO Bricks

In June 2015, LEGO announced a dedicated effort, expected to take up to 15 years, to find more sustainable plastics both for packaging and to replace ABS as the single material used to make LEGO bricks. The goal is that consumers would not notice any change in bricks even when a more sustainable material was substituted for the current material. In 2014, LEGO produced more than 60 billion plastic bricks.<sup>[36]</sup>

costs as compared to traditional plastic, though it is less expensive than PHA, and it does still have some utility issues. Increased use and higher concentration in the waste stream could lead to economies of scale for recycling or could spur greater efforts to capture and compost it. The immediate path forward for PLA is to identify opportunities for ideal uses, such as closed-loop environments where its composting can be guaranteed.

**PolyGBL** (*poly( $\gamma$ -butyrolactone*)) is a breakthrough bio-benign polymer that is also fully recyclable. While still in the early stages of development, polyGBL holds promise as the first bio-renewable and biodegradable plastic that has robust thermal and mechanical properties and can also be completely recycled back to its monomer by simply heating the bulk material to the specified temperature. Next steps for the commercialization of polyGBL include a demonstration of the potential for scale-up and the impact on the materials' physical and mechanical properties, and working with strategic partners and licensees to identify the best initial applications for polyGBL.

**Additives and adhesives** both have significant implications for the use, impact and end-of-life implications of both plastics and other materials.

### Additives

The base polymers used in plastics do not typically present any safety concerns. However, they are almost never used without the addition of compounding ingredients that change their properties to make them better suited to processing and end-use performance. There are over 3,000 types of additives that make

different plastics unique and give them desirable properties. These additives are considered proprietary technology and as such are not currently required to be disclosed.

This is problematic for two reasons. First, they can complicate recycling: additives mean that "PET" or "LDPE" are heterogeneous, which makes recycling difficult and leads to down-cycling. Second, they can contain substances of concern, defined in this report as chemical elements and their compounds that may have serious and often irreversible effects on human health or the environment. This is a particular worry when biodegradable plastics are made using traditional additives, as these substances can dissolve into the environment where they may be ingested by animals, creating a risk of ecotoxicology.

Because additives are used in both traditional and alternative plastics, finding alternatives that are naturally sourced and non-toxic is necessary regardless of which plastic path is followed. However, at present it is difficult to find many existing projects working on "green additives," so there is limited short-term potential for new options. Further research and investment is needed to develop renewably sourced, non-toxic additives. This could be an interesting area for angel or venture investing.

### Adhesives

Adhesives are used both with plastics and non-plastics to adhere different elements together, such as affixing labels to plastic bottles or gluing a cereal box shut. Even though they are used in small amounts, adhesives can complicate or prohibit the recycling of the

## How Low Oil Prices May Drive More Plastic into the Ocean

One critical determinant of the future of plastic production is the price of oil. If oil prices stay where they are or come down further, experts anticipate that there will be a flood of new cheap plastics into global markets as countries and companies look for higher-value uses of their fossil fuel assets. Already, new plastics plants are being developed in Saudi Arabia and elsewhere in the Middle East. Most likely, these plastics will be exactly the ones that are most difficult to keep out of the environment, such as films, further exacerbating current challenges of keeping low-value plastics out of the ocean. Low oil prices also make recycled plastic less cost competitive compared to virgin material and effectively dampen demand for recycled plastics. This discourages the collection of waste plastics, whether by informal waste pickers or by large recyclers. Further, low oil prices can also make it more difficult for innovative new plastics to come online as it takes longer to get to cost competitiveness.

products on which they are used. They also prevent the composting of some materials. One possible solution being developed today is to engineer adhesives to be water soluble so they do not negatively impact pulp and paper recycling operations. Other solutions will also be needed.

### **Developing a comprehensive menu of better plastics**

In addition to these emerging plastics, many other new plastic materials are in the early stages of development in labs around the world. However, to ensure that materials engineers are focused on creating the right solutions, stakeholders who are focused on the ocean plastics problem must align and communicate with those who are creating plastics to ensure the sharing of data related to recyclability and biodegradability. As promising new materials are discovered, significant investment will be needed to further develop, test, scale and successfully commercialize these materials.

### **Alternatives to Plastic**

For some products and packaging, the best option may be to move away from plastic completely.

For these items, there are options both old and new to use: materials such as paper, cardboard, wood, bamboo and materials derived from feedstocks such as mushrooms, algae, edible substances and more. While these are mainly niche products today, many of them have the potential for impact at scale, if they can be successfully commercialized and compete on cost with plastics.

These alternative materials offer a chance for consumer education as well and some of them, such as edible 6-pack rings, have already made an awareness-raising splash as they came to market. As consumer awareness of ocean plastics grows, consumers will start asking questions and expecting companies to have visible solutions. While gimmicks are not the answer, materials that have an engaging story as well as a significant impact could be an important part of the solution.

### **Paper and Cardboard**

Paper is already a viable substitute for plastic in many ways: grocery bags, short-term food packaging, even drinking straws are being made from paper today. And innovators are showing that there remains untapped potential to use paper in place of plastic. Some fast food / fast casual restaurants (for example, Chipotle) are now using containers that are made from recycled compostable paper and are still durable enough to do their job. Cardboard is also replacing plastic in applications like 6-pack rings or other bottle or jar carriers where the added surface area can be used as an additional marketing opportunity for manufacturers.

### **Bamboo and Wood**

Bamboo and wood are renewable, biodegradable and viable substitutes for plastic in a number of situations. For example, wood or wood particles can already replace plastic in wooden coffee stirrers and compostable wooden cutlery, though these items often come at a price premium. Bamboo, fast-growing

and abundant, is already used to make utensils (both disposable and longer-lived), cups, bowls, plates, keyboards, cell phone cases, biodegradable takeaway food containers and compostable packaging. Bamboo is also considered a greener alternative to commonly used packaging materials such as foams, corrugated and molded paper pulp materials. For items being manufactured in China, bamboo is also a locally abundant feedstock.

### **Mushroom**

Material designers at Ecovative have created an innovative process that uses mycelium and agricultural waste to make an expanded polystyrene foam equivalent that is relatively cheap to produce and widely applicable – from low-cost commodity packaging to particle board for construction. It is home compostable and would biodegrade rapidly in the ocean. It is commercial scale and growing, but still at relatively low production levels to date.

### **Nano-Cellulose**

Nano-cellulose is a material made up of nano-size cellulose fibrils, originally derived from wood or other plant material, such as a banana stem. It is able to take a range of forms with diverse properties, and it may be a viable substitute for plastic in a range of applications. The cost to process it is decreasing and, with continued innovation, it may soon be a viable option for certain uses.

### **Edible Materials**

Several companies are pioneering the creation and use of edible cutlery that lasts long enough to eat a meal and then can either be eaten or discarded, when it will decompose in three to seven days. These edible spoons are typically made from flour and water and then baked at high temperatures; one company even lets people make the spoons at home out of any dough they choose. Another edible substitute for plastic is edible 6-pack rings made by a craft brewery from barley and wheat ribbons from the brewing process. They are biodegradable and safe for wildlife to eat if they accidentally end up in the ocean.

Chitosan is a type of fiber made from the hard outer shells of crustaceans that is showing promise as a key ingredient in an edible coating with antimicrobial properties. When combined with starch or gelatin chitosan can help delay spoilage of vegetables. There are also a variety of edible membrane technologies in development or coming to market that have potential to replace plastic in food and drink packaging and preservation, as well as other potential packaging applications. Membranes have the potential to reduce the volume of packaging material needed significantly and open up the potential for radically rethinking how certain products are packaged and sold.

### **Algae**

Marine algae are another promising source of plastic substitute material, in particular to replace plastic water bottles. Marine algae produce agar which can be used to create flexible but strong transparent membranes. These membranes can be used to store liquid such as water and they then biodegrade after use. There is also work underway to use algae to make packaging materials such as bubble wrap.

### **Other Materials**

Other traditional materials like glass, steel, and aluminum could also be used to replace plastic in some applications. These materials offer several benefits over plastic, such as high recycling value, low toxicity, and reusability. Some products, such as Green Sheep Water's canned water, use aluminum cans in place of traditional plastics. These products, however, are often much heavier than plastics, which can add to greenhouse gas emissions. Additionally, they do not biodegrade. While there are some applications where it may make sense to substitute these materials, a full life-cycle analysis would be needed to ensure that they offered a true environmental net benefit to plastic.

## Can 3D Printing Provide the Equivalent of Injection Molding for Non-Plastic Materials?

One advantage plastic has long had over other more environmentally friendly materials is that it could be cheaply and easily injection molded. The advent of 3D printing may level the playing field for alternatives to plastic and enable greater substitution, especially as it becomes more cost competitive. Nano-cellulose has been used successfully in a 3D printer, as have materials as diverse as PLA, steel, wax, silver, titanium, ceramics and nylon.

### Investment Approaches for Material Design and Engineering

Many opportunities exist within the broad sphere of materials development and engineering where investments can make both a compelling return for investors and a tangible impact on ocean health. Advances in materials engineering are being made in labs around the world today and investments can be found in many different countries. Like most investments made this far upstream from ocean-bound plastic, it may be many years before the impact of these investments is felt. However, given the enormous potential for growth in biodegradable / bio-benign materials and natural plastic alternatives, there is an opportunity to realize a financial return far sooner.

**Biodegradable Plastic:** Investing in biodegradable plastic can take many forms, as different biodegradable polymers are at various stages in their product development.

- PHA, PHB, polyGBL, and bio-benign polymers: Companies such as Mango Materials, Full Cycle Bioplastics, and Meridian Holdings Group (MHG) are racing to accelerate the commercialization of truly bio-benign polymers. At this point, however, no commercial-scale, revenue-generating companies exist that focus exclusively on these innovative products. Investors can commit capital to either venture capital investments at the company level or invest in laboratory to small scale production facilities at the project level.

- PLA: While PLA is not a perfectly biodegradable material, its broad utility and conditional biodegradability still make it a significant improvement over the HDPE that it replaces. Furthermore, its usefulness has made it far more competitive in the single-use plastic space for applications like cutlery and packaging. Companies that make these products, such as NatureWorks and MHG, are commercial scale, and the products are ready to be implemented at even greater scale. One problem with investments in this space is that companies making plastics alternatives struggle to compete given the current low price of more traditional petroleum-based plastic.

While multiple early stage startups exist that would make for interesting investments and have the potential to make a long-term impact on the amount of plastic waste in the ocean, significant breakthroughs are still needed for bio-benign plastics. As necessary as these breakthroughs may be for the future of ocean health, market forces have not (and potentially will not) drive their creation. Further research support, whether structured as an investment or a grant, is needed in this space.

#### Other Improvements for Plastics

- **Additives:** Few companies, even small ones, are currently focusing on additives as a way to make plastic either more recyclable or more biodegradable. Instead, this work is being done



in laboratories across the U.S. and elsewhere and currently requires true venture-style investment or, in some cases, philanthropic support.

- **Single polymer plastics:** There are also a number of initiatives taking place, typically within large scale chemical companies, to look at creating plastic packaging that is entirely one type of polymer. This would allow for more simplified recycling. At this point, separate from investments in these large public equities, it seems difficult for investors to access these projects.

### Plastic Alternatives

Many plastic products can be replaced with non-plastic materials altogether. These materials, which are either fully biodegradable, edible, or natural, can eliminate plastic usage altogether for certain applications.

Investment is needed to support further research and development for these and other materials, to pilot larger-scale testing, and to support commercialization at scale for these alternatives to plastic. Further, investment and partnerships are needed to accelerate the adoption of these new materials where they have already been shown to be viable substitutes for plastic.

- **Paper, cardboard, bamboo, and wood:** For many products, such as to-go packaging, utensils, and wrappers, these products are well-positioned to replace plastic and offer limited technology risk. Companies seeking investment in this space range from small startups building niche products to large-scale paper manufacturers seeking new outlets for their materials.
- **Algae, mushrooms, and more:** These plastic alternatives offer more highly engineered and unique materials to replicate the usefulness of plastic. Some example companies include Ecovative, which makes mushroom packaging, and Bakey's, which makes edible cutlery. These companies and others like them are typically private, relatively small, and working to build

a market for their materials as they scale. The companies range from pre-revenue prototypes to more established companies with >\$20 million in revenue.

### Considerations

- **Technology risk:** For companies with an eye towards innovative products, there is a risk that their product will not perform adequately to gain widespread acceptance. This risk is particularly acute given the long product adoption cycle of large consumer packaged goods (CPG) companies.
- **Price risk:** For all of these companies, the key competitor, plastic, is an extremely inexpensive alternative. Many companies are aiming for higher value applications as an entry point to the market, but as they grow they will need to get closer to the price of plastic.
- **Consumer preferences:** Currently, some companies are able to charge a premium for their environmentally beneficial products. This should not be taken as a given and may be challenged in difficult economic times.



2



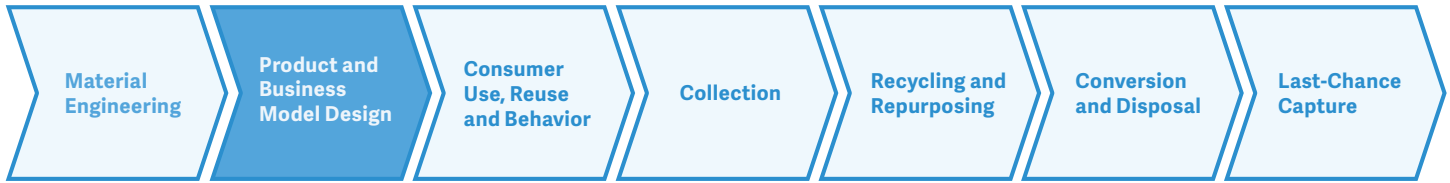

# Promote Innovative Products and Circular Business Models

## Investment Focus #2: Promote Innovative Products and Circular Business Models

**Support companies with innovative products and circular economy business models that enable and promote product and packaging reuse, repair and refurbishment, product-as-a-service, recapture and recycling, reductions in plastic usage**

There are opportunities to rethink how plastic is used today for product and packaging design as well as from the perspective of business model design. Today, designers, entrepreneurs and other innovators are identifying ways to minimize waste, enable more comprehensive collection of plastics at end of life, facilitate recycling, and ultimately staunch the flow of plastics into the ocean.

Consumer demand for ever cheaper and more stylish products has converged with capital markets' expectations that companies constantly grow to create the disposable, consumeristic economy found in most high- and middle-income countries today. This manifests in product design as "planned obsolescence" which can take several forms: contrived durability (where some parts give out more quickly); discouraging or disallowing repairs either through cost, design or warranty conditions; frequent style-driven

updates pushing consumers to upgrade sooner than functionally necessary; or systemic obsolescence, where the supporting components of a product are changed to force a full product upgrade.

Examples abound. Electronics and cell phone manufacturers have been criticized for accelerating the obsolescence of their products with limited backwards compatibility of apps and accessories. Toys increasingly have embedded batteries that cannot be changed once they are depleted. Some apparel retailers have come under fire for the wastefulness of "fast fashion."

Plastic has been a critical enabler of the shift toward disposability as it is so inexpensive that most people have no qualms about throwing it away after a short useful life. This low perceived cost is further accentuated by the fact that consumers do not pay for the externalized cost of plastic use (the cost of collection, the cost of processing, or the costs of its harmful effects on humans and the environment). But many of these products that are now considered disposable still have significant value at the point at which they are thrown away – either for reuse, repurposing or recycling.

The growth of consumption has triggered a similar increase in the amount of packaging being used

and discarded. As one designer observed, designing packaging is essentially “designing waste,” because 86 percent of packaging is discarded after a single use.[\[34\]](#) And yet, instead of simply being a form for transport or catching a consumer’s eye, packaging could one day facilitate sharing or reuse if end-of-life implications were considered when it was designed.

What happens to products at the end of useful life is already somewhat predetermined by the design choices made on the very front-end of the life cycle. To significantly change what happens to used plastic at the end of its life, one must look all the way upstream to both the materials being used (see Materials Development and Engineering) and to product, packaging and business model design.

In many cases, small design tweaks could make products more repairable, recyclable or otherwise less disposable. Packaging, too, could be made more reusable and recyclable – or even biodegradable. In other cases, more significant innovations may be required and should be pursued. New business models can be designed that better capture the value that remains in products and packaging when they would today be discarded. And increasingly, policy is guiding what designers can and cannot do. For example, the EU has implemented a set of policies that encourages designs consistent with a circular economy. (For more information, see “Government Actions”.)

One impediment to improving the recyclability of products has been the lack of a feedback mechanism between recyclers/waste managers and packaging designers. This has been recognized as a need and efforts are being explored to create mechanisms that facilitate dialogue and allow innovation ideas to be surfaced and tested.

Several frameworks offer helpful approaches that can guide needed design changes: green engineering principles, circular economy principles, and Cradle to Cradle design principles. These are a rich resource for designers and, if applied with any regularity, could lead to significant change.

There are six design strategies to inform product and packaging design, with implications for business model design as well:

1. Use less material
2. Design for longer life, repair and refurbishment
3. Enable and promote reuse and refills
4. Improve rates of recapture
5. Design for recyclability
6. Offer product-as-a-service

Additionally, there are also targeted solutions for fishing gear, which has a distinct set of requirements and constraints.

### 1. Use less material

While some companies and governments have been working to reduce packaging waste for the last 20 years, in the U.S., packaging waste still makes up ~30 percent of the waste stream [\[37\]](#), and it is ~40 percent in Europe. While global numbers are not well understood, the packaging sector is likely growing quickly in areas of rapid economic development. One straightforward way to reduce the amount of plastic ending up in the ocean is to use less plastic in packaging and products in the first place. Strategies to reduce material use include lightweighting, redesigning to reduce waste, and eliminating the use of material altogether by not using packaging or by virtualizing products. Reducing the amount of material used often aligns with cost savings as well.

**Lightweighting** makes a packaging item, such as a bottle, lighter by using less material without sacrificing functionality. This has been seen in particular with plastic bottles but can apply to any type of packaging. Success stories emphasize tons of plastic use avoided, a lower greenhouse gas footprint, and financial savings. Unilever tested a new type of plastic in its Dove line in which embedded air bubbles reduced the amount and weight of the material by 15 percent. [\[38\]](#) In one Waste and Resources Action Programme (WRAP) analysis, if all bottles used in the U.K. were one of two specified designs it would have saved 3,400 tons of packaging material and 2.7 million pounds

(approximately \$3.3 million). However, lightweighting has had the unintended effect of discouraging or prohibiting recycling. Less material means less value and the lighter weight bottles are no longer worth enough for informal waste sector pickers to pick them up, causing them to be lost to recycling and/or have a higher likelihood of making their way to the ocean. And some light-weighting strategies use additives or films that render the bottles unrecyclable anyway. Light-weighting can be a helpful strategy for reducing material use but it must be done with awareness of the potential for unintended consequences.

Retailers have recognized the potential to partner with suppliers to **redesign packaging to reduce waste** and find savings. Walmart and Sam's Club combined reduced packaging waste by more than 9 percent in the U.S. and 16 percent in Canada between 2008 and 2013.[\[39\]](#)

Some companies are taking the strategy of **using dramatically less packaging or not using packaging** at all. Higher-end "packaging-less" grocery stores have popped up in several places, offering a broad range of food items for purchase in bulk. Other packaging innovators were inspired by grape skins to create an edible film for frozen yogurt 'pearls' with the goal of eliminating packaging, though they do still come wrapped in paper. A start-up personal care company sells shampoo, conditioner and soap in bar form in a plastic-free compostable package. The bars are concentrated and contain the equivalent of five bottles of liquid product.[\[40\]](#)

As companies sell more products online, they can save money by skipping or greatly simplifying packaging for their products, as the packaging is no longer a reason consumers might choose a product or not. On the other hand, online sales can prompt companies to over-package their items to ensure safe delivery. Whether online or in store, reducing excess packaging material has the potential to reduce plastic waste and likely save companies money.

CDs, DVDs, computer software, books, correspondence, newspapers, photos, and games

have already made a significant shift to existing more often in their digital form than their physical form. This shift is called **virtualization** or dematerialization, which is defined as using less or no material to deliver the same level of functionality. Dematerialization has the potential to avoid the use of significant amounts of plastic and thereby avoid its waste as well.

## 2. Design for longer life, repair and refurbishment

Another way to get more value out of each pound of plastic is by making products last longer and be able to be repaired or refurbished to extend product life. There are companies who have had success with this model for a long time and there are also new examples of innovators applying these ideas in novel ways.

RICOH has designed both its printers and its business model for remanufacture at end-of-cycle. Its GreenLine devices are a re-circulated series of Multi-Function Printers, which are returned from lease contracts and renewed to company standards before being placed with customers again.

Herman Miller's "Design Protocol" considers material chemistry and safety of inputs, disassembly, recyclability and durability (design for repeated use, repair, maintenance, and reassembly using standard parts). These product design choices have implications for the company's business model too: Herman Miller operates a product takeback program to take advantage of this intentional design to repurpose old chairs into refurbished chairs or new chairs made from materials recycled from used chairs.

The cell phone manufacturer FairPhone has designed modular cell phones with a focus on longevity and reparability, and made from ethically-sourced materials. Their promise to consumers is a great phone that has not contributed to human or environmental ills and that they will take back at end of life.

It can be more expensive to design products that last longer and can be repaired, and it makes sense that more durable products would cost more. While it is possible

that higher prices would be a barrier for lower-income people, there are ways to solve this problem other than just making products more disposable – which is costlier both for individuals and for society in the long run.

### 3. Enable and promote reuse and refills

Using reusable product containers and packaging materials is another way to reduce packaging waste. Significant progress in this area will require both innovation in product and business model design and some degree of cultural shift and consumer behavior change. Additionally, policies such as plastic bag bans and deposits on single-use beverage bottles can work to promote reuse. Here are examples of the first part of that equation. The other parts of this equation are covered in “Citizen Engagement” and “Government Actions.”

Reusable grocery and shopping bags have been promoted by many and some stores such as Target and Whole Foods give customers a small discount – 5 to 10 cents per bag – for using their own bags. It should be noted that these incentives cue a behavioral and cultural shift more than being an economic driver of change. However, because reusable bags have been made to be more durable and sometimes use higher-footprint materials like cotton and leather, they are only an environmentally better option if they are reused many times: tote bags made from recycled polypropylene plastic would need to be used at least 26 times and cotton tote bags 327 times, though of course a cotton tote bag would biodegrade in the ocean while the plastic bags do not.[\[41\]](#)

Plastic water bottles have been targeted in particular as unnecessary for most people and easily replaced with reusable bottles. In middle- and higher-income countries, refilling stations for water at stores and airports have been quite successful and some municipalities have run campaigns encouraging drinking tap water and providing more easily accessible information about where to find drinking fountains. In countries where tap water is not always available or safe to drink, some companies are working on providing bring-your-own-bottle water vending machines for an affordable fee.

Some stores allow customers to use refillable liquid containers for anything from water to olive oil to detergent. For example, Green11 and Common Good both offer liquid refills (their container or yours) of personal and home care products. Replenish provides concentrated cleaning agent pods that provide up to three refills in the original bottle. Starbucks offers a small discount for bringing your own reusable cup.

A number of cosmetics companies now offer refillable containers and refills for makeup such as lipstick and eye shadow.

A Finnish startup called RePack is offering online consumers reusable shipping packages for a small deposit, which is then refunded once the shipping package has been returned. This represents not just a product innovation but a new business model as well: customers now pay for the service of a shipping package rather than the package itself. This, in turn, provides an incentive for the shipping company to use that package more than once.

## The Potential of Reverse Logistics

With the rise of ecommerce has come a staggering increase in the number of home package deliveries. What if each time a package was delivered, a previous package, and potentially even some type of waste, was taken away? Increasingly sophisticated reverse logistics could be applied to facilitate the use of reusable or recyclable packaging. Meal delivery services like Plated, Blue Apron, Daily Harvest and others also have an opportunity to take advantage of reverse logistics and reusable packaging with their meal deliveries, though in some cases concerns about sanitation would need to be addressed.



## Historical Inspiration on Design to Improve Recapture

In 1965, ring-tab soda and beer cans came on the market, enabling people to open a can without using a can opener. The ring-tab design allowed people to simply pull the tab to peel off a tear-drop shaped section of the lid. This design worked really well except for two things: people kept swallowing the tabs and when they were not swallowed, the separated ring-tabs were nearly always littered. Can designers considered this challenge and by 1975 they had brought to market the Sta-Tab can design in which the tab did not typically separate from the can. Fast forward to 2016 and the challenges of plastic water bottle caps. Caps are often made from a different material than the bottles. This is problematic for recycling when the little detached ring remains and the majority of the caps separate from the bottle once opened (with the exception of some sport-style caps that stay together). There is an opportunity for water bottle designers to find inspiration in the Sta-Tab story to seek new and innovative solutions for water bottle cap recapture and recycling.

On the B2B side, there are a range of innovations that are enabling significant plastic waste reduction in business to business reusable packaging.

One example is CHEP Pallecon Solutions, which provides rental programs, tracking and management services for reusable dry and liquid containers. Their containers are designed to serve food, beverage, cosmetic, and non-hazardous chemical manufacturers, and are collapsible to minimize the number of trips needed for backhaul.

Many companies have found internal packaging efficiencies as well. Herman Miller created reusable packaging for the shipment of parts during production which both worked better and saved money. Home improvement stores realized a 25 percent cut in packaging use partly through innovations like using reusable bags to ship sofas rather than disposable ones. Cisco redesigned packaging for products and for subassemblies that move between manufacturing sites with positive results.

It is important to ensure that reusable products and business models are set up with the right incentives and safeguards to ensure that a shift to more durable products does not result in more durable plastic waste in the ocean.

There is also potential in commercial and industrial shipping for the use of reverse logistics, combined

with advances in the internet of things and new ways for companies to share shipping packaging and containers. Companies have the opportunity for greater efficiency and cost savings over time, while reducing material waste and sharing risk. For more detail on some of these innovations, see The New Plastics Economy Report, produced by the Ellen MacArthur Foundation.

### 4. Improve rates of recapture

The many ways that plastic waste is brought into the waste management process are covered in detail in “Advance Collection, Tracking and Sorting Innovations.” The focus here is on the specific aspects of design that can facilitate the capture of recyclable items at end of life.

**Tracking technology** has promise for facilitating product and packaging recapture at end of life. Etology is trying to use Radio-Frequency Identification (RFID) technology to track consumer packaged goods (CPG) waste by tagging each bottle or bag with an RFID code that would allow waste management workers to know its content and whether it can be recycled. The technology is not ready for low-value applications yet, but it holds potential for impact long term. Companies like Infinitum in Norway use bar codes to track individual bottles and cans as part of compliance with the country’s Extended Producer Responsibility (EPR) program. There are also potential opportunities to



## Facilitating the Sharing Economy

The sharing economy, or collaborative economy, is another take on the idea of dematerialization by swapping ownership for access. A range of innovative businesses have emerged that facilitate sharing of products from clothes to cars and of spaces from spare rooms to parking spots. The net result of this sharing is a reduction in total consumption and waste. These businesses do not lead to a direct reduction in plastic, but represent a systems change that could eventually reduce reliance on packaging and waste.

- NeighborGoods facilitates sharing of household items via an online platform that aims to provide safety, privacy and security in sharing transactions – while building community.
- ThredUp allows users to swap clothes they no longer want for new ones. Users send in boxes of unwanted clothing, which is sorted and either sent for reuse or repurposing, and then receive a credit which they can use toward 'new' apparel sent in by someone else.
- Yerdle is an online marketplace that enables people to swap or buy/sell used items, enabling products to be reused longer at their highest value. Yerdle also emphasizes the community-building component of their business.

While it is dependent on a user's access to technology and the internet and the availability of sharable things, there remains huge potential to reduce plastic waste through sharing, and there are now several established business models that can be applied to new areas of opportunity.

use infrared tagging, which companies like Calnex are bringing to market.

**Distinctive designs** can also help with product and packaging recapture at end of life, and, with the growth of biodegradable plastics, having easy ways to distinguish one material from another in sorting for recycling is increasingly important. For example, Coca Cola's distinctive bottle shape helps informal waste pickers and recyclers identify it as a reliable source of PET. Distinctive design would also be a helpful tool in keeping PLA separate from PET for recycling, whereas today they are indistinguishable in appearance and PLA can be a problematic contaminant in the PET recycling stream. Other design elements could be used to provide clearer signaling to sorters such as standardized colors or icons to more clearly show at a glance the material used.

**Design for disassembly** can inform product and packaging changes to enable mixed materials to be easily separated to facilitate recycling. For example,

creating products that use both cardboard and plastic with non-adhering cardboard would allow for easy and complete separation once a package has been opened. Both Dell and Apple are now designing their products for disassembly so that at end of life they can easily be separated into their components parts and recycled or re-used.

### 5. Design for recyclability

It is not enough to merely make plastic easier to identify and capture. Companies must take proactive steps to make their products more recyclable to encourage the transition to a circular economy for plastic. At a high level, this is done in two steps: first, by making their products easier to recycle at end of life and second, by incorporating greater amounts of recycled content in their products.

It is well reported that high-value plastics, such as PET drink bottles, are likelier to be captured and recycled than low-value plastics, such as thin plastic bags. Thus,

for products that simply must be made out of plastic, it is important that the material be of high enough value to be recaptured, be easily recyclable, and include recycled content.

Mono-material designs are important to both increase value and recyclability. These designs, which take into account adhesives, colorants and other additives, have emerged as one way to increase recyclability, and can replace products that mix materials today. For example, PVC wrappers are often put on PET bottles and secured with another type of plastic adhesive. This sort of material mixing makes it harder for recyclers to economically reuse material, and makes the whole product less likely to be captured. One example of a step in the right direction is a recent juice box design from Dow that is lightweight, made from only one material, and recyclable.

## 6. Offer product-as-a-service

The Product-as-a-Service approach decouples economic growth from consumption of physical items by shifting the model from ownership to performance-based payment. In other words, people are no longer purchasing things, but rather are purchasing services. In this model, it becomes profitable for the provider of the service to deliver that service with fewer things.

One early example of this concept was in managing the use of agricultural chemicals and pesticides. By switching from selling pesticide as a product to selling weed control as a service, chemical companies were able to increase revenue and decrease costs by using less of their product for a better result, all while decreasing environmental damage.

A more recent example is a novel arrangement to purchase light as a service. Architect Thomas Rau and light bulb manufacturer Philips came up with a “pay-per-lux” lighting system customized for a specific space, at a manageable price. Philips manages how the light is provided and handles all maintenance, reconditioning and recovery for the products used.

Both consumer and B2B offerings can be service-ized. Imagine if, rather than selling boxes and plastic packaging, companies sold a “safe transportation service.” In this model, it would be in the interest of the service provider to use as little packaging as possible to deliver the service and it might even be in their interest to re-use the plastic and the packaging as many times as possible. With strong incentives to minimize the use of packaging, some of these companies might decide to innovate in the design of their packaging in order to maximize value and minimize materials.

## Taking a Comprehensive Approach to Product and Business Model Redesign

Some companies have taken a proactive approach to shifting toward a circular economy. Here are two companies who have shown a clear commitment to rethinking how plastic is used and reused.

- Unilever has embraced circular economy thinking and is putting all of these strategies into practice: modular packaging, design for disassembly and reassembly, wider use of refills, recycling, and using post-consumer recycled waste. Unilever has committed to pursuing one major project in each of its four product categories and sharing the insights and results across the company.
- Aveda has been a sustainable packaging leader in the health and beauty industry since they developed their first Aveda Packaging Guidelines in 1991. Notable accomplishments include pioneering the refillable lipstick container, makeup items with innovative minimal packaging, a commitment to use post-consumer recycled content in all packaging, and various attempts at packaging takeback, where they are continuing to innovate and test.

## Investment Approaches for Business Model and Product Design

This category includes a very broad range of companies and could accommodate many different investment approaches, from venture capital investments in new and innovative companies, through growth-equity or listed-equity financing for more established firms, all the way to debt or equity investments in the infrastructure these firms will need to grow their operations.

There are four categories of companies identified as most relevant for investment with the objective of catalyzing and supporting innovation in product and business model design:

- **Small to large packaging companies** that are innovating on using less material and using better materials. This includes startups like Ethique and large companies such as Walmart.
- **Product design firms** that are using green design principles in their designs.
- **Innovative start-ups** focused on enabling the circular economy – from reusable containers to product sharing to product-as-a-service – both for consumer and commercial/industrial users. This is a young industry with diffuse goals. There are companies like Green Garmento, making reusable laundry bags to replace single-use cellophane; Fairphone, making easily repairable and recyclable cellphones; and Reusable Transport Packaging, seeking to replace single-use shipping pallets and containers.
- **Large companies** like Unilever that have embraced some or all of the principles of the circular economy and are working to test and implement them, or other CPG companies that could be pushed in this direction

### Considerations

- Given the diffuse nature of innovation and progress toward the circular economy, this is an area where it may make sense for investors to also take a broader approach and use mechanisms such as ESG reporting to drive change. Sample metrics might include: packaging intensity ratio, recyclability or biodegradability of packaging, repairability, reusability, estimated length of actual useful life compared to potential for useful life given durability, lifespan of component parts, residual value at end of useful life, or even more simply, plastic use per unit of revenue. Groups such as the Plastic Disclosure Project are aiming to do just that for a set of criteria related to plastic use and waste generation. If investors pushed for disclosure of a set of new metrics that provide insight into how much each company is contributing to ocean plastics, this would then enable all investors to take these data into account in their decision-making.

## Solutions for Fishing Gear

Abandoned, lost or discarded fishing gear (ALDFG) can continue to catch and kill marine life for decades (known as “ghost fishing”). Roughly 70 percent (by weight) of macroplastics floating in the open ocean are fishing-related, though this also has to do with the various densities of types of plastic.[11]

Today, almost all fishing gear is made with materials that do not biodegrade in the ocean. Some materials will break down from solar radiation and slow thermal oxidation into smaller pieces, which remain a hazard to marine life but will not continue ghost fishing.

There are three main solutions today to reducing the amount of gear being lost or discarded and minimizing the damage this gear can do once loose in the ocean.

First, people fishing should try to lose less gear. It is essential that they use gear marking to identify ownership and increase visibility, technology to avoid unwanted gear contact with seabed, technology to track gear position, and gear technology to reduce gear loss.[42] These regulations could be added to new and existing rules on over-fishing and other types of marine pollution.

Second, the fishing industry should use products that biodegrade. Truly biodegradable polymers that met performance requirements would be the ideal solution; however, designing polymers that degrade in the ocean only when they are not actively being used presents clear challenges.

This technology will need to advance over time. In the interim, some products being used today are oxo-degradable, which means that the plastic fragments in a couple of months. It is important to note that while these products can help reduce ghost-fishing, they are not acceptable solutions from an ocean plastic perspective. Once the plastic has fragmented, it still contributes to microplastic pollution in the ocean.

Third, marinas or others can provide incentives for fishermen to collect gear they find. Incentives can range from offering free or subsidized disposal of recovered gear to monetary compensation for bringing in nets or gear, especially in “off” season for actual income. The Net Works program in the Philippines aggregates fishing nets collected by local people for an income and they are then used to make carpet at Interface. Net Works is looking to expand elsewhere and to incorporate other forms of plastic waste. Likewise, the Steveston Harbor Net Recycling Initiative collects nets and ships them to an ECONYL plant in Slovenia to be made into carpeting and clothing. In the U.S., NOAA MDP sponsors Fishing for Energy where nets are collected from marinas and then combusted for energy recovery in Hawaii and on mainland United States.

There are a range of efforts underway that seek to address this issue. The Global Ghost Gear Initiative (<http://www.ghostgear.org/>), for instance, is a cross-sectoral alliance that drives solutions to the problem of lost and abandoned fishing gear worldwide. They are currently supporting almost 20 projects focused on research, awareness and removal of ghost fishing gear all over the world.

# Impact Investment Opportunities

## PART 2





# Opportunities With Post-Consumer Plastics

---

## Overview

Once plastic waste has been created through the disposal of products at end of life, the key to keeping it out of the ocean is effective waste management. There are significant differences in the availability and quality of waste collection and management systems across countries and even across different cities or regions of the same country. At the end of the day, while it has global implications, waste management is fundamentally a local process.

The central challenge of effective waste management is an economic one: in most of the highest polluting countries, there is either an inability or an unwillingness to pay for waste management as a public service. In places where there is an ability to pay, this is addressed through fees for these services paid by citizens, businesses and government. In places where the government does not pay these fees and does not enforce that citizens pay for it themselves, the result is gaps in waste management and leakage of plastic waste into waterways and the ocean. This varies within

countries and even within municipalities, as some cities and neighborhoods are much better covered than others.

In these cases, many groups are looking at ways of extracting enough value from the waste to cover the cost of its collection, treatment and disposal. Other groups are considering drastically different models of collection that are less expensive and can be supported either through government or user payments. Still others are looking at converting these municipalities into so-called “zero waste” zones.

In spite of the clear need, investment has been weak in waste management systems in lower-income countries both from development banks as well as private investors due to the challenging economics and the political, business and other risks that need to be managed.

The second half of this report identifies opportunities to expand waste management services in order to capture more of the plastic that is being used. This is



**Figure 12**

Urban Waste Generation by Income Level and Year

Source: [43]

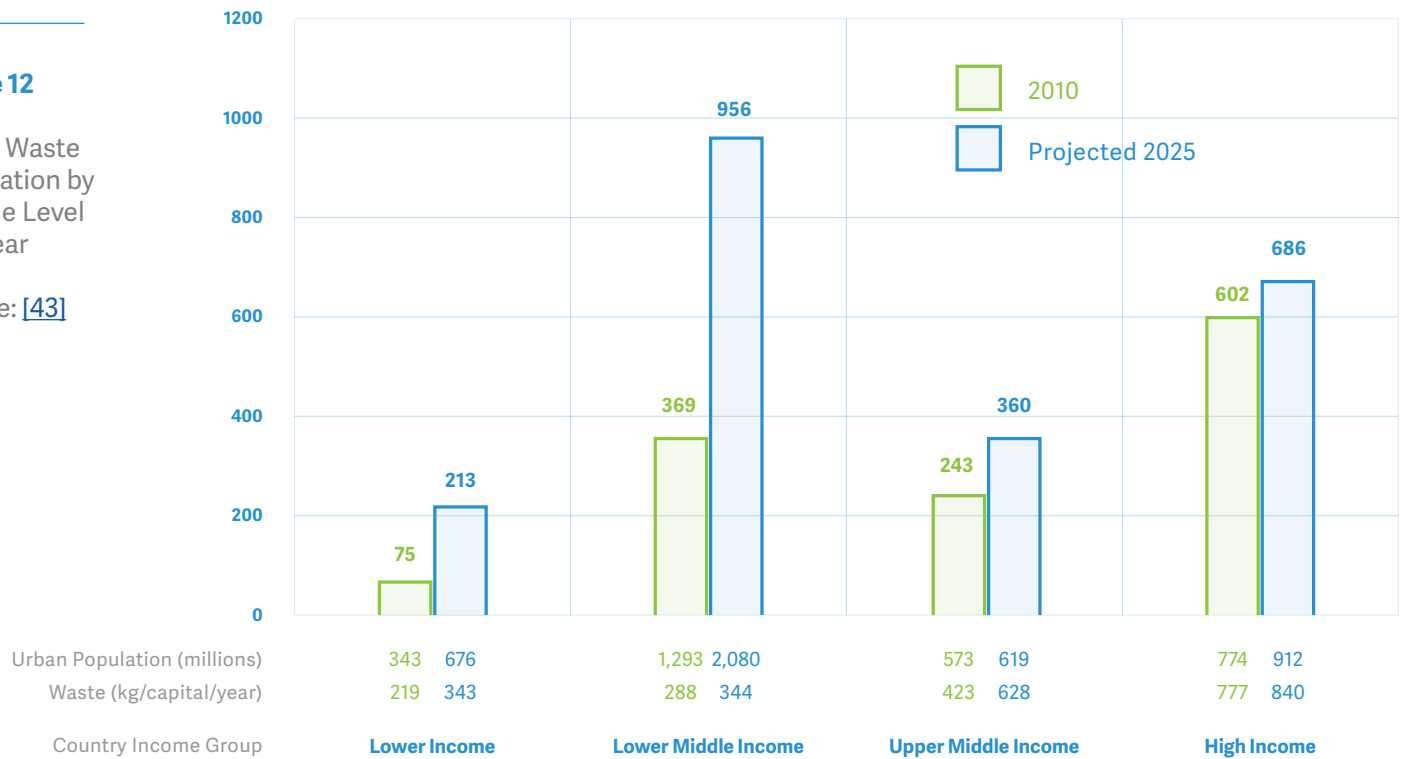

not meant to counter the recommendations in the first half of the report, as there will both be a timing gap before bio-benign alternatives are commercialized and scaled as well as a residual amount of plastic that will remain in use far into the future. In other words, it is not a question of an “either-or” approach, but rather a “both-and” approach.

The models considered either extract more value from waste at each stage of the process or empower the informal waste sector to create less expensive and more efficient waste management solutions. Both of these methods have the potential to create economic incentives for improved waste management services overall, and different solutions will be needed in different contexts. For example, investments in high tech sorting equipment may only be feasible in high-income countries, while other integrated waste management solutions are designed specifically for lower-income countries.

In collection and sorting, increased efficiency through new technologies can lower costs and increase resource recovery, improving the economics. Empowering the informal waste sector pickers

through microfinance and other investment programs can enhance the recovery of waste plastic while improving the livelihoods of some of the most vulnerable populations on the planet. For recycling and composting, enhancing recycling technologies and strengthening the markets for recycled and composted materials can improve revenue potential. WTE solutions, while controversial given their potential for environmental harm and high costs, offer the potential to bring more revenue into the system, which could be a driver for waste collection. And finally, considering the waste management system as an integrated whole may reveal opportunities for investment in high-polluting geographies.

### Waste Around the World

The amount of total waste being generated globally is large and growing. Globally, estimates from 2010 put the total amount of waste generated per year at 2 billion metric tons.[17] The World Bank estimates that there were 1.3 billion tons of waste produced by urban residents, with this number projected to increase by 2.2 billion tons by 2025.[43]

**Table 6**

Municipal Solid Waste Collection Rates Summarized by Income Level and Region

Source: [43]

Income Level	Summary by Income Level		
	Number of Countries Included	MSW Collection (%)	
		Lower Limit	Upper Limit
Lower Income	13	10.62	55.00
Lower Middle Income	20	50.20	95+
Upper Middle Income	27	50.00	100.00
High Income	35	76.00	100.00
Total	95		

Region	Summary by Region		
	Number of Countries Included	MSW Collection (%)	
		Lower Limit	Upper Limit
Africa	12	17.70	55.00
East Asia and Pacific	6	60.00	100.00
Eastern and Central Asia	12	50.00	100.00
Latin America and the Caribbean	28	10.62	100.00
Middle East and North Africa	10	55.60	95+
Organization for Economic Co-operation and Development	26	76.00	100.00
South Asia	1	94.00	
Total	95		

On a per capita per day basis, the countries of the OECD have the highest rates of waste generation, with levels that are twice the amount of waste as other regions and nearly five times higher than the lowest (see Figure 17).[43]

Among high-income countries, New Zealand leads with per day per person municipal solid waste generation of 3.68kg, followed by Ireland (3.58kg), Norway (2.80kg), Switzerland (2.61kg) and the United States (2.58kg).[44]

Waste generation has traditionally been correlated to economic growth and it is growing fastest in rapidly developing countries. In fact, the World Bank projects waste generation to grow 159 percent in the lower-middle-income countries between 2010 and 2025. Given that lower-middle-income countries also tend to have lower than average collection rates, this large increase in waste is at high risk for entering the ocean.

About 11 percent of this waste is plastic, which is 275 million tons in total and 143 million tons in urban areas. The percentage of plastic in the waste stream is lowest for low-income countries at 8 percent and highest for lower-middle-income countries at 12 percent. Both middle- and high-income countries are at 11 percent. [43]

## The Waste Management System

The waste management system begins with collection, which includes public or private waste haulers collecting from households, businesses, citizen drop-off centers and “on the go” public trash cans. In countries that do not have sufficient formal waste collection, waste may be thrown in the streets, collected by waste pickers, or taken to informal dumps where waste pickers extract the high-value items, including some plastics.

Figure 13

Potential Paths for Plastic Waste

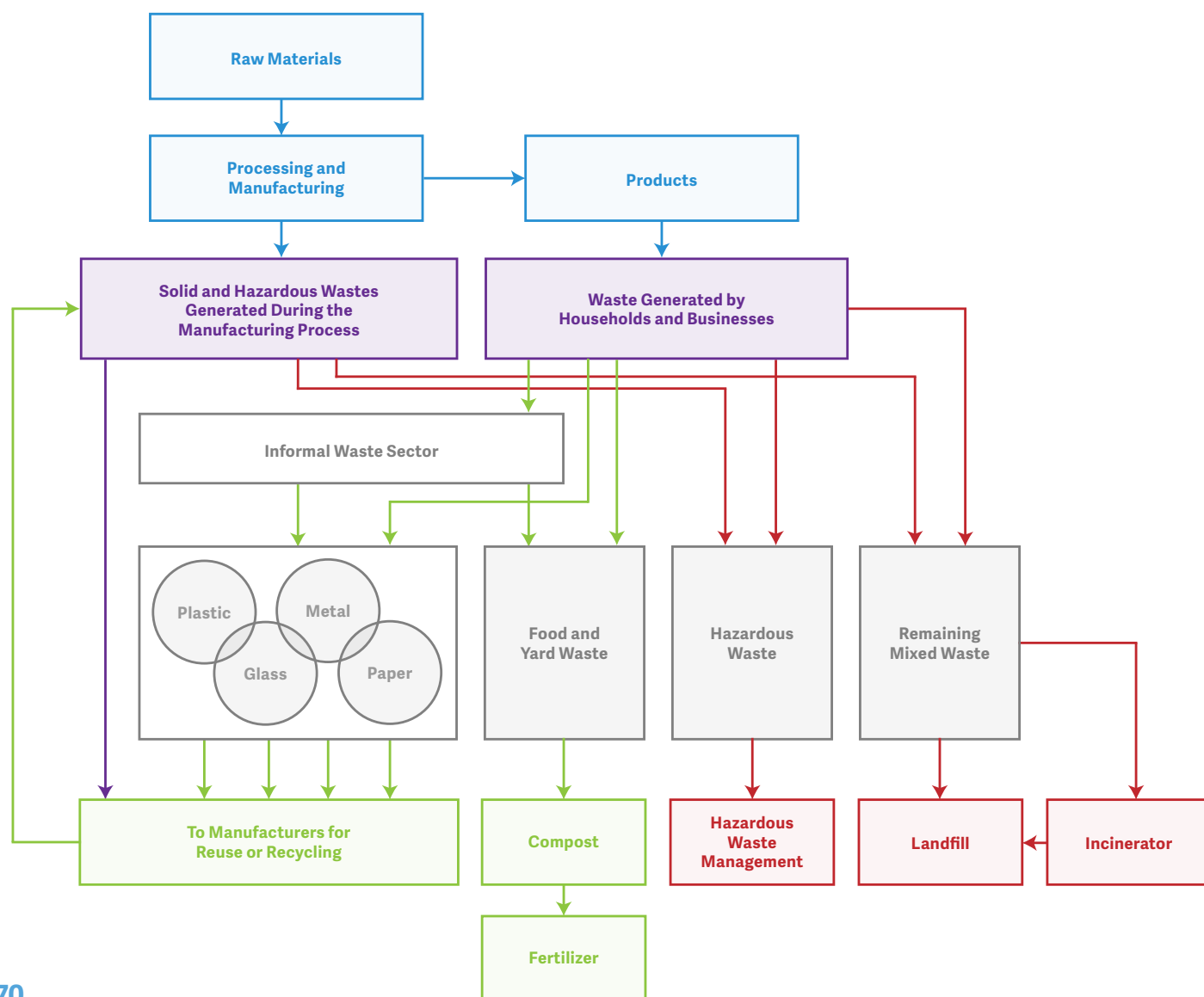

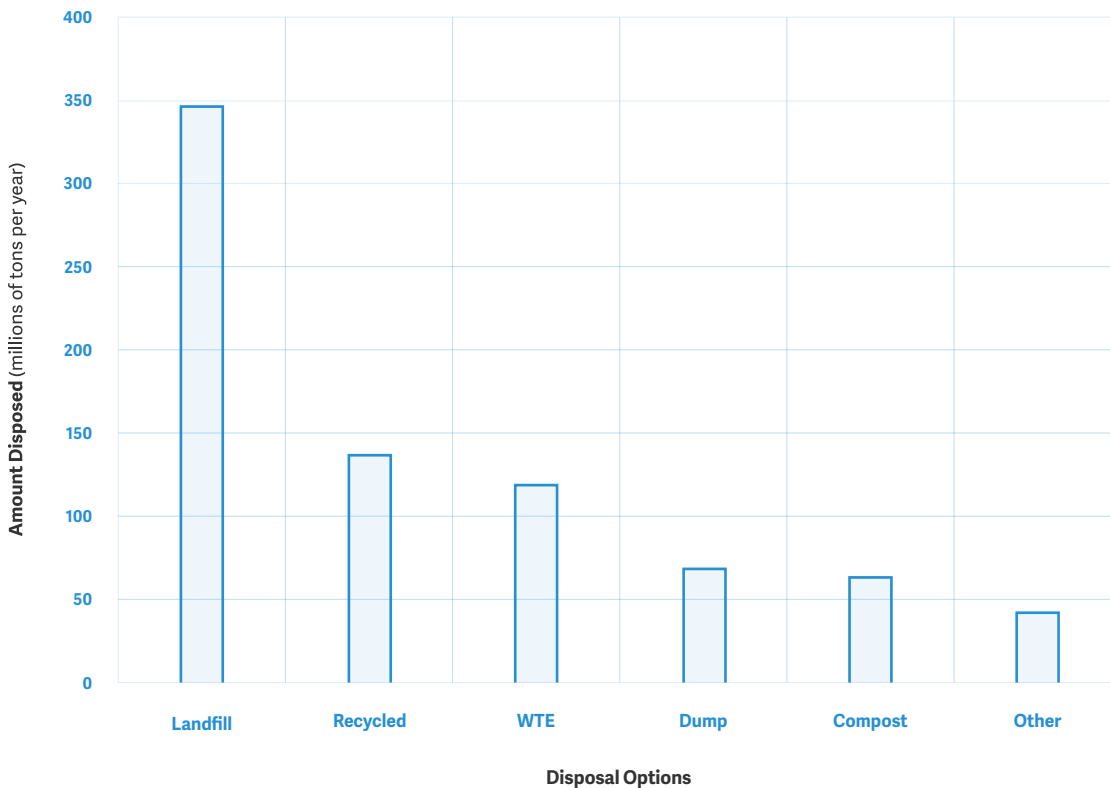

**Figure 14**

Total Municipal Solid Waste Disposed of Worldwide

Source: [43]

Not surprisingly, collection rates are correlated with country income level. However, there is variability, even among countries with similar income levels. Among lower-income countries, collection rates range from as low as 11 percent in Haiti to an upper limit of 55 percent in Sierra Leone. Some lower- and upper-middle-income countries get to 95-100 percent collection, but many fall far short of that. Among high-income countries, the vast majority are at the 99-100 percent level, but a handful of countries such as Ireland, Hungary and Estonia are in the 70s.

Plastic waste that is collected can take one of several paths. If it is collected for recycling or as part of a Wet/Dry segregated system, it will go to a Material Recovery Facility, or MRF, where it will be sorted (sometimes with the help of informal waste pickers) and routed to a processor and eventually be a material for new products. If it is being disposed, it will go directly to a landfill. For source-separated compostable plastic, it can go to an industrial or commercial composting operation, but this is currently very rare. It should be noted that globally, and especially in areas that lack regulation or enforcement of regulations, collected waste can be illegally dumped and end up in the environment.

Uncollected high-value plastic waste that is dumped in the street or an open dump has a chance of being collected by a waste picker, who will then sell it to an aggregator or a recycler. Low-value plastic does not often get picked up by pickers because the value is truly too low or because aggregating a worthwhile amount of the low-value material is difficult. If it does not get picked up, it either stays on land or gets washed into waterways and the ocean.

### Final Destination

Collected waste ends up meeting one of six fates: recycling/repurposing, compost, conversion to energy and/or other value-added products (e.g., diesel, monomers), dump, landfill or other.

Globally, the majority of waste is landfilled and the amount that gets recycled is just higher than that which is converted to energy, but there are significant variations in mix of disposal options by geography. In the U.S., 26 percent of all waste is recycled or repurposed, 9 percent is composted, 13 percent is converted to energy and 52 percent goes to landfill.[37] Lower-income countries tend to send higher amounts

**Figure 15**

Municipal Solid Waste Disposal by Income (millions tons)

Source: [43]

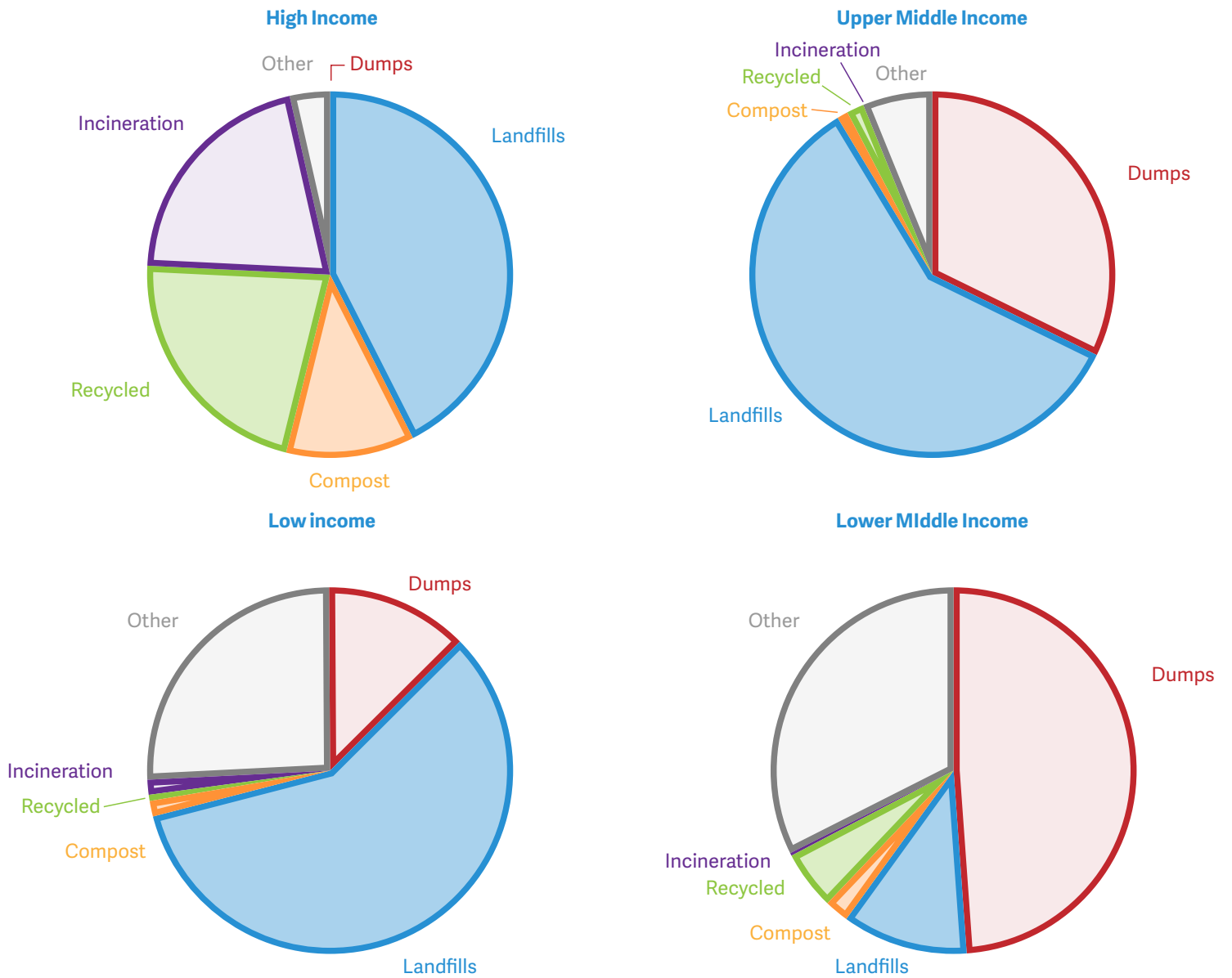

of waste to “other” – littering, backyard burning – where lower- and upper-middle-income countries are relying more on dumps. Almost all industrial-scale incineration takes place in high-income countries, though China is quickly adding capacity.

Of the 275 million tons of plastic waste generated each year, somewhere between 22 percent and 43 percent is collected and disposed of in landfills.<sup>[2]</sup> The U.S. recycles only 10 percent of plastic waste and most of the rest is landfilled, with 15 percent going to combustion, most often with energy recovery.<sup>[37]</sup> In Europe, 26 percent of plastic waste is recycled, 36 percent is combusted for energy generation, and 38 percent ends up in landfills.<sup>[30]</sup> The UNEP estimates that 57 percent of plastic in Africa, 40 percent in Asia, and 32 percent in Latin America is not collected.<sup>[2]</sup>

Post-Consumer Plastic Materials Management includes opportunities with innovations in collection, tracking and sorting, engaging and supporting the informal waste sector, enhancing recycling, repurposing and composting, potential WTE technology solutions, and supporting integrated waste management solutions. Each chapter highlights what is working and not working well today, recognizing environmental and economic risks of each, and points to opportunities for investment that could be prioritized.

## Key Concepts in Waste Management

Different tools and frameworks can be used to think about what does and should happen to waste. Here is a brief description of four that are particularly relevant for this work: hierarchy of waste, material flow analysis, circular economy, and zero waste.

### Hierarchy of Waste

The hierarchy of waste indicates the order in which different approaches to waste should be employed in order to maximize the value of the resources used and minimize environmental impact. Different organizations offer variations on this hierarchy that may highlight one concept or another, but they are generally consistent in their approach.

### Materials Flow Analysis

Materials flow analysis is the study of raw materials through the entire value chain to determine where the materials end up. This type of analysis can be used to inform life cycle assessments that measure the total impact of a product or process from start to finish. From a waste management perspective, materials flow

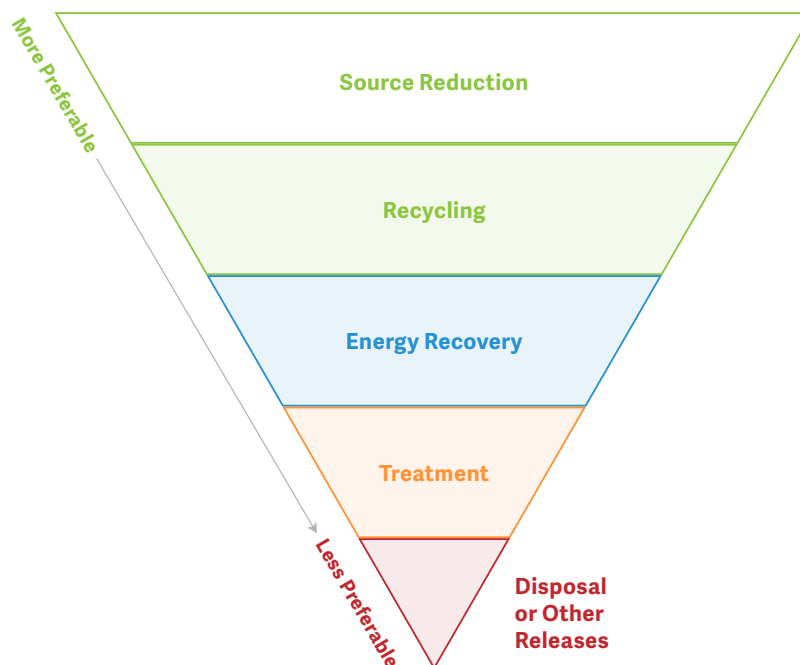

**Figure 16**

US EPA Waste Hierarchy

Source: <sup>[45]</sup>



**Figure 17**

Material Flow Analysis of Polyethylene Terephthalate in the US, 1996-2007

Source: [46]

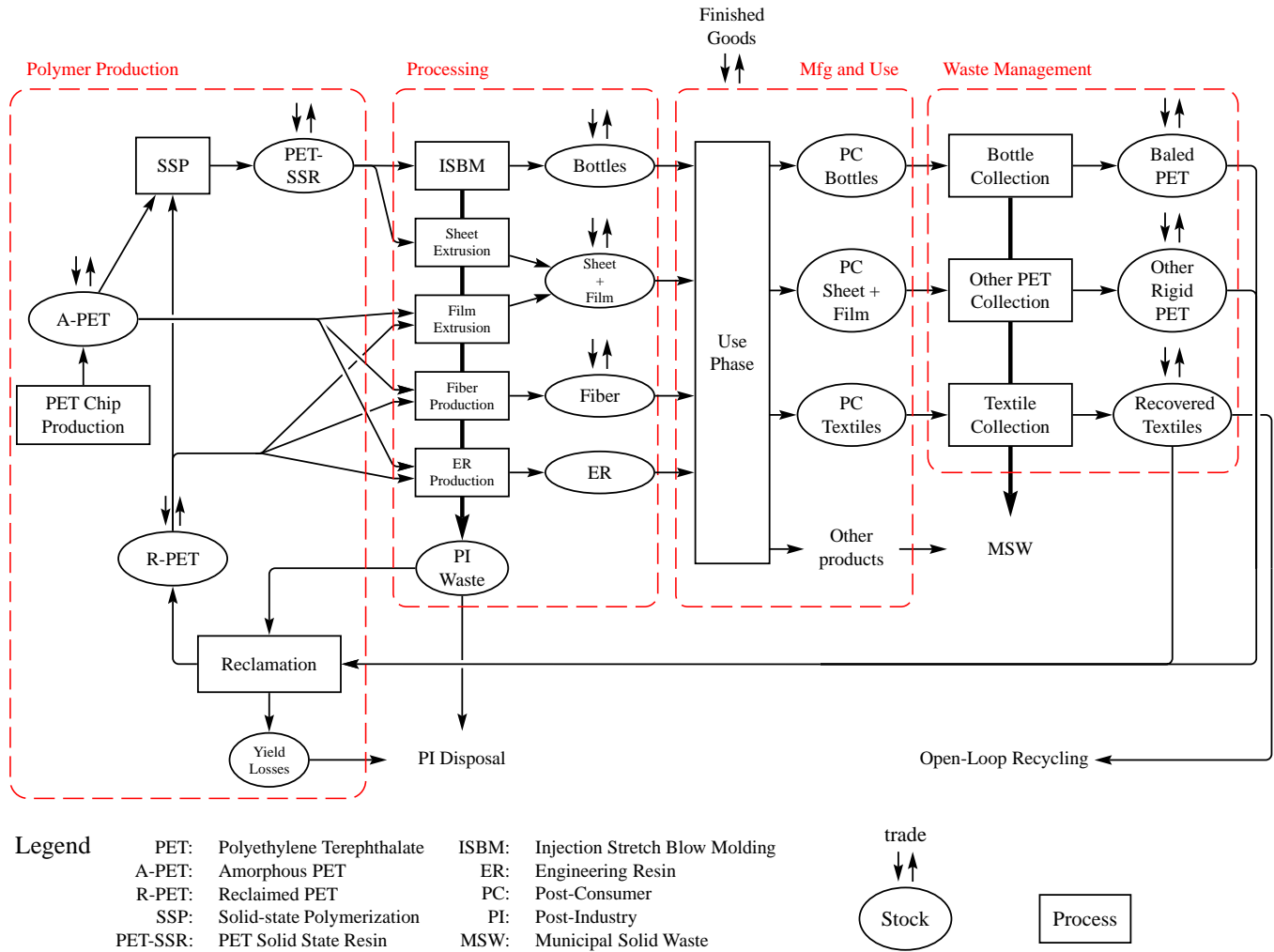

analysis can be a helpful tool in identifying the best places and ways to recapture certain materials at end of life. Figure 23 is a sample Materials Flow Analysis of polyethylene terephthalate in the U.S. during the time period 1996-2007. The PET material flow system was examined as an ideal case study of polymer recycling since it was the most recycled polymer in the U.S. Conclusions from this MFA were that while polymer recycling appears to be viable, it was hampered by low collection rates and a lack of reclamation infrastructure.

## Circular Economy

The Ellen MacArthur Foundation defines the circular economy as “one that is restorative and regenerative by design, and which aims to keep products, components and materials at their highest utility and value at all times, distinguishing between technical and biological cycles.” They depict the circular economy using a series of loops to express the circulation hierarchy for each cycle.

## Zero Waste

Zero waste efforts aim to reduce, eventually to zero, the quantity of waste going to landfills, typically without the use of incineration or waste conversion to energy. Zero waste efforts focus on maximizing collection of reusable, recyclable, and compostable materials, while shifting cities away from products that are made to be wasted. The zero waste vision is that people and organizations would change their practices to

emulate sustainable natural cycles, where all discarded materials are designed to become resources for others to use, thereby eliminating all discharges to land, water or air that are a threat to planetary, human, animal or plant health.

Zero waste efforts to date have catalyzed innovative offtake agreements in corporate and industrial waste streams and have brought into practice the concept that all "waste" from one process should be used as

**Figure 18**

The Circular Economy: An Industrial System that is Restorative by Design

Source: [47]

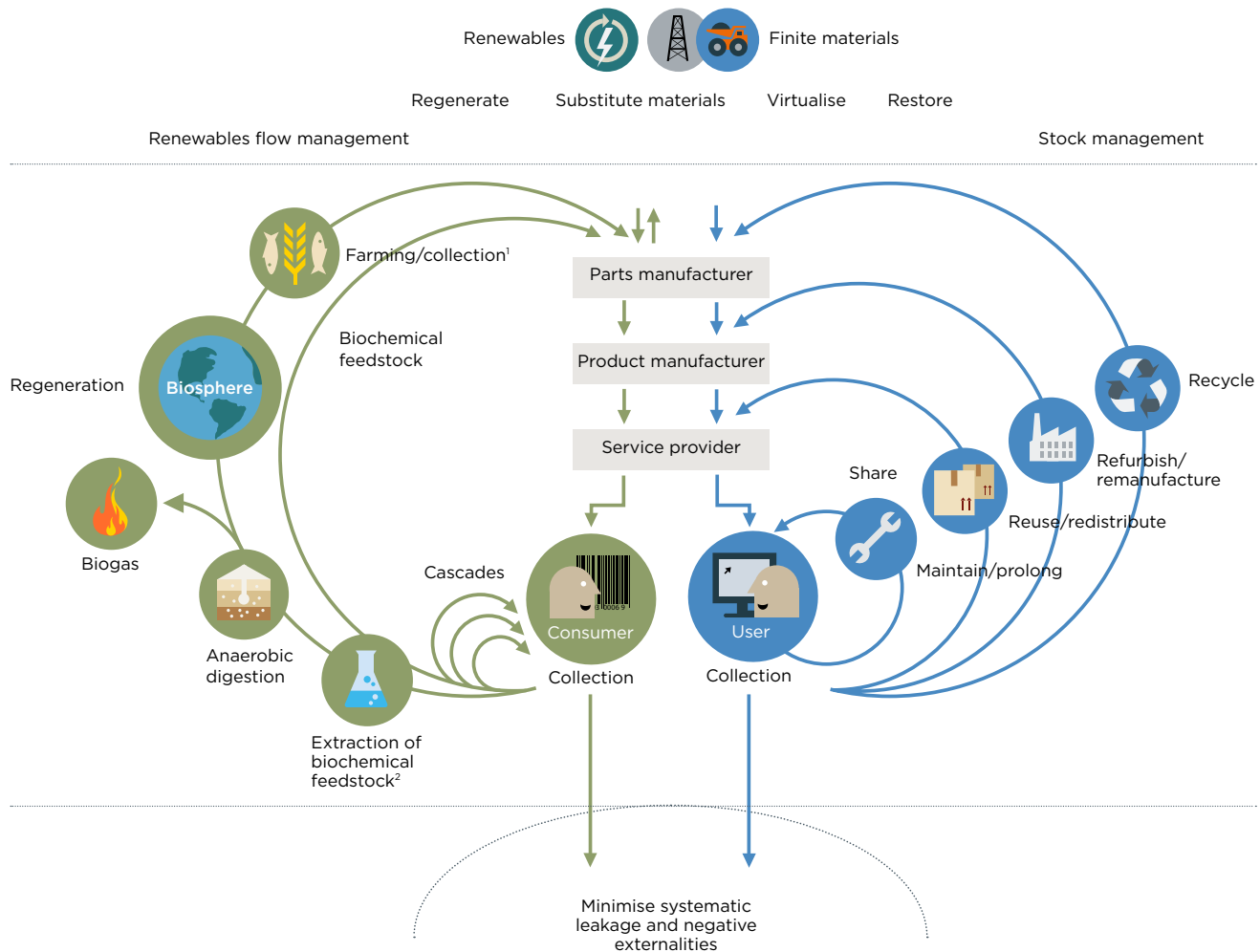

1. Hunting and fishing  
2. Can take both post-harvest and post-consumer waste as an input

SOURCE: Ellen MacArthur Foundation, SUN, and McKinsey Center for Business and Environment; Drawing from Braungart & McDonough, Cradle to Cradle (C2C).

**Figure 19**

A Zero Waste City

Source: [48]

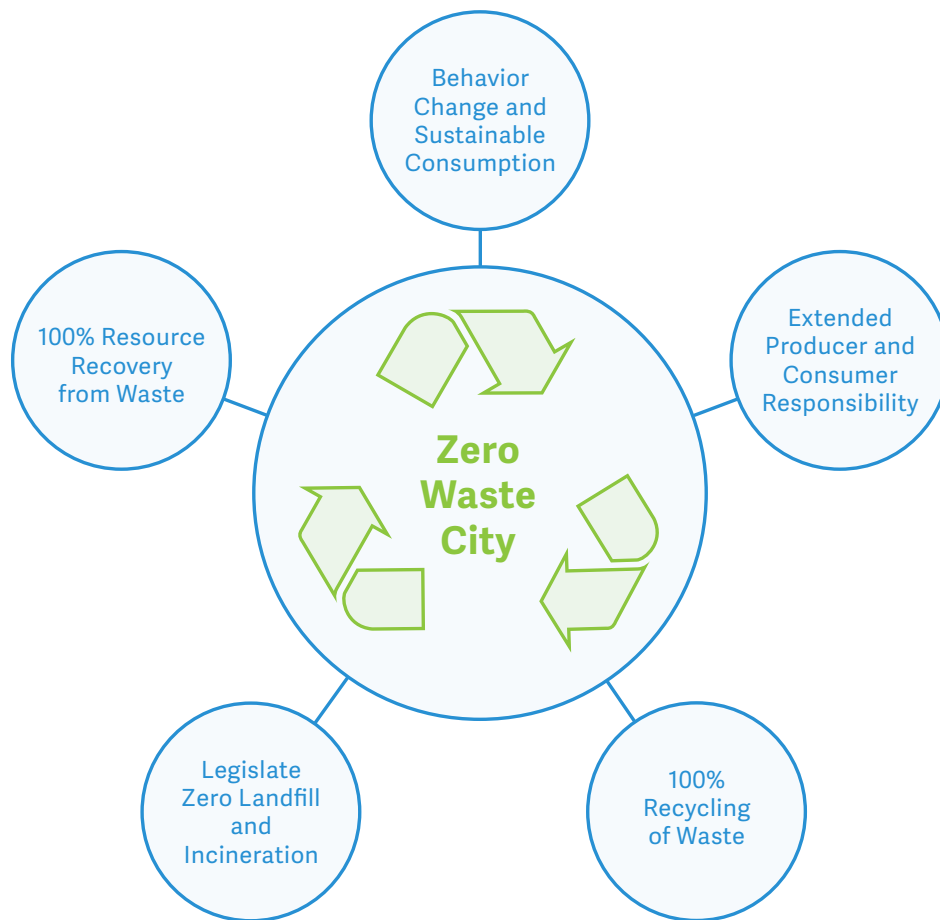

an input to another. Companies, cities and countries around the world are embracing zero waste principles and goals. For example, New York City has a goal of zero waste to landfill by 2030 and San Francisco is aiming for zero waste by 2020. Companies such as Walmart, Nike, Disney, Subaru, Nestle, Ford, and many others have set zero waste goals and some have achieved them (per their own definitions and reporting).

Global NGOs are also active in promoting and supporting zero waste efforts. The Global Alliance for Incinerator Alternatives (GAIA) has a network of affiliates worldwide that works on innovative zero

waste strategies in low- and middle-income countries with a focus on building the concept of zero waste into waste management infrastructure from the very beginning. These include networks and organizations like Zero Waste Europe, the U.S. Zero Waste Business Council, and member organizations in many countries. Proponents claim that the zero waste goal has prompted an increase in innovation, has reduced the amount of waste sent to landfills, and has led to significant increases in reusing, recycling, repurposing or otherwise redirecting waste, which is undeniably positive. Figure 25 is a visual representation of the zero waste concept for urban centers.[48]

## Zero Waste in the Philippines

Several municipalities in the Philippines are investing in comprehensive zero waste systems to improve existing waste management systems and reduce municipal costs. Transitioning to a zero waste system requires an up-front investment in new equipment, worker training, and community education over an 18-month to two-year period. Zero waste advocates say this capital can come from investors or philanthropy.

Mother Earth Foundation (MEF), a non-governmental organization in the Philippines, has been working to implement zero waste systems there, starting first in smaller communities and later expanding to cities. These zero waste systems separate collection with good recycling and organics management (through composting or biodigestion) to benefit from the value that would otherwise be “wasted” as well as from reduced transportation expenses. System successes can be further leveraged to reduce plastic pollution as cities start to see what is left in their residual waste—the waste they collect that cannot be recycled or composted. This can guide local policy to address the most problematic residuals—for example through bans on plastic bags, tariffs on certain kinds of packaging, and reduction of other problematic disposables, further influencing upstream strategies and driving adoption of alternative materials or distribution approaches.

Results from places that have implemented zero waste systems:

- **The City of Fort Bonifacio** in Taguig, with its population of 15,000, offers a prime example of success that can be achieved at small scale. City leaders established effective systems, built necessary infrastructure, created supportive policies, and inspired constituents to cooperate and 100 percent of households are now covered by door-to-door collection. Through effective community education and engagement, within the first six months of the project, 95 percent of

the residents were complying with the at-source separation of different types of materials. The waste diversion rate of the whole community is 92 percent; and the use of garbage trucks to collect and dump waste has dropped from four trips per day under the old waste collection model to one trip daily. Waste management has improved, and the village has created employment for local waste workers. Fort Bonifacio now regularly hosts eco-tours for stakeholders interested in replicating its successes.

- **The City of San Fernando** in Pampanga, with its population of over 306,000, has instituted a city-wide separate collection, recycling, and composting system, and has achieved high participation and a 73 percent diversion rate. San Fernando has quickly realized cost savings of almost 80 percent over its old “collect and dump” model of waste management.
- **In the City of Malabon**, MEF has worked in the low-income, industrial Barangay Potrero, with population 54,000, which was rife with illegal waste dumping, to establish MRFs and reach 89 percent compliance with 65 percent waste diversion in less than a year. Building on this success, MEF is currently pursuing scale-up resources for city-level work in Malabon (total population of 365,000+) and Navotas (total population of 250,000+), as well as for piloting significant neighborhood-scale work in three other nearby cities in Metro Manila. Project organizers say that an investment of \$400,000 over two years in this project would help to create systems covering a total population of over 1 million people, plus related policy and replication efforts. Upon completion, organizers expect that this effort would result in the reduction and management of approximately 250,000 tons of waste per year, an estimated 20 percent of which is plastic.

3

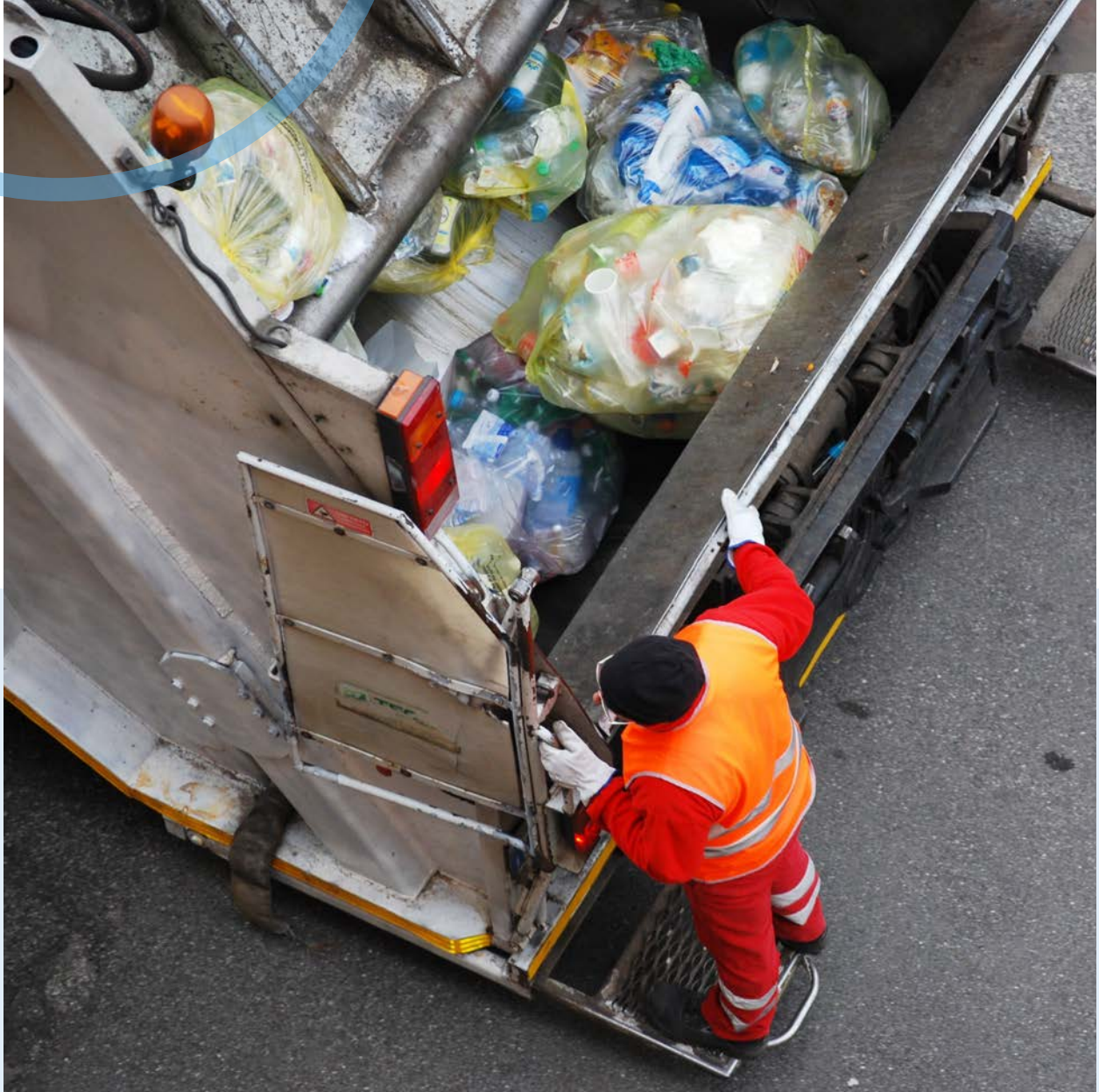





# Advance Collection, Tracking and Sorting Innovations

## Investment Focus #3: Advance Collection, Tracking and Sorting Innovations

**Accelerate the adoption at scale of next-generation collection, tracking and sorting technologies that can lead to greater recycling and circularity**

Collection is the key to diverting plastic waste from the ocean: waste that is collected has a dramatically higher likelihood of being recycled or properly disposed of than that which is not.

However, collection typically represents a net cost in the waste management process and must be paid for by citizens, businesses and/or government. For this reason, finding and scaling ways to reduce the cost of collection is essential to expanding collection services.

It is not surprising, therefore, that collection rates tend to correlate with a country’s income level, and there are regional trends as well (see Figure 26). In higher-income countries, there is an expectation of comprehensive waste management and the will and ability to pay for it. Additionally, regulations from anti-dumping laws tend to be enforced, giving people little alternative to the proper disposal of waste. Further, in some cases, policies such as Extended Producer Responsibility (EPR) ensure that there is a payer for waste collection.

Some countries face a range of challenges to increasing collection levels. These are explored in

more detail in the section entitled “Support Integrated Waste Management Solutions.” This chapter examines collection, tracking and sorting solutions through a global lens.

Innovations in the ways that waste is collected and tracked are taking advantage of advances in technology and experimenting with new approaches and incentives. Some of the innovations being piloted and scaled in countries with higher collection rates may be able to be transferred to lower-income countries to achieve a step change in the quality of collection. Other collection innovations are emerging in lower-income countries, developed by entrepreneurs living daily with the challenges that poor waste management creates. In both cases, investment is needed to support continued innovation and to scale successful solutions.

### Municipal or Private Waste Collection

When done well, municipal or private collection is very effective at ensuring waste is managed appropriately and does not end up in the environment or ocean.

For municipal collection in middle- and higher-income countries, citizens leave their bags or bins of garbage, and sometimes recycling, yard waste, and compost, on the curb and collection trucks typically operated by two people (a driver and a loader) come bin to bin to collect it from homes and businesses. Garbage trucks are designed to compact the waste along the way to



enable greater volume of collection between trips to unload.

In many lower-income countries, waste is collected house-to-house with hand carts or small trucks and aggregated at transfer stations around a city to accommodate their limited range. When municipalities cannot afford to pay for full collection services, private companies step in to serve the households and businesses that can pay a fee but lower-income families can be left with few options, which increases the risk of illegal dumping or burning. In some cities, the informal waste sector has taken over part or all of the collection service for neighborhoods.<sup>[49]</sup>

Given that the burden of collection is greatest on low-income residents of low and middle-income countries

that most often resort to dumping, identifying innovations in the waste collection industry may be key to reducing the flow of plastic into the ocean.

Collection programs anywhere may require citizens to separate recyclables or organics from other waste prior to collection. This is known as “source separation.” In many countries, source separation takes place at a very high level. In Germany and Japan, for example, there may be 10 or more individual bins to separate paper from plastic and food from metals. Other programs allow recyclables to be collected together in a single-stream recycling bin and sorted later. Finally, many observers in the waste management space argue for wet vs. dry segregation of waste streams, regardless of recyclability. When done well, any of these source-separation schemes can improve the quality of the

**Figure 20**

Waste Collection Rates by Income and Region

Source: <sup>[43]</sup>

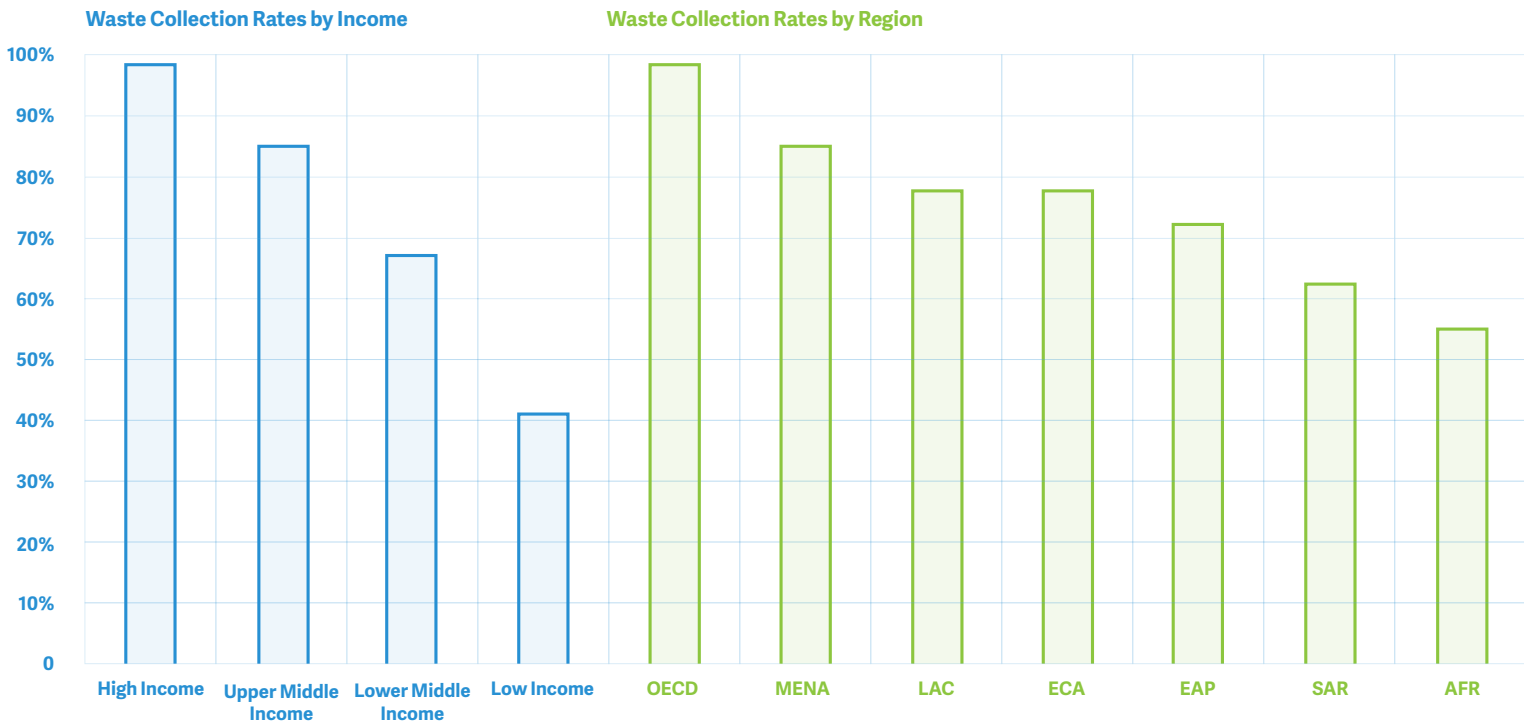

**OECD:** Organization for Economic Co-operation and Development  
**ECA:** Eastern and Central Asia  
**AFR:** Africa Region

**MENA:** Middle East and North Africa region  
**EAP:** East Asia and Pacific region

**LCR:** Latin America and the Caribbean  
**SAR:** South Asia region

waste stream. In non-segregated waste streams, the waste must be sorted after collection, which adds cost and ends up lowering recycling and composting rates. Education is vital for any of the source separation strategies to work. If citizens are not educated about how to properly clean and sort recyclables, it can lead to high levels of contamination in source-separated waste streams. (Citizen engagement programs are covered in “Additional Levers.”)

## Innovations in Municipal or Private Waste Collection

Innovations in municipal or private waste collection Technology and newly available and abundant data are spurring innovation in waste collection and helping to increase efficiency, decrease costs, and minimize greenhouse gas emissions, while new insight into behavior theory is informing novel approaches to increase recycling rates. While these innovations are primarily operating in higher-income countries today, there may be potential over time to apply these new models and technologies to increase collection and recycling rates in lower- and upper-middle-income countries.

When considering the adoption of an innovative technology, it is important to consider the relative costs, benefits and risks against the alternatives and make an informed decision. Newer and flashier are not always better, and different locales have different costs of labor and other inputs, making their cost/benefit equation very different from each other. This report presents these innovations as examples of how technology can help improve waste management; implementation of specific solutions must always be designed to fit the specific place and situation.

One source of new efficiency is the adaptation of intelligent routing tools, such as those pioneered by package delivery companies, to collection routing. These smart routing systems increase efficiency and minimize costs by identifying the shortest routes, minimizing left turns, and avoiding traffic. This option would work best in a large city with wide roads and is

not as applicable for door-to-door collectors who rely on carts and small trucks.

Collection and analysis of data from GPS and routing software, smart trucks and bin sensors are allowing more dynamic routing and just-in-time collection as well as enabling more efficient usage of garbage truck capacity. One startup has combined smart routing with in-bin sensors for commercial and industrial customers to enable dynamic routing that only picks up bins when needed, claiming to save haulers up to 40 percent compared to a regular pick-up schedule.[\[50\]](#)

RFID technology, combined with trucks that weigh the waste as they collect it, is being used in residential collection to better track household-level waste and recycling and could someday be shared back to customers in a way that allows them to compare themselves to their neighbors, the way Opower has done to successfully encourage reductions in household energy usage.[\[51\]](#)

Truck technology is also improving. Some communities use alternative fuel vehicles such as those that run on Compressed Natural Gas (CNG) which has the benefit of reducing direct carbon emissions. There are also trucks that use automatic side-arm loading technology and are designed to have only one operator, which can nearly halve labor expenses, cutting the overall cost of ongoing collection significantly.

Taiwan has turned garbage collection into a community event with singing garbage trucks. Twice a week, on a set schedule, garbage trucks roll through the streets playing familiar classical music tunes such as Beethoven’s “Für Elise”: this is the signal for residents to carry their bagged trash and recyclables out and deposit them in the truck. Taiwan adopted this system to address the pest, odor and sanitation challenges created by designated trash aggregation areas.[\[52\]](#)

Another technology that engages people in new ways is “eco-feedback” technology, which uses simple mechanisms (green and red LED lights, for example) to provide direct feedback on individual or group behaviors with a goal of reducing environmental

impact.<sup>[53]</sup> One study showed that this low-energy, low-cost technology resulted in statistically significant increases in recycling activity outside the home using a prototype of an interactive recycling bin that provided positive visual and audio feedback to users.

<sup>[54]</sup> In another example, Coca Cola created a temporary installation of a video game in the street in Bangladesh where the cost to play was an empty Coke bottle. They did not report collection rates but the videos of it show that people found it quite engaging.

These kinds of incentives for recycling are sometimes referred to as the “gamification” of recycling/collection. Gamification, often leveraging social media, has shown potential to increase citizen recycling rates. One company, RecycleBank, awards users points for taking online and offline actions to improve their recycling rates, as verified in partnership with waste haulers (recycling points are awarded at the community level). These points can then be redeemed for products or they can be donated to schools. Some external motivation and intermittent feedback can help develop habits that remain even when the feedback is taken away.<sup>[55]</sup>

Innovations and interventions do not have to be highly technical or expensive to be effective. In Kenya, Taka Taka Solutions provides waste collection services that are designed to be affordable to low- and middle-income families. One way they are able to do this is by recycling, reusing or composting 93 percent of what they collect – 60 percent is composted, 33 percent is recycled and 7 percent is residual. In 2015, Taka Taka was serving 8,000 households and handling over 10 tons of waste every day. Taka Taka’s 80 employees are predominantly women and they are paid fairly, provided with health insurance, savings programs, and a food program.<sup>[56]</sup>

## Alternatives and Supplements to Municipal Waste Collection

Collection is far from universal today. Even in high-income countries with strong formal collection, rural

and unincorporated areas may not have a municipality to provide the service, and those that do often find door-to-door collection economically unfeasible due to lower population density. In some cases, household waste pick-up is available but household recycling pick-up is not, and citizens must take their recycling to a drop-off point if they would like to recycle it.

### **Citizen Drop-off or Return**

Citizen drop-off centers receive waste and/or recyclables brought to them by citizens. Drop-off centers may charge by quantity (e.g., per bag) or may be funded by the municipality and be free with local identification. These drop-off centers are common in the U.S. in rural areas where household waste pick-up is often not available. Citizen drop-off centers can be located at grocery stores or other commonly visited sites for convenience.

Where deposits are required, as on PET beverage bottles in places like Norway, Canada, Australia and some U.S. states, there are reverse vending machines (RVMs) that pay people to deposit waste for recycling. These RVMs can often be found in grocery stores and other locations where bottles can be returned to get the deposit back. The RVM reads the barcode of the container, logs it for tracking purposes, and then returns the deposit to the consumer. RVMs allow materials to be aggregated and ensures a clean material stream. Instituting deposits on PET beverage bottles can lead to a higher rate (60-75 percent) of the containers being recaptured.<sup>[57]</sup>

In Indonesia, the Bank Sampah or “waste banks” pay residents to bring them segregated wet (organic) and dry (non-organic) waste. They compost the wet and recycle, repurpose or dispose of the dry as appropriate. Residents maintain an account with the waste bank and can make withdrawals as needed.

Another example of a citizen drop-off center is a punto limpio in Chile where it is free for citizens to bring their waste. It is then separated into a large number of precise categories to provide higher quality and cleaner materials for recycling.

While drop-off centers and reverse vending machines provide a solution for waste disposal and recycling in the absence of door-to-door waste collection, it has been found that participation in drop-off collection programs can be lower.[\[58\]](#)

### ***On-Demand Recycling***

A new paradigm for recycling that can cut down on costs for the recycling company is to offer on-demand recycling. In this set up, a customer only calls the recycling company when they have a sufficient amount of recycling to pick up, cutting down on unnecessary trips for the company. At least one of these companies, Toter in Hyderabad, India, even pays households for their waste, entirely flipping the equation of recycling collection.

### ***Shipping to Processors***

A newer form of materials collection expands what can be collected and recycled, while leaving the mechanics of collection up to the logistical expertise of package delivery companies. Pre-paid mailing containers are shipped to customers who load them with the specified materials and ship them back to the materials handling company.

While critiques of these technologies are that they will never scale, it is worth pointing out that they are relatively new and are targeting only niche applications. Additionally, they are all voluntarily funded by the companies producing the waste, similar to the mandatory model of EPR.

Terracycle's Zero Waste Boxes allow consumers to recycle "nearly every type of waste" found in an office or home, including hard-to-recycle materials.

Another company, Waste Management, offers a Recycle by Mail service that targets potentially hazardous items such as light bulbs, batteries, electronics, syringes and lancets, and also has options for common recyclables such as cans, bottles and paper. Customers pay online to order a specific box for the item they want to recycle and this payment includes the round-trip shipping and packaging costs.

Preserve also offers a mail-in recycling program for #5 plastics often used in yogurt containers that are not widely accepted by municipal recycling programs. (And RecycleBank users get points for using this service.)

All of these programs are at best niche applications today, but there is hope that with continued growth and scale, mail-in-recycling programs could make an impact on the amount of plastic waste in the ocean.

### ***On-the-Go and Event Collection***

Citizens also generate waste outside of their homes. Packaged food and beverage items, for example, lend themselves to being consumed outside the home, typically generating plastic waste and making waste collection options particularly important. Many municipalities provide publicly accessible trash and recycle bins on streets and in other public spaces and most businesses provide for collection of customer and employee waste on their premises. Waste is also generated at events like sporting events, concerts, and conferences. These events require collection of a large "pulse input" of waste.

On-the-Go and Event collection of waste poses a number of challenges: people are less likely to know what to do with their waste and recycling outside of their home environment and confusion can lead to mismanaged waste. Sometimes waste generation estimates for these events are too low and collection systems get quickly overwhelmed. The joyful atmosphere of many of these events can also result in an audience that is not motivated to manage waste properly.

The in-bin sensor technology used to optimize commercial waste collection described above is also being applied to On-the-Go outdoor public waste bins for just-in-time pick-up. This both avoids the issue of overflowing trash cans and also saves money by minimizing unnecessary pick-up trips.

The unique nature of "closed systems" such as stadiums, corporate campuses and conference centers presents an opportunity to use and capture

compostable products. Further, event spaces could be used for studies on how to best design these systems and motivate people so that event and on-the-go waste collection can be optimized.

### **Sorting at Materials Recovery Facilities**

Materials Recovery Facilities (“MRFs”) sort collected waste streams and direct each segregated waste stream to its appropriate destination – recycling processors, composters, conversion facilities or landfills.

Like collection, MRFs are an essential component of an optimized integrated waste management system but they are not always profitable on their own. While some MRFs are capable of covering their costs by monetizing the various waste streams, the economics are tight, especially when the prices of recyclable commodities are low.

MRFs can either be categorized as “clean” or “dirty” depending on whether they take pre-segregated waste streams or mixed waste streams, respectively, though there are different ways of segregating waste. In the U.S., “clean” MRFs refer to dual-stream facilities that take commingled containers and mixed fibers in separate streams. About half of all MRFs in the U.S. are dual-stream. Another third of U.S. MRFs are single stream, taking the same materials as dual stream but all in one stream. About 5 percent of MRFs in the U.S. are “dirty” where recyclables are commingled with waste, and the rest do not fit neatly into one of these categories.<sup>[59]</sup> In general, the more recyclables are mixed with other waste streams there is more opportunity for contamination of the recycled materials, leading to higher processing costs and/or less valuable recycled materials as a commodity product.<sup>[60]</sup> In many other countries, “clean” MRFs refer to dry or non-organic waste only.

One way to increase the inherent value of the waste is to require household separation, either between recyclables and non-recyclables or between wet (organic) and dry (non-organic) waste. However, in

countries that already have an established waste management system that does not segregate waste, the transition would be expensive and energy has instead been focused on improving sorting capabilities, with some MRFs claiming individual commodity recovery rates of 90 percent and waste diversion rates of 72 percent.<sup>[61]</sup> Of course, not all MRFs are this effective, but for countries still building their waste management infrastructure, setting up source separation and the supporting infrastructure from the beginning should enable greater efficiency for MRFs over time.

The size of MRFs can vary greatly. In the U.S., the average MRF handles 50-300 tons per day (up to 75,000 tons per year) but those in urban centers may handle volumes between 90,000 and 160,000 tons per year <sup>[59, 62, 63]</sup>. In India, the wasteworker cooperative SWaCH operates facilities that are akin to MRFs but accommodate only neighborhood-level waste streams (5-20 tons per day). Waste to Worth (W2W) in the Philippines is considering building MRFs that accommodate 250 tons per day. The size of the MRF is dependent on how much waste the operator expects to source and what the operator plans to do with the waste once it is sorted. For example, in the W2W model, the remaining waste will then be dried out and sent to a gasifier. In the SWaCH system, the organics are sorted out for composting and the remainder is landfilled. These different end destinations require vastly different scales of waste, leading to dissimilarity even at the MRF level.

Where labor costs are low, MRFs tend to rely on laborers to hand-sort waste in facilities that are similar to open warehouses with conveyor belts. Where labor costs are higher, MRFs use technologies such as bag breakers, magnets, and eddy currents to sort, filter, and segregate waste, but human intervention and sorting still often play an important role. Either kind of MRF system, as long as it is appropriate to its specific circumstances and requirements, can be a cost-effective component of an integrated waste management system.

## Catching Microfibers in the Wash

On a micro-scale, there is another “collection” innovation that has particular relevance for ocean plastics: microfiber capture in washing machines. Microfibers that have been shed from apparel items are a source of microplastic pollution in the ocean. Synthetic fabrics such as polyester may shed microfibers at any time, such as while people are wearing them in and around the ocean. However, the wash cycle has been identified as both a moment when fibers are more readily shed – and, as the Rozalia Project believes – more readily collected. This is especially important as wastewater treatment facilities do not clean all microplastics out of the water before they discharge it back into the environment. The Rozalia Project has designed and is bringing a microfiber catcher device to market to address this issue. The device is able to capture microfibers in the washing machine prior to the rinse cycle and prevent them from washing into the sea.

In some countries, waste pickers may be allowed to work on-site at MRFs extracting recyclables. These waste pickers are not employed by the MRF but rather work independently and get paid by selling the items they collect to recyclers, junk shops or other brokers. The MRF operator benefits from the ‘free’ sorting service they provide and is still able to earn revenue from the remaining waste streams. In some cases, however, waste pickers are not welcomed at MRFs and operators go to great lengths to keep them out. Where pickers are allowed or encouraged, there are ways of increasing participation from waste pickers in sorting out high-value waste, though without changed incentives they are unlikely to pick out low-value plastic waste, which is the likeliest to end up in the ocean.

### Innovation in Sorting

For clean or dirty mechanized MRFs, many promising new technologies are emerging that could significantly increase the effectiveness of sorting and, as a result, the amount of value captured from the waste stream. These technologies, which include RFID tracking of waste, optical sorting, image recognition technology and marker technologies, can lead to purer and therefore higher value waste streams entering the next phase of the waste value chain. Investments in these technologies could increase the profitability of MRFs, making sorting worth the cost and providing an economically viable alternative to simply landfilling everything.

## Investment Approaches for Collection and Sorting

Investment opportunities in next-generation collection, tracking and sorting are primarily in middle and high-income countries where collection is already established and well-funded. Opportunities in this space range from venture investments in start-up companies through investments in larger, more established firms.

### Collection and Tracking

- **Early and later-stage startups:** A host of startups are applying new technologies and intensive data analytics to the collection and tracking processes to drive cost savings and improve performance. These companies would be appropriate for venture-style funding.
- The implementation of the EPR laws for plastic packaging in the EU and Norway has spurred the development of several **companies to provide the waste tracking and collection services required by law**. These companies, like Infinitum, are often vertically integrated and handle the processing of the recyclable waste as well.
- Several startups are providing **new ways to collect recyclables**, such as reverse vending machines, gamification models, and recycling on demand. Despite these innovations, there is a somewhat limited amount of entrepreneurial activity in this



narrow space. Companies that are working on these models include Toter, Plastic Bank, Recycle Bank, and Taka Taka.

-“Investment Opportunities to Drive Use of Recycled Materials” provides investment notes on Processors, some of whom offer direct-from-consumer shipping options.

- Potential for investment exists in the area of **reverse logistics** as new solutions are found to better leverage backhaul on both consumer and commercial delivery services. This is a space to watch for the future.
- **Large international waste management companies** do research and development focused on collection technology, either in-house or with key partners, and they are also potential customers for the start-ups described above. These companies tend to be public companies.
- In countries with a robust informal waste system, it is possible to **empower waste pickers** to sort even more trash and divert it from landfills. These tend to be waste-worker cooperatives or zero waste groups, each of which could take on loans to finance their work. Cooperatives like SWaCH are working on this type of model.

-More in depth analysis is offered in the section "Engage and Support the Informal Sector" on page 89

## Sorting

Many **companies provide enhanced technology solutions for sorting**, such as optical sorting, multifunctional auto-sorting and even robotic sorting. There are startups innovating new solutions to sorting waste that would be potentially interesting targets for venture funding. In addition, a handful of large international firms are providing established and cutting edge solutions that might consider project equity or debt financing.

- For labor-intensive MRFs, **even basic sorting equipment still requires investment** that could benefit from private financing. Waste worker cooperatives, for example, could use micro-loans to grow their operations. In municipalities where the government controls the formal collection system,

the sorting could be privately financed to expand access.

There are few to no opportunities for investment in advanced collection technologies in lower-income countries because funding even the most basic collection is a challenge. While many of these advancements do bring down costs through efficiency or automation, they are still well above what can be afforded in these countries. As the lower-income countries develop, however, there will be opportunities to adapt and deploy these technologies.

## Considerations

- Waste management in general is a low-margin business that has struggled to support and scale innovation historically. Innovations that can drive down costs or increase revenues in addition to improving collection and sorting will have the greatest chances of success.
- Given that leakage rates are quite low in the countries where these technologies are being deployed, their direct impact on slowing the flow of plastics into the ocean is low unless they are specifically focused in geographies with higher rates of littering or other leakage. For this strategy to have a bigger impact on ocean plastics, the hope would be that some of these technologies would eventually become cheap enough or inspire cheaper alternatives that could be deployed in countries with higher rates of leakage.



4



---

**Photo Credit:** Plastics for Change - Bangalore Program



# Engage and Support the Informal Waste Sector

## Investment Focus #4: Engage and Support the Informal Waste Sector

**Provide equipment, opportunities and incentives for the informal waste sector in Southeast Asia and Africa (“waste pickers”) to enhance their collection of low and high-value plastic**

The World Bank estimated in 2008 that about 1 percent of the urban population in developing countries, or at least 15 million people worldwide, earns a living in the informal waste sector. About half of them are “waste pickers” [64] and the others work as itinerant waste buyers, in junk shops and second-hand markets, as dealers and as various kinds of recyclers. While it is called the “informal” sector, the activities are typically highly coordinated and well-organized.

In countries with inadequate waste infrastructure, waste pickers and the informal waste sector play a large role in the total amount of waste collected. Waste pickers may go door-to-door, or they may work the street, on trucks, in small and large open dumps, or even on-site at Materials Recovery Facilities.

Most informal waste pickers collect just enough waste to make enough money for that day and they focus their efforts almost exclusively on the highest-value waste – primarily metals and high-value plastics.

Metals are usually the most valuable parts of the waste stream and some waste pickers with magnets

target them for collection. Other waste pickers specialize in plastics, which have enough value to be worth collecting, though plastics’ low weight (and hence value) for its volume can make it difficult to carry enough to make it pay. PET is often the plastic of choice for informal waste pickers since it has the greatest resale value. HDPE and PP have less value, but are typically used in heavier, and therefore more valuable, products. Film plastics, wrappers, small items, plastic bags and other low-value plastics are not typically picked because they are not worth enough. As a result, low-value plastics are often the items that end up in the ocean.

Waste picking provides a way for people with very few options to make what is typically a subsistence living, though in some cases it can be more. In some cities, such as Brazil, waste pickers can earn up to four times more than the local minimum wage.[68] And waste picking is increasingly recognized as a critical source of entrepreneurial opportunities and economic empowerment for women, especially the disadvantaged and the poorest of the poor.

Nevertheless, waste pickers often work in unsanitary or even dangerous conditions. Waste may contain improperly managed hazardous items – heavy metals, chemicals, other toxins – as well as potentially pathogenic items such as medical waste, hygiene items and decomposing organic matter. They work in parts of dumps that have been burned or may still be burning to sift through ash. There are often animals scavenging

**Figure 21**

Informal Waste Management Sector

Figure compiled from: [65, 66, 67]

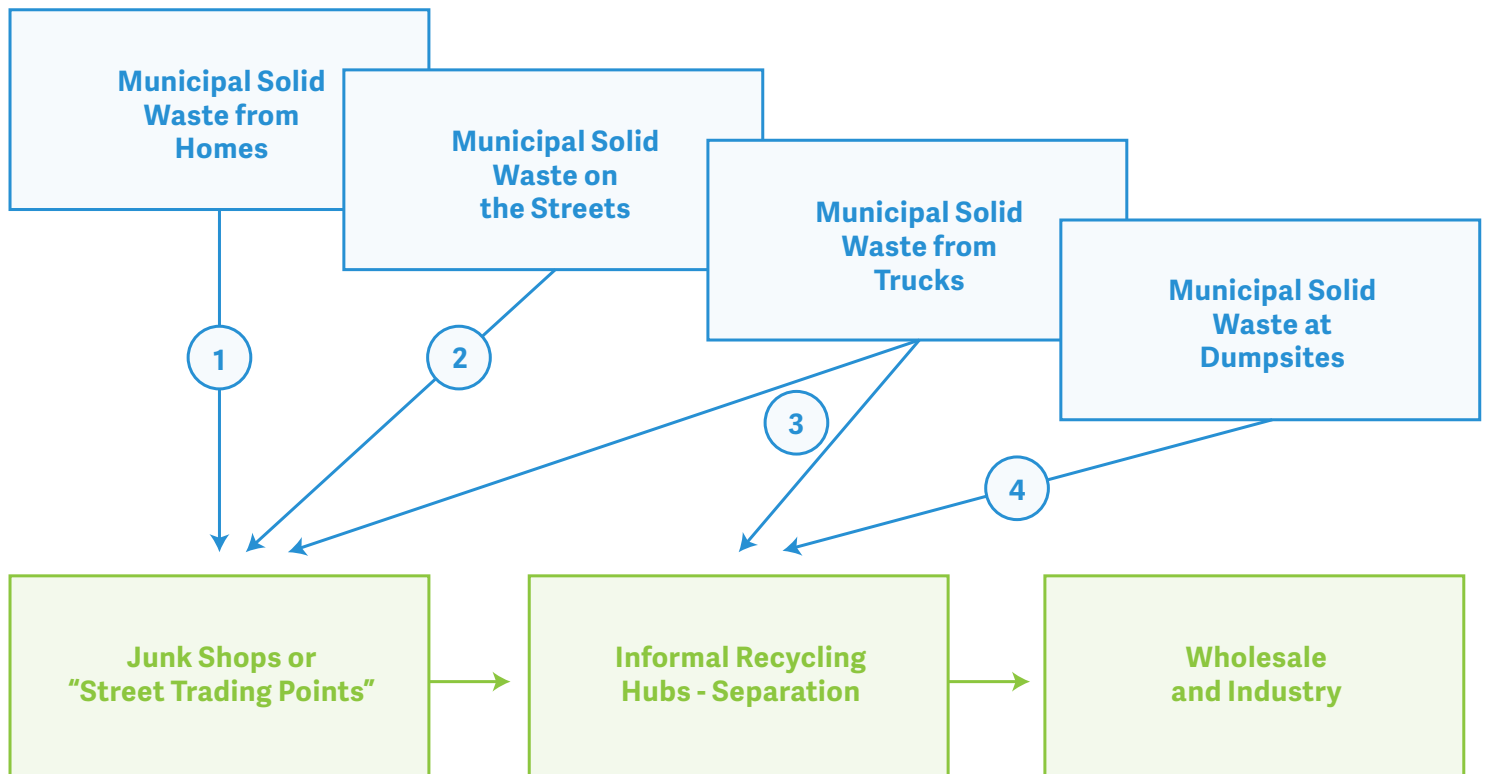

1

**Itinerant waste buyers (IWBs)** go door-to-door buying or bartering specific recyclable materials and/or organic wastes from households (individuals usually specialize in one or two materials). They may acquire and use a vehicle: 'three-wheelers' or tri-cycles are used in Bangkok, and wheelbarrows and push-carts are also common.

2

**Street waste pickers** collect mixed waste on streets or from communal bins before collection.

3

**Municipal waste collection crews** recover materials from vehicles transporting waste to disposal sites.

4

**Waste pickers/scavengers** sort through waste at dumps or landfills before it is covered for final disposal. These workers usually live in or near the dump.[65, 66, 67]

## Women's Empowerment Through Waste Entrepreneurship

Women make up a disproportionate share of global waste pickers [70] and as they are almost always the primary caregivers, this typically means their children are with them while they pick and often help by picking themselves. While for a long time this scene has stood as a symbol of extreme poverty, it is now being seen as one of economic opportunity and resourcefulness. There is an increasing recognition among the global development community that providing women waste pickers with training and micro-loans can provide a path to entrepreneurial success. For example, in the Philippines, the Payatas Environmental Development Programme targeted women waste pickers for its micro-enterprise development program in collaboration with Vincentian Missionaries Foundation. Together, the groups provided the women with micro-loans and waste-specific business consultancy and extension services. The program has been credited with launching a number of successful small and medium enterprises.[71]

alongside the people at these same locations. [69] Programs targeting the potential power of the informal waste sector in addressing ocean plastics must recognize these challenges and include plans to improve the working conditions for the workers they seek to engage.

### Recognition for informal waste sector workers

Attitudes towards waste picking and the informal waste sector are shifting. Whereas pickers were once vilified as social outcasts and compared to parasites, in some cities and countries they are now recognized as a valuable and important part of the waste management system. Waste management approaches in some lower-income countries are increasingly seeking to empower the informal waste sector to capture even more waste rather than discourage them. Waste pickers in some locales have even organized into waste picker cooperatives or unions with great success.

For example, in March 2013, Bogota's waste-pickers achieved recognition from the government, and they have been officially integrated into the city's formal waste management program. Now, each picker receives \$44 per ton from the government for recyclable solid waste delivered to scrap dealers, in addition to what they earn from the scrap dealers, who pay them per kilo. As a result, many waste-pickers have

seen their earnings double or triple. Bogota's waste pickers are now seen as role models for other members of the informal waste management sector around the world.

Curitiba, Brazil, is another city that registers waste pickers as part of an effort to improve working conditions and social acceptance for pickers. The EcoCitizen Cooperative currently has 600 members and 19 warehouses and handles 70 percent of the city's recyclables. It has received \$6.5 million in funds from the Brazil Development Bank to support its continued growth.

The World Bank has long supported the role of the informal waste sector in achieving better waste management outcomes in lower-income countries. In Argentina, for example, they helped waste picker collectives like CEOS SOL, El Ceibo, and Nuevo Rumbo gain legal status, offered training and education to their members, and provided adequate equipment. All of these interventions allowed the workers to collect more waste at a higher value.

Some companies have also recognized the value of the informal waste sector and have tried to leverage it for shared benefit. Danone, for instance, trained a group of about 20,000 waste pickers to pick a certain type of bottle specifically for a facility in Indonesia that turns bottles back into bottles. Additionally, they provide medical clinics to these workers to help support them.



Waste pickers are now generally believed to do a very thorough job extracting high-value plastics from the waste stream (for example, they are credited with reducing the amount of waste by one-third in Indonesia). However, for the reasons described above, low-value plastics are left behind, which leaves them at risk of washing into the ocean.

## Other Innovations in the Informal Waste Sector

Innovations in informal collection must have the dual goal of improving conditions and opportunities for waste pickers while also increasing the amount of plastic waste collected. A range of different groups is trying to harness the skills of waste pickers to keep more plastic from reaching the ocean, rivers or the environment while offering them services and support in return.

One company, Plastics for Change, is trying to improve conditions for waste pickers by making sales transactions between each of the actors in the system more fair and transparent. They have created the first open-book trading service that uses mobile technology to connect waste pickers, recyclers, traders and buyers in a fair process and helps ensure pickers are paid a fair rate.

Plastic Bank has coined the term “social plastic” to refer to plastic recovered by waste pickers. They began operations in Haiti with 16 collection kiosks where pickers drop off materials and receive local

currency or access to services such as mobile phone charging (each community is surveyed to see what offerings best serve the community’s needs). The collected plastic is shredded into flakes in Haiti and then shipped to processors designated by their end customers— companies such as Norton Point, a high-end sunglasses manufacturer. Plastic Bank plans to expand to Brazil, Indonesia and the Philippines next.

## Investment Approaches for the Informal Waste Sector

There are three priority opportunities for investment to support the informal waste sector, in addition to catalytic philanthropy, which is detailed in a later section. Many of the investments outlined here are not suitable for traditional investors, but with support from governments, DFIs, and philanthropists, many of these investments may make sense.

First, provide debt, either as low-rate microfinance or larger-scale traditional loans, to worker-owned cooperatives. These co-ops need start-up capital to purchase equipment such as hand-carts or motorized carts, which can then enable them to significantly increase their revenue, allowing them to pay back the loan and improve their quality of life in an enduring way.

Second, support companies such as Wongapanit in Thailand, a franchised junk dealer that works with the informal waste sector. These investments could be equity in the firm or a franchise location. Expanding the number of junk dealers provides more customers

## Informal Waste Sector Workers Going Door to Door in India

Solid Waste Collection and Handling (SWaCH), in Pune, is India’s first wholly-owned cooperative of self-employed waste pickers. Pune’s waste pickers are more than 90 percent women from the lowest caste in India, Dalit (or “untouchable”), and most are the sole breadwinners for their families. In 2008, SWaCH partnered with the Pune Municipal Corporation to conduct door-to-door garbage and recycling services for the city. This arrangement provides the workers with better working conditions (they are provided with protective gear, rolling bins and even some motorized carts or trucks) and they can make the same or more money in fewer hours, compared to other jobs, leaving them more time to care for their families.<sup>[72]</sup>

for the informal waste sector workers and may make it easier to access them.

Third, invest in companies working with the informal waste sector to scale recycling efforts. The Plastic Bank, Plastics for Change, and Bank Sampah, among other innovators, are working to expand waste infrastructure and capture larger portions of the plastic waste stream than traditional junk dealers. Encouraging their efforts may provide a low-cost solution to tackling the highest impact plastic waste.

Finally, this is an area where a Pay-for-Success model could work well as it would be relatively straightforward to create the metrics and track progress, would have a direct impact on reducing ocean plastics (if done in the appropriate geographies), and would have the added benefit of enhancing the livelihoods of informal waste sector workers as well.



## Pay for Success

Pay-for-success models are a way of implementing innovative projects at scale in which the risk of the project's success is transferred from the municipality, NGO, or other loan recipient to the investor. This is done by tying the repayment of the loan to the project's success – a more successful project pays more than an unsuccessful one, for example. Using this structure, entities that are considering innovative projects are freer to pursue them, knowing that the final repayment amount will be determined based on the project's success.

First used in 2012, the social impact bond has grown rapidly as a way of scaling innovative social interventions, such as early childhood education and prison rehabilitation programs. Environmental infrastructure has also been funded using this model, with Washington D.C.'s DC Water stormwater impact bond proving the concept.

For waste management, this model could be used to fund a number of innovative waste management strategies. For example, a municipality could issue an impact bond to fund the growth of a zero waste-based informal waste collection approach. These methods have the potential of saving a municipality greatly if they reduce the amount of waste generated, but require investments in training and infrastructure before being implemented. With funds from an impact bond, the municipality could pay for these upgrades, and repay the loan solely based on the program's ability to save money in the long run.

Figure 22

Pay for Performance

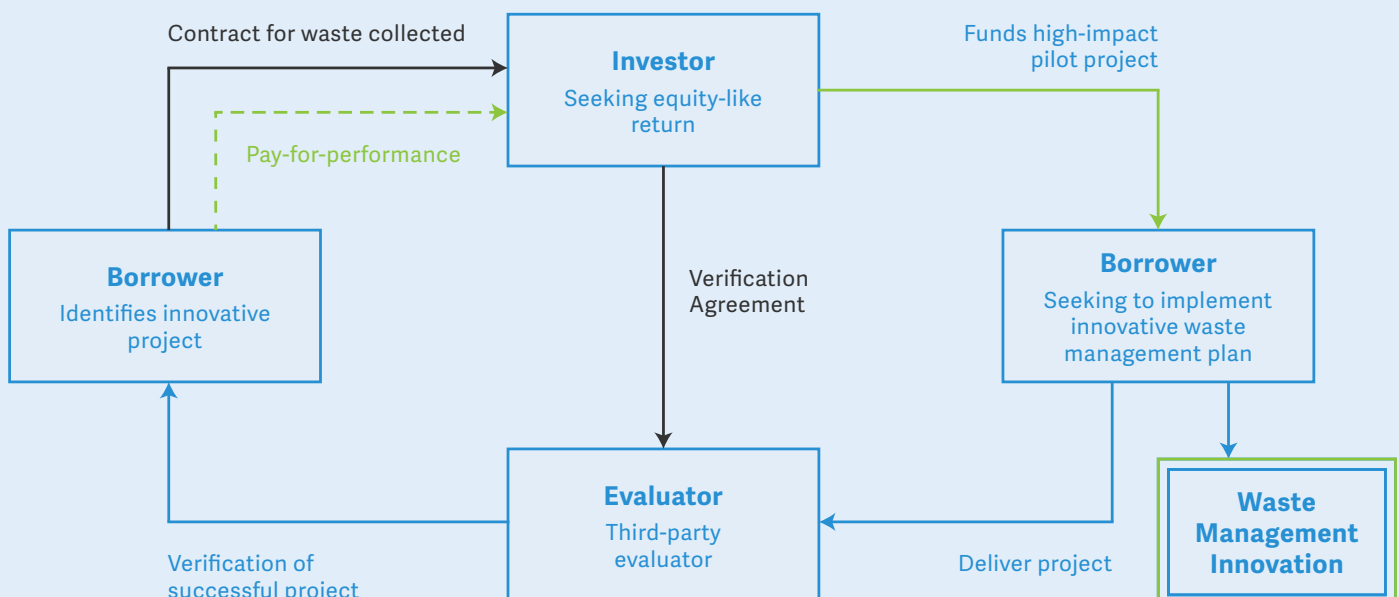





5

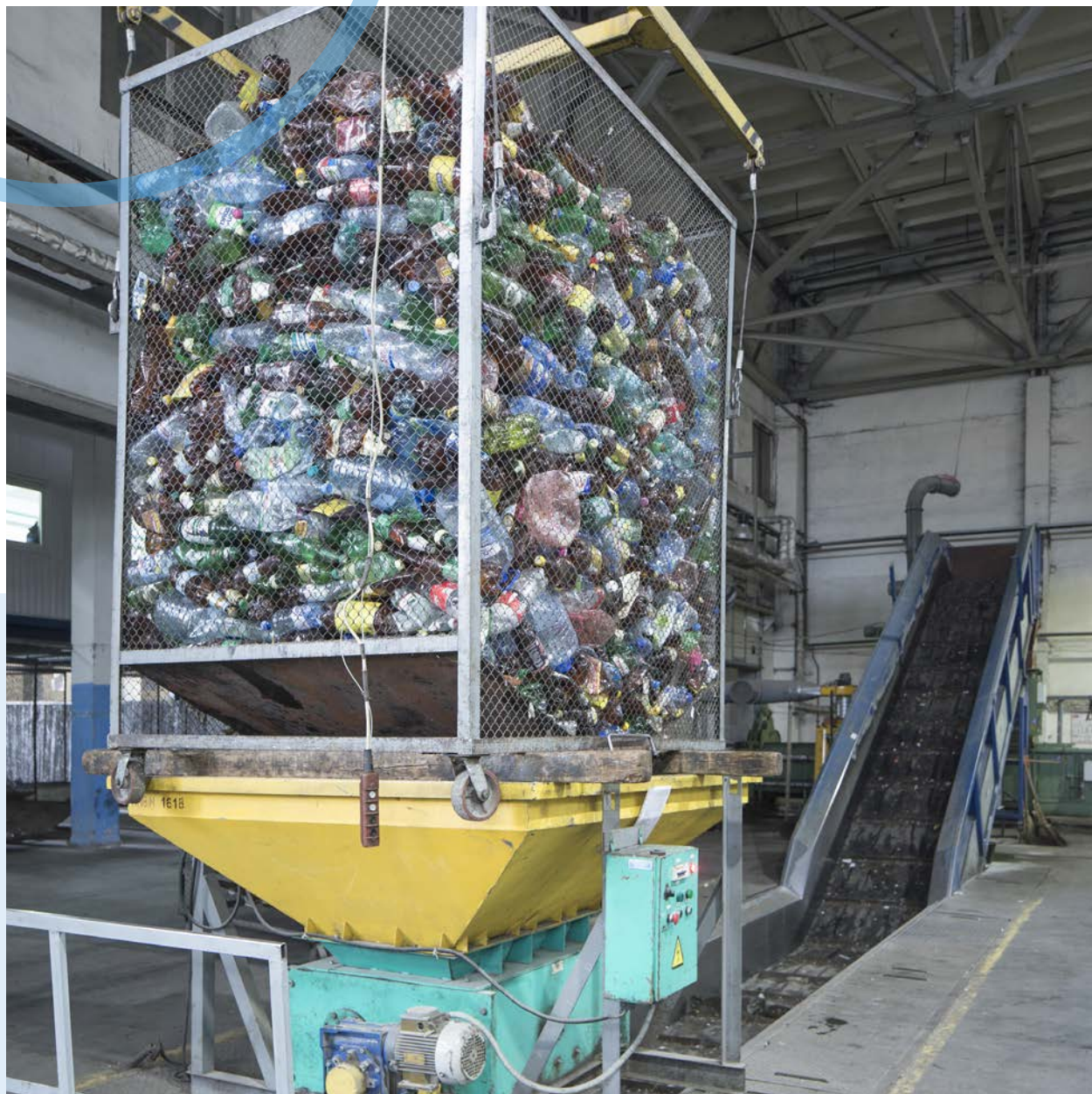



# Enhance Recycling, Repurposing and Composting

## Investment Focus #5: Enhance Recycling, Repurposing and Composting

**Support the development and scaling of materials and products that use reclaimed or recycled feedstock, creating pull in the system to better capture waste at each stage of the value chain (both circular loops, such as bottle-to-bottle recycling, as well as waste repurposing)**

Once waste has been collected and sorted, communities and companies work to extract the maximum value from it. There are three primary ways waste materials generate revenue: through recycling, composting or WTE . Currently, smaller quantities of plastic may be used as a resource in gasification, pyrolysis, or as a feedstock (as-is, without reprocessing) in the small-scale creation of construction materials, but these all typically happen in a more localized setting.

### The Global Plastic Recycling Industry

The system for recycled plastic recovered for re-manufacturing globally is shown in Figure 29. And it is global: the same plastic bottle, in its various forms, may be shipped to a different country for each stage of the process.

Manufacturing takes place in many countries around the world. China is the largest producer of plastic in the world (27.8 percent) followed by the North American

Free Trade Agreement (NAFTA) countries (18.5 percent), the EU (18.5 percent) and the rest of Asia (16.7 percent). [9] This plastic is then shipped to manufacturers around the world, with a large quantity of manufacturing occurring in China.[73]

When plastic is recycled, it is typically processed locally first at a materials recovery facility (MRF) where it is sorted and then it is either compacted into a bale or shredded, so the mass of plastic in a given volume is maximized. The densified plastic is then transported, sometimes over long distances, to a processor. One example of a processor that takes recycled plastic is Envision, in North Carolina. They accept recycled HDPE from Plastic Bank that is collected and shredded in Haiti.

The processor cleans the plastic and creates the form of plastic that is the raw material needed as the feedstock for manufacturing, plastic pellets. These pellets then can be shipped to manufacturers where they are typically combined with some amount of virgin material. For example, Infinitem in Norway uses approximately 6 percent virgin for PET bottle-to-bottle recycling , while BIONIC yarn states their FLX yarn is 100 percent recycled PET.[74]

PET is the most commonly recycled plastic and it can be made into fibers as well. For example, Parley for the Oceans facilitates the collection and baling of PET in the Maldives, then ships it to a processor and then a manufacturer for Adidas.[75]



**Figure 23**

Global Plastic Flows, Focusing on Recycling

Notes: 1. [9], 2. [1], 3. [37]

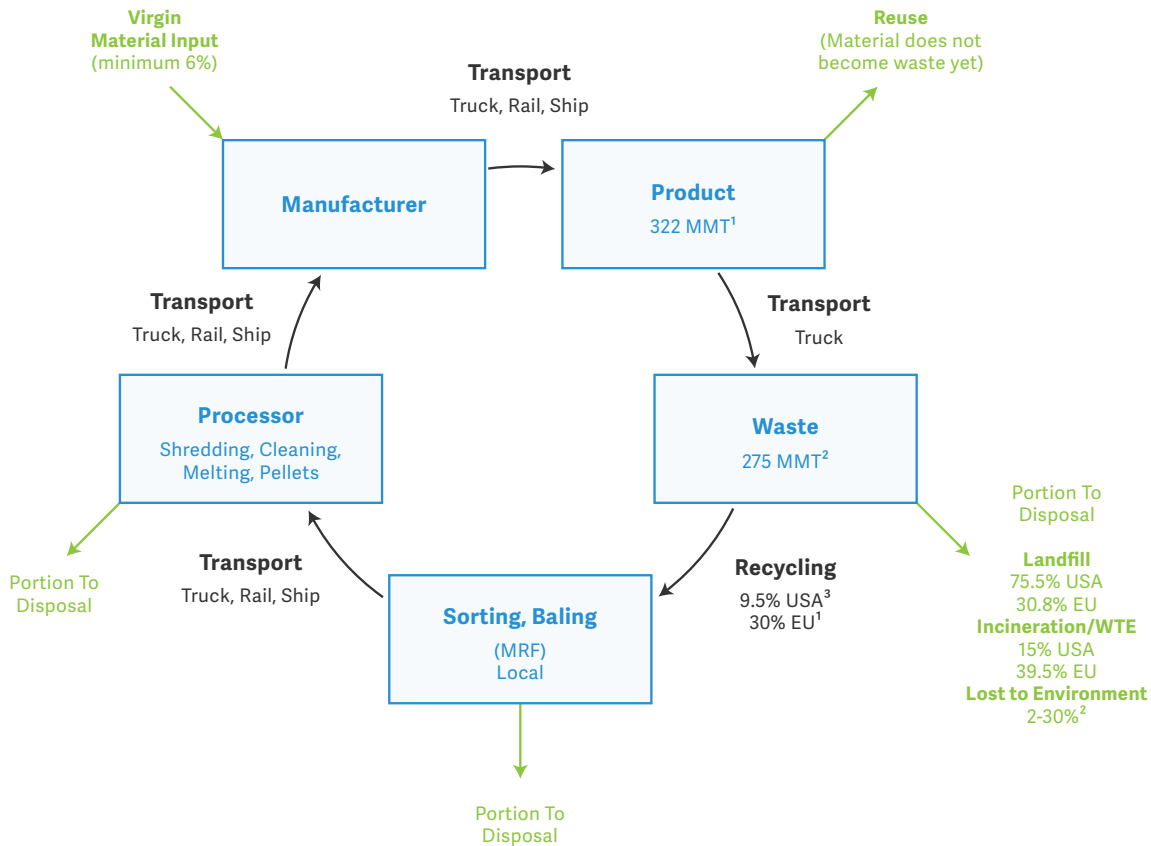

In some cases, the processor and manufacturer are co-located, but overall this is a highly globalized system with many logistical, political and economic interdependencies.

## Recycling

Recycling is critical to keeping plastic out of the ocean. Simply put: when post-consumer plastic is seen as having sufficient potential value, it will be captured for recycling. Without a robust recycling market, plastic that is collected for recycling today, especially by waste pickers, could, in the future, make its way to the ocean instead.

However, the recycling industry has struggled in recent years from challenges to its economics.

Low commodity prices have crushed the margins of recyclers and forced many out of business, as has the price gap between recycled and virgin material due to low oil prices. Further, the implementation of a “green fence” around China halted the sale of recyclable material that did not meet standards of the country and impacted global commodity recycling prices. In California alone, more than 800 recycling centers have shut down since February 2015 and, overall, nearly one-third of California’s recycling centers have gone out of business.[76] Once-profitable recycling operations within integrated waste management companies are now only being maintained due to contractual obligations, and some have sought to modify contracts ahead of their renewal dates to jettison the money-losing operations.[77]

In a further blow to the economics of recycling, recycling streams have seen increasing levels of contamination from single stream inputs and sorting challenges as well as from undisclosed inclusion of additives that impact the recyclability of what are otherwise identical materials. Further, biodegradable plastics like PLA can be visually indistinguishable from PET and can contaminate recycling streams. These disruptions to the recycling process add cost and can lower the value of the recycled feedstock produced.

## Strengthening the Recycling Industry

What is required to improve the economics of the recycling industry is a perfect example of how difficult it is to optimize a single step of the waste value chain independently from the others. While there are high-impact strategies that recyclers and processors can adopt, many of the highest impact actions fall either upstream or downstream of their sphere of influence, making it more difficult to affect those changes.

Upstream, recyclers must rely on materials engineers and manufacturers to improve the recyclability of materials, including the implications of additives and colorants, and on product designers and product manufacturers to enhance the recyclability of products and packaging through design. It is also important that waste management companies and the informal waste sector aggregate enough plastic waste of each type to make the process of recycling more economically efficient. Finally, achieving cleaner streams of recyclables falls to collection and sorting.

But a critical lever for improving the economics of the industry, and for generating enough pull to keep plastic

out of the ocean, is downstream, building demand for recycled feedstock and products. This report identifies five ways to stoke demand for recycled plastics, some of which can be advanced by recyclers independently, and others of which will require them to partner with others.

### **Innovate recycling processes and technologies**

The tough economics of the recycling industry can make it difficult to fund new facilities that take advantage of advances in technology, but some companies are still finding a way. By increasing the collection of recyclable material and aggregating the various materials in MRFs, companies that build infrastructure upstream from recycling can increase the scale and lower costs for recyclers.

Recycling financiers such as the Closed Loop Fund are partnering with recyclers to finance the construction of recycling facilities in the United States. MBA Polymers is focused on recycling the plastic from durable goods and plans to build Plastics Recovery Facilities (“PRFs”) where they will sort out the hardest to recycle plastic for their own use. Both of these companies are making the collection and sorting process more efficient and allowing for greater scale. This will in turn lower the costs of recycling, as the materials sorted at these facilities will be more easily recycled.

### **Recycle or repurpose plastic waste into higher-value products**

Items from backpacks to soccer jerseys are now being made with recycled PET bottles. These products are fighting against the low prices for recycled plastic by converting the material directly into high-value products. Some companies in this space make their

## Repurposing Waste for Social Impact

Repurposing or “upcycling” of plastic waste is also being used as a strategy to provide income opportunities for vulnerable populations in lower-income countries. For example, in Ghana the Recycle Not A Waste Initiative, “Recnowa,” trains street youth, people with disabilities and poor women from urban slums to use waste plastic to create unique, hand-crafted eco-friendly products which are then sold in international markets to provide higher wages than would be possible for them through other employment.[78] Similar programs exist in other African, Asian and Latin American countries.

return by marketing their recycled material toward socially and environmentally conscious consumers, while others try to compete at market prices. Companies in this space still need to be careful that their products do not end up being disposed of improperly and contribute to the ocean plastic problem.

Some start-ups have designed new products using this abundant feedstock, such as women's shoes from Vivobarefoot, and "Earth Bags," which are convertible duffel bags made from 100 percent recycled plastic bottles and lined with repurposed vinyl billboards, making each one unique. Other recycled plastics are also finding higher-value uses. Green Toys makes children's toys from recycled milk jugs and Preserve makes toothbrushes and razors from hard-to-recycle #5 plastics such as yogurt containers.

Larger companies are also seeing opportunities to use recycled feedstock in certain product lines. Nike is using recycled PET bottles to make soccer and other uniforms for professional athletes, currently using about 18 bottles per shirt, but these are not available

for purchase. Pilot's Bottle2Pen line of gel-roller pens uses 89 percent post-consumer plastic bottles and the ballpoint model uses 83 percent.

Terracycle is a company that works with producers of hard-to-recycle items to capture and recycle their products outside of traditional waste collection. By working directly with the producers of hard-to-recycle plastics, Terracycle receives funding for the upfront recycling costs and guarantees a buyer for its recycled material. This is, in effect, a blend of EPR with recycling and collection infrastructure.

Beyond consumer products, low-value, high-value and hard-to-recycle plastics are also being used to create building materials such as lumber and bricks, park benches, roofing shingles, and even roads.

### **Use more recycled content in packaging**

In the absence of larger policy mandates, voluntary commitments by companies to use larger amounts of recycled material in their packaging also have the potential to drive up demand for recycled material. This approach shows how recycling and material design can be linked in a circular economy.

## **Products Made from Reclaimed Ocean Plastic**

Several companies have gone all the way to making products or packaging out of plastic reclaimed from the ocean. Given that ocean plastics can accumulate toxins in the ocean, the use of reclaimed ocean plastic should be thoroughly evaluated for safety.

- **Adidas and Parley for the Oceans** created a running shoe made from plastic reclaimed from the ocean around the Maldives. The uppers for one shoe are made from 16.5 plastic bottles and 13 grams of plastic from recycled gill nets. The soles were 3D printed also using ocean plastic. Fifty pairs of the shoes were produced and will be given away through a contest.
- **Method** used a combination of reclaimed ocean plastic and post-consumer recycled plastic to create the bottles for its 2-in-one dish and hand soap. The mix of recycled plastics resulted in a uniquely gray resin. The packages were sold with a plastic hang-tag telling their story.
- **Italian firm Aquafil** is using reclaimed discarded nylon fishing nets as feedstock for carpeting. The ECONYL fabric takes advantage of the complete recyclability of nylon 6 and is also being used to make clothing including swimsuits.
- **Bureo** makes skateboards and sunglasses from fishing nets dropped off at their collection sites in coastal Chile.

While these products can be a useful tool for raising awareness of the problem, it is best to focus resources on keeping plastics out of the ocean in the first place rather than trying to reclaim and reuse them once they are there.

## Chemical Recycling, or Depolymerization

Depolymerization is a general term for turning polymers back into monomers. It can be done with heat and pressure or chemically, and the resulting monomers can then be sold to make polymers again. Loop Industries currently depolymerizes PET commercially and they are working on incorporating PE as well. Loop reports that they are able to conduct depolymerization without any energy input into the process. With facilities capable of processing 1,000 tons per day, there are some who believe that depolymerization is the cleanest conversion solution realistically capable of handling enough waste to make an impact on ocean-bound plastic. Others argue that the scale is actually prohibitive, as very few places generate enough waste daily to satisfy the quantity required by a depolymerization facility. High lock-in is also a concern with projects of this scale. Others doubt the effectiveness of the technology, as it has been implemented in Europe. Further research is needed to know the true impact and viability of this technology.

One example, Ice River Springs, has an in-house bottle-to-bottle recycling facility that takes harder-to-recycle colored plastics and uses them to make new green bottles from 100 percent recycled feedstock. A number of cosmetics companies, such as Aveda, LUSH and Mac, have made commitments to use more recycled content in their packaging and also to take back packaging in store that may not be accepted by curbside recycling programs. Some companies may choose to first look at capturing and reusing the pre-consumer waste in their own supply chains before expanding to post-consumer waste, which is a step in the right direction.

### Promote recycling for non-plastics as well

Supporting the recycling of other materials may indirectly support plastics recycling by bringing more value into the system and sharing the overhead of recycling collection, sorting and transportation. E-waste and medical waste are emerging as high-value recycling operations in spite of prevailing economic tides against recycling, thanks largely to the higher residual value of component parts and to policies requiring their safe disposal. These types of recycling have an impact above the sheer amount of material they recycle, as hazardous chemicals, metals, and biohazards are kept out of landfills and the ocean.

### Policy and other encouragement and incentives

Industry groups such as Sustainable Packaging Coalition and Sustainable Apparel Coalition provide

education and encouragement to member companies for use of recycled material in their products and packaging. The U.S. Green Building Council's LEED design certification gives extra points for the use of building materials, furniture and fixtures that have recycled content. Activist investors could demand greater transparency in use of recycled content to increase pressure on public companies. Policy interventions will also likely be needed to help create the conditions for a thriving marketplace for recycled feedstock. The "Government Actions" section provides an overview of how policy can promote use of recycled materials.

## Composting

Composting is another way to turn waste into value, and it has a particularly important role in transitioning to bio-benign alternative plastic materials. In this way, there is an important role for composting in both developing countries with a high percentage of organic waste and in countries that may wish to adopt bio-benign materials, keeping in mind that these distinctions are not mutually exclusive.

Composting matters for ocean plastics because it can help make the economics of the whole waste management system work better, which leads to less mismanaged waste and less plastic waste to the ocean. Additionally, many of the countries with the highest levels of mismanaged waste also have a higher

percentage of organic waste in their municipal waste streams, which suggests there could be an opportunity to develop this market.

When organics are separated from the rest of the stream and are well managed, the rest of the stream becomes drier. This makes it easier to work with and recycle, which makes the waste stream more valuable.

In certain markets, high-quality compost is seen as a very valuable product and some of the integrated waste management companies that offer composting have said that it is the most profitable part of their business. A challenge exists, however, in some Asian countries where there is a strongly held preference for chemical fertilizers rather than compost, which would need to be overcome.

Composting requires relatively little technology and it can be done at either a household or industrial level. Composting is the controlled degradation of biodegradable materials and is typically aerobic and done in open systems. If conducted without oxygen, it is anaerobic; odors and methane are then produced and must be managed.

Household organic matter, like non-meat food scraps and yard waste, can be composted in backyard heaps. In certain environments, zero waste groups advocate for this practice to become mainstream, as it reduces

the overall amount of garbage entering formal collection and being landfilled.

Composting conducted in industrial settings is different than citizen backyard composting. Industrial composters, in addition to being larger scale, typically enable the compost to reach higher temperatures, turn the material more often, and monitor it more closely. Industrial composting can breakdown PLA, paper products, used compostable diapers and meat scraps, in addition to everything that smaller composters take.

Composting is especially important as a complement to recommendations to shift toward using greater amounts of compostable or biodegradable plastic packaging such as PLA or PHB. In dumps or basic landfills, these products emit methane into the atmosphere as they biodegrade, a potential negative externality unless the gas is captured, oxidized or beneficially used for energy. Industrial composting in controlled environments, however, if aerobic, does not create methane emissions.

With bans on yard waste going into landfills in many states in the U.S., municipal composting facilities, at least for yard waste, are extremely common. Food waste composting facilities are less common, but there are a growing number in operation. San Francisco requires household-level and commercial collection of food scraps and yard debris (often called "green waste") for composting in an industrial scale operation

## Municipal Composting

In 2009, San Francisco became the first U.S. municipality to universally require organic material to be separated for composting. Residents are required to separate household organic waste for collection in biodegradable bags which get placed in green bins. This program is one of many programs that have been developed to help the state of California and the city of San Francisco meet ambitious goals on reducing greenhouse gas generation, as well as to help achieve San Francisco's goal of zero waste by 2020. As of 2011, San Francisco was composting about 600 tons of organic material every day.<sup>[79]</sup> The end product is sold to area farmers and vineyards and is reported to be a profitable line of business for the waste management companies running it. Even though only organic material can be composted, it is critical to effective handling of the entire waste stream, including plastics, due to the separation incentive and value contribution to the entire system. By 2014, San Francisco was diverting 80 percent of waste from landfills as a result of recycling and composting.<sup>[80]</sup>

at Recology. An increasing number of universities now collect and compost food waste from their operations.

Composting does have a few challenges: if the compost pile is not aerated (often simply by turning it over and mixing it), it can become anaerobic and this results in strong odors. Composting of municipal organic waste should be monitored for temperature for complete destruction of any pathogens in the material. A fairly large quantity of land is needed for municipal composting operations for curing the compost in windrows. In-vessel composting was popular about 10 years ago, but vessels were expensive and some had operational issues, so now most operations use grinders/chippers and turning equipment for windrow style composting.

## Investment Approaches for Recycling and Composting

### Investing in Recycling

Investors who want to drive increased use of recycled plastic feedstock can either invest in the companies converting plastic waste into something new and/or they can invest in the companies that are using these recycled feedstocks in new and innovative ways to further develop the market.

**Recyclers/Processors:** Processors take plastic waste material and convert it into new raw material or a new material or product. Processors are located all over the world, with many based in the U.S., Asia, and Europe. Processors are generally privately held but there are some established and even publicly traded companies with processing capabilities. In general, processors need capital to expand, to improve efficiency, and to adopt and scale new technologies. Here are four distinct types of processors:

- **Raw materials to flake/pellets:** Processors, sometimes called recyclers, are the companies that convert collected plastic waste such as plastic bottles into a new ready-to-use feedstock such as resin pellets or flake. Processors

range from large, high-tech operations to small, informal waste sector operations in some parts of the world.

- **Waste or raw materials to yarn or fabric:** These processors are taking plastic bottles and turning them into textiles, which is a very technology-intensive process. This space is populated with companies at various stages of growth – from early and later-stage start-ups to established public textile companies that have this as a capability.
- **Bottle-to-bottle:** Some processors specialize in bottle-to-bottle recycling, using both clear and colored plastic bottles. Some food and beverage companies have brought this process in-house to make their own packaging from recycled bottles.
- **Repurposers:** Some processors focus on the plastics that are not able to be truly recycled and find other ways to use the material. For example, hard to recycle items such as cigarette butts and baby food pouches are turned into a range of new products; mixed waste plastic is converted into reusable shipping pallets; and low-value plastic waste is being used as an ingredient in new roads. Other repurposed plastic products include plastic lumber, plastic bricks, and plastic park benches. These companies are typically privately held and many are currently investor-funded.

### Recycled Feedstock into New Products

Companies large and small are seizing the opportunity to use post-consumer plastic to make new, environmentally friendly products:

- **Eco-goods:** There is a cohort of smaller companies whose primary focus is making new products out of post-consumer recycled plastic. These include women's shoes, bags, children's toys, toothbrushes, razors and many other things. Investment in these companies would be some form of venture capital or venture debt to support expanding, scaling and access to new markets. Thus far these have been small and niche market operations as compared with their conventional competitors.
- **Mainstream:** A number of large companies are incorporating post-consumer recycled plastic as a



new feedstock in selected product lines including athletic shoes, cosmetics packaging, pens, and other items. Most of these companies are publicly traded. Some companies in this category may be open to project equity or debt financing. This circular loop for plastics is essential in reducing the use of virgin material.

- **Activist strategies:** The major consumer packaged goods companies are amongst the largest consumers of plastic both for products and packaging. Investor collaboratives such as the Investor Network on Climate Risk have used shareholder resolutions to compel major companies to disclose their carbon footprint and in some cases significantly reduce their greenhouse gas emissions. It might be possible for a significant group of investors to push the major corporate contributors to ocean plastics to disclose their use of, and ultimately increase the proportion of, post-consumer recycled plastics they use in their packaging and products.

## Investing in Composting

Composting investments can address the problem of ocean plastics in two main ways:

- Within an integrated waste management system, composting can be a source of revenue and can contribute to strengthening the overall economics of the waste management system, thus enabling better management of waste plastic.
- If producers dramatically scale up production of plastics such as PLA, which only biodegrades under certain conditions and which can be industrially composted, then there could be demand for increased capacity in industrial composting facilities to accommodate it. “Backyard compostable” plastics can be industrially composted but they do not require it.

Investments in composting can be structured in a variety of ways. At the largest scale, investor activism of large publicly-owned waste management enterprises

can encourage city-wide adoption of composting. There are also companies that offer composting at a city level but that operate independently of traditional waste collection. At a smaller scale, there are a number of companies making back yard anaerobic digesters. While these companies would seemingly displace potentially high-value compostable material from the waste stream, they are a good solution where composting is either not available or where waste collection in general is inadequate.

### Considerations

- **Commodity prices for virgin and recycled plastics:** Virgin and recycled plastic resins are global commodities and their prices fluctuate based on feedstock cost and global supply and demand. Most recycled plastic resins are only cost competitive with virgin resins when oil prices are high, and low oil and gas prices have made virgin resins cheaper than recycled resins, eroding their competitive position. Scale and efficient sorting can lower the cost of recycled material, but even this may not be enough to combat persistently low virgin material costs.
- **Demand risks:** Today, with virgin prices below recycled plastics for most resins, demand for post-consumer recycled feedstock is primarily driven by companies that see marketing value or have made public commitments to the use of recycled materials. An increase in the cost of oil and gas would drive virgin prices back up, restoring the recycled advantage and once again driving up demand for recycled resins. However, petrochemicals companies today appear to be betting on oil and gas prices staying low into the medium term and some of them are shifting production to plastic as a higher value end product.<sup>[29]</sup> As a result, analysts predict sharp increases in the supply of cheap virgin plastic resins, which would further undercut demand for recycled resins.
- **Supply risks:** Low prices for recycled plastic resin risk depressing collection levels, making it harder and/or more expensive to secure a supply of plastic waste to be recycled.



6







# Develop Responsible Waste-to-Energy Conversion Solutions

## Investment Focus #6: Develop Responsible Waste-to-Energy Conversion Solutions

**Provide financing for context-driven, environmentally and financially sound advanced Waste-to-Energy (WTE) technologies, such as gasification and pyrolysis, to underwrite scale-up risk from pilot to first commercial plant**

### Waste-to-Energy Conversion Technologies

Incineration, or the combustion of waste, is currently the most common form of WTE, but not the only one that exists (see Figure 30). This category also includes other forms of thermal conversion of waste, such as gasification, pyrolysis, and plasma arc technologies.<sup>[81]</sup> Although not directly WTE, byproduct gases generated from waste (e.g., through anaerobic digestion and landfill gas), can be used as a source of energy as well.

There are significant differences of opinion regarding WTE conversion technologies within the waste management industry, governments, and among environmental groups. Many types of WTE have been studied for conversion of plastic to energy and fuel at various scales <sup>[82, 83]</sup>, but there is not extensive use at commercial scales yet for various reasons touched on later in this section. More time and resources are needed to determine if and under what circumstances the technology is viable at larger scale.

While WTE has been shown to have life-cycle assessment (LCA) benefits (e.g., energy production and off-sets) in individual case studies, the results depend on the definition of the system boundaries, functional units and waste composition, as well as local environmental and regulatory conditions, all of which can vary significantly. In a review of 136 journal articles on WTE LCA <sup>[84]</sup>, about 25 percent of the studies were completed on a single fraction of waste, and another 25 percent on mixed municipal waste (for example, sludges and industrial waste). The assessment of these studies shows significant inconsistencies on the information compiled, making comparison between studies and broad conclusions difficult. Thus, generalizations about benefits and burdens across these studies cannot be stated, since site-specific conditions and local issues vary so much. This includes analyzing energy off-sets, which are entirely dependent on the current source of energy (the energy source that would be replaced by WTE). For example, there are more benefits to off-setting coal with WTE than off-setting natural gas. Additionally, the majority of studies examined do not address the costs and environmental burdens associated with air pollution control (APC) or residual (e.g., ash) management.<sup>[84]</sup> These are both critical to protecting the environment, human health and safety, and so cannot also be generalized. In most cases, however, WTE facilities are expected to meet all national and local regulations, realizing that these differ and may not even exist everywhere.

Figure 24

Waste-to-Energy Technologies

Source: [81]

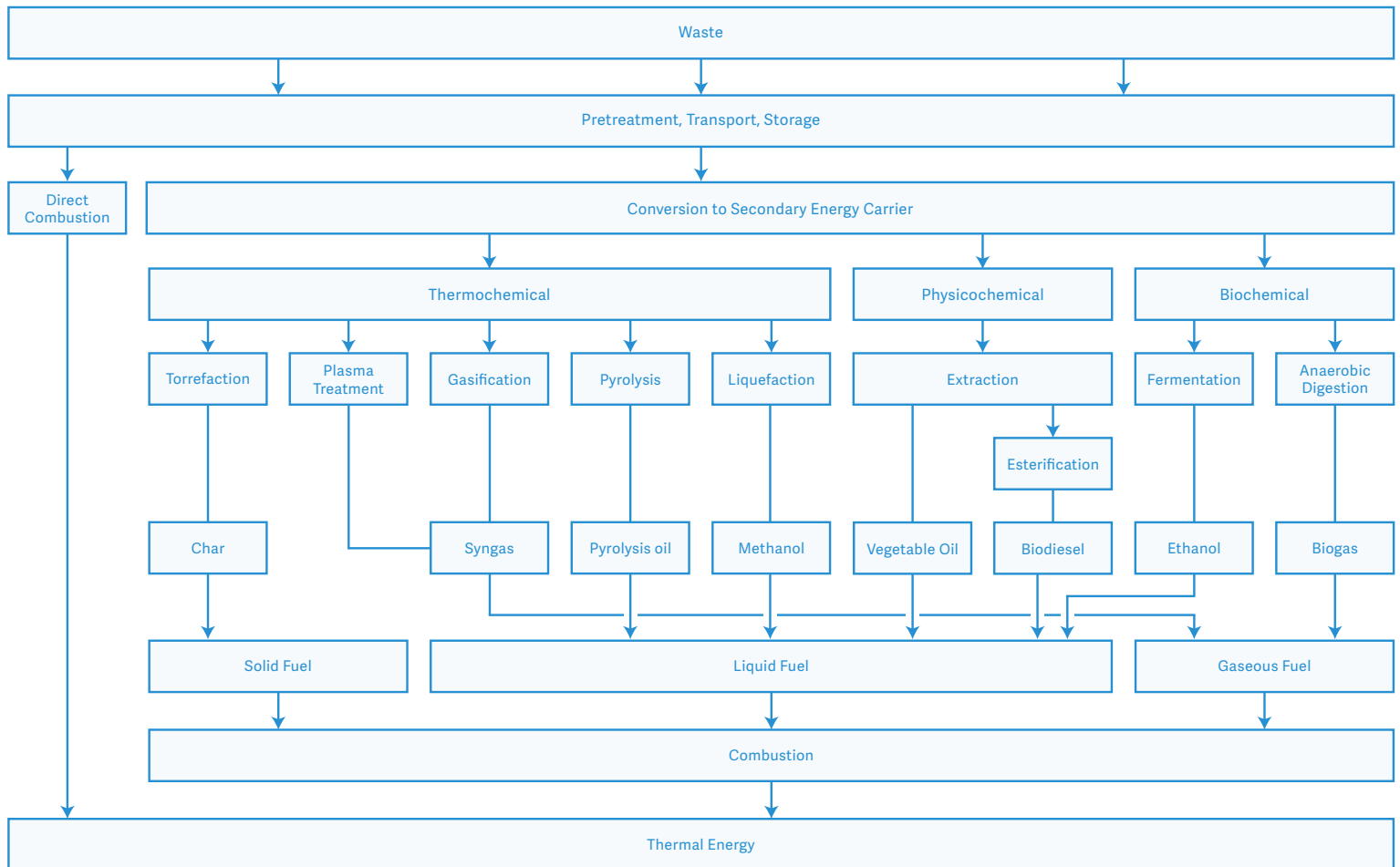

Just as demand for recycled materials can increase the value of waste, WTE can also increase the value of the waste stream, potentially creating economic incentives for more robust collection services. While WTE technology has improved over the past 20 years, much of the discussion and conclusions of Miranda and Hale (1997) still hold today: in a social cost analysis and comparison of WTE in the U.S., U.K., Germany, and Sweden, it is clear that local context plays an extensive role. While WTE can provide waste management, along with energy and in some cases heat, WTE can also create a demand for waste in order to keep a

facility in operation.[85] Some say this demand can be counterproductive to waste reduction and recycling efforts, while others argue that in the proper context and regulations, recycling rates can remain relatively high. Thus, the option to produce energy from waste could inhibit motivation for renewable energy sources and recyclable product designs. Such designs are an upstream component of the plastics management issue, given that currently about half of the packaging plastic waste stream is non-recyclable, either technically or economically).[86] In addition, if waste reduction efforts are successful, then the catchment

area for waste must be increased. This can include the importation of waste, even from other countries.[\[87\]](#)

To date, WTE has predominantly been used in high-income countries, but it has also attracted interest from rapidly developing countries. Many of the low and middle-income countries that struggle to provide sufficient waste management services are also challenged in providing reliable electricity. Also, while governments have been reluctant to directly subsidize collection, some have been willing to subsidize WTE facilities through tipping fees and feed-in tariffs. [\[88\]](#) However, based upon interviews for this work, some WTE projects have failed for reasons including environmental issues, improperly received Feed-In Tariff subsidies, and failure to generate promised economic returns.

In considering investment in WTE technologies, it is important to remember the circumstances in which the facility will operate. While some technologies are able to handle the waste streams found in low- and lower-middle-income countries, particularly Southeast Asia, most of the conversion technologies, such as gasification and pyrolysis, require consistent and uncontaminated streams of waste. This makes them best-suited for deployment in OECD countries, at least initially, or until there are further technology developments. To that end, the deployment of these technologies in OECD countries can help improve them and lower their costs to the point where they may one day be deployed in developing countries.

Clearly, WTE investments require careful due diligence for financial and environmental viability to ensure the greatest possible chance of being success stories rather than cautionary tales. Investors interested in exploring WTE investments should consider all possible benefits, costs and risks associated with WTE. Options for investment in WTE are examined in this section. The Additional Levers section highlights the areas where further research is needed to better inform these choices.

## Overview of Technologies

### Gasification

Gasification uses a high temperature process that combines anything containing carbon with controlled amounts of oxygen to produce syngas. Syngas can be used for energy production or processed into a replacement for natural gas, hydrogen, or into value-added products such as liquid fuels and chemicals. While the syngas may need to be scrubbed before it can be sold as product, emissions are minimal in contrast to the emissions challenges of more straightforward combustion. According to the Gasification and Syngas Technology Council, about 300 gasification facilities exist worldwide, though many others have closed, citing economic and other challenges. These gasification facilities work with biomass, waste, coal, gas, petcoke, petroleum, and other materials.

Gasification is not a good solution when there are significant fluctuations in the waste stream; the feedstock needs to be relatively consistent. Each gasification plant is optimized for a certain feedstock, so there is little flexibility (at least with current technologies) in what can enter the gasifier. While some can take more heterogeneity, the gasifier will operate more smoothly and create a more reliable product(s) with a consistent input. Also, operation and maintenance require fairly high-level technical training and trained technical staff is critical to expansion.

While the heterogeneity and unpredictability of the municipal waste stream can make gasification difficult to implement, the technology does have the advantage of being able to work with smaller quantities of waste. Additionally, it brings another revenue stream to the waste management process, can create value-added products, and can work in places where waste is a problem and energy is expensive (i.e., small island states). For all these reasons, gasification has potential for future growth.



## Pyrolysis

Pyrolysis is a high-temperature process that combines anything containing carbon (without oxygen) to produce gas, liquid, and char. Pyrolysis can create heat for energy recovery at the same time that it produces value-added products like fuels. While the gas created may need to be scrubbed before it can be sold as product, as with gasification, there are no other air emissions from this process. Emissions are generated when the fuel is combusted.

Pyrolysis is also an attractive option from an environmental perspective because, in contrast to many gasification plants, pyrolysis companies pay for the waste they use, increasing its use by waste collection companies.

Similar to gasification, pyrolysis works better with a consistent feedstock since the process is designed for the desired feedstock. With the inexpensive price of petroleum, the value added from pyrolysis to fuels might not be economically viable – although there could be potential for specialty fuels and products, such as recycled polystyrene and jet fuel. The low price of oil has meant that for companies with high built-in costs and an inability to evolve, the past few years have been difficult, with several companies entering bankruptcy.

Theoretically, pyrolysis can also handle smaller quantities of waste. This, in addition to the added revenue streams from value-added products, means it can work in small areas, such as islands. This is not always the case, though, as some companies that focus on certain plastic products exclusively require larger populations to meet their minimum feedstock needs. Additionally, as in many businesses, these companies show better economics with scale.

Here again, the heterogeneity and unpredictability of the municipal waste stream can make the use of pyrolysis difficult. Requiring purer waste streams than either gasification or incineration means that pyrolysis facilities require substantial investment in sorting or changes in the methods of source-segregation of waste material in addition to their own capital costs.

## Anaerobic digestion

Anaerobic digestion is the controlled decomposition of biodegradable materials in a system without oxygen. The gases produced are methane and carbon dioxide, which can be used to create electricity in internal combustion engines, turbines (also co-generation), and boilers. Anaerobic digestion of agricultural waste and in wastewater systems is more common than AD of municipal solid waste, but co-digestion of food waste has been conducted at industrial, agricultural and wastewater facilities.

Anaerobic digestion can also produce other byproducts that can add to the waste's value generation. Many AD facilities, for example, yield fertilizer in addition to energy. This can be sold commercially, typically at a slight discount to traditional fertilizers.

Interestingly, many biodegradable polymer manufacturers are eyeing AD, along with wastewater treatment plants, as a source of feedstock for their inputs. PHA/PHB makers such as Full Cycle Bio-Plastics and Mango Materials are all co-located with either AD facilities or wastewater treatment plants. This circular application could fully close the loop by creating another biodegradable product with AD output.

Since this is a microbial process, there are potential issues. Anaerobic processes produce strong odors, and there is the potential for fugitive odors in this process if the facilities and processes are not well-engineered. Also, there can be disruptions to the microbial processes if the organic materials change significantly or there is some other disruption. The system needs to be continually monitored for optimal microbial activity to occur.

## Other Waste-to-Energy options

### Incineration

Incineration is the combustion of a mixed stream of waste. Electricity can be generated through steam generation and a turbine, but the capture of the heat is also used through steam or water piping systems. Co-generation (capturing and utilizing heat and creating electricity) is also possible. Combustion reduces the

volume of waste by 70 to 90 percent with the remaining ash (bottom ash) needing to be managed, which is typically done through landfilling. The advantages of combustion with energy recovery are that it is capable of taking on a more heterogeneous and mixed waste stream than any other WTE technology, though certain unsuitable items such as pressurized tanks, gasoline and bricks, are still removed before combustion. While newer combustion facilities are typically required to have strict environmental pollution controls [89], these greatly contribute to the cost of the facility and there is a lack of public trust that these will be consistently and correctly used and monitored. Air-pollution control (APC) systems generate fly ash from their capture of particles and this must be managed along with the bottom ash from combustion. Properly managing these materials is critical since the inorganic contaminants (e.g., metals) get concentrated in the ashes. Additionally, even regulated air emissions release pollutants into the environment below regulatory standards (just like any other combusted energy source with air emissions), with dioxins a particular concern for waste, so they should be compared to other sources of energy through a standardized process like a life cycle assessment (LCA) [84]. This includes analyzing energy off-sets, which are entirely dependent on the current source of energy (the energy source that would be replaced by WTE). For example, there are more benefits to off-setting coal with WTE than off-setting natural gas. Other issues with combustion facilities are that they have high capital costs, as well as operation and maintenance costs, and they require a baseline waste input to operate and produce electricity, which has led some countries like Sweden to need to import waste to keep their facilities operational.[87]

The U.S. currently combusts about 13 percent of waste [37], while in the EU plus Norway and Switzerland, 39.5 percent of the 25.8 million metric tons of plastic in the waste stream was combusted with energy recovery.[9] In 2015, 32 percent of Chinese waste was incinerated [90], and in Singapore nearly all non-recycled waste (38 percent) is incinerated.[91] China has been rapidly scaling up its incineration efforts and Indonesia is considering expanding its number of incinerators as well.

**Plasma Arc** is similar to gasification but it uses a plasma arc as the heat source, leading to higher temperatures. The extreme high heat makes this technology appropriate for certain hazardous wastes. As it uses more energy than it produces, plasma arc would not make sense to scale from an energy production perspective, and is difficult to justify for economic reasons as well.

### **Landfill Gas**

While landfills are not the best place for plastic to end up, they are also not the worst. A well-designed and managed sanitary landfill will prevent plastic from entering the ocean, and can generate revenue from landfill gas in addition to tipping fees. It should be noted that since plastic itself does not biodegrade, the landfill gas generated in the discussion here comes from other landfilled biodegradable materials disposed along with the plastic. In some cases, many of these materials are banned from landfills (e.g., yard waste) or targeted for composting instead (e.g., food scraps).

Although engineered facilities are still fairly complex, they can also be more straightforward to operate than conversion facilities. Engineered facilities are designed with liner systems, collection of the liquid that percolates through (leachate), and collection of the gas that is generated.

When biodegradable organic materials are sent to a landfill, they decompose under anaerobic conditions, and generate primarily methane and carbon dioxide. Since methane is a potent greenhouse gas, the emissions should be combusted in a flare (converted to carbon dioxide), at a minimum, but also can be used beneficially for energy and heat with sufficient quantities to run internal combustion engines, turbines, co-generation, and boilers. Landfills can also be set up to feed energy back onto the grid and receive revenue from relevant feed-in tariffs.

In some cases, conversion of landfill gas from methane to carbon dioxide (with or without beneficial use) can be considered to be avoided carbon emissions. This conversion may be claimed as carbon credits in some instances as well.

**Figure 25**

Example of Potential Revenue of Waste Conversion Outputs from Prepicked Municipal Solid Waste

Source: [28]

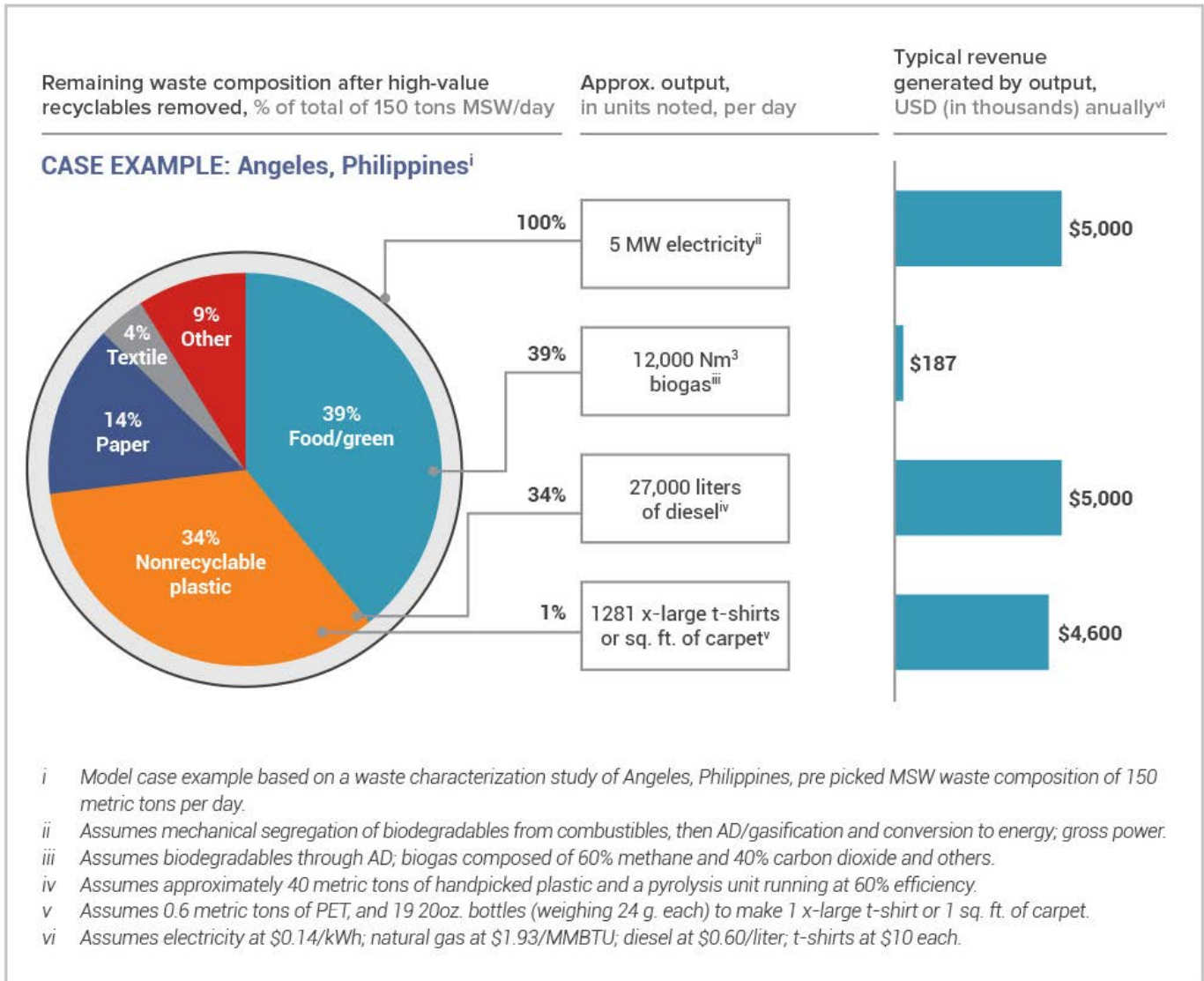

Ocean Conservancy team analysis, with data from Waste2Worth Innovations, 2016.

Ash or process residuals from the conversion processes also need to be landfilled. An engineered landfill facility is required for ash from a combustion facility. Ash can concentrate certain compounds that are not destroyed by combustion (e.g., metals) and ash leachate may need more specific treatment methods (e.g., can be high in salt content). No gas is created in ash landfills.

Landfills are the most common solid waste management method in the U.S., with 52.6 percent of its waste landfilled in 2014. Landfilling plastic that is not biodegradable does not create any carbon emissions in the landfill setting. Landfills simply store plastic waste.

While other technologies and recycling provide some outlets for waste, landfills will likely be needed for the foreseeable future. Construction and operation of landfills are less technology-intensive than combustion facilities, but engineered facilities do require specific design and training for operators.

## Investment Approaches for Waste-to-Energy

### Opportunities by technology

- **Anaerobic Digestion:** Anaerobic digestion generates energy and fertilizer from organic matter in the waste stream. This makes it a compelling solution for many Southeast Asian countries where organic matter makes up the largest part of the waste stream. Additionally, because AD can be deployed at anywhere from micro-scale to large-scale, it can be a solution for many small island states where unsanitary waste management and high energy prices are the norm. Investments can be structured as equity in companies (typically fairly large scale) or as investments in individual projects. By promoting AD, investors would be adding more value to waste and helping sort the waste stream, thereby adding value to the collection and recycling of plastic.
- **Pyrolysis:** This technology is particularly interesting as it focuses exclusively on plastic in the waste stream and can create a variety of

high-value outputs, such as diesel, naphtha, and syngas. However, because of its requirements for essentially clean plastic, it has, to-date, been deployed in advanced markets with thorough waste sorting. Investments in either projects or companies today may provide for research that allows a dirtier, wetter waste stream to be handled in the future, but this remains a challenge with today's technology. If the cost and efficiency of this technology improve, it might also be deployed in countries that contribute substantially to the leakage of plastics into the ocean. Example companies/processes include:

- RES Polyflow is a pyrolysis company capable of handling a diverse stream of plastic waste, (with the exception of PVC). They have one small demonstration project operating in Ohio, but have plans to expand throughout the Midwest and ultimately further. Their process yields either naphtha or diesel along with char and wastewater.
- Vadxx is another pyrolysis company working on their first demonstration project. With financing secured from the Closed Loop Fund and others, they plan to expand operations within a year.
- Agilyx is a third pyrolysis company raising money currently. They offer both mixed plastic pyrolysis technology as well as polystyrene recycling. Given the low cost of recycled plastic, they have pivoted to spend most of their energy on the polystyrene recycling technology. This lightweight plastic has been notoriously difficult to manage, and a company that is able to create a circular application for it could make a huge impact in the long run

- **Gasification:** As a cleaner alternative to combustion that can accommodate a more diverse waste stream than pyrolysis, there appears to be some growth potential for the gasification industry. Today, however, these plants typically require large scale and often require particularly high tipping fees and/or feed-in tariffs to generate returns for

investors. Additionally, many of the first plants built struggled to break even; several have closed. As such, investors in this space need to pay particular attention when considering the optimal places to deploy gasification technology.

- **Combustion:** Despite the risk of environmental damage and generally negative profile of this technology, many communities and countries are pushing forward with plans for combustion with energy generation. For investors, this is both a risk and an opportunity, as the market could grow to be quite large, but could also diminish based on political pressures. Investment in this space can range from equity investments in large multi-national combustion companies, municipal debt for communities building these projects, or project level finance (debt or equity). There might also be venture investments in companies developing new technologies in this space. It is worth noting that many environmental advocates fiercely oppose combustion claiming that it causes more problems than it solves.
- **Landfill Gas:** This mode of energy production takes the methane generated from sanitary landfills and combusts it for energy generation. These projects are typically constructed by some of the largest environmental engineering and waste management firms in the world. This means that for investors, there are many ways to invest in these projects, either as equity investments in the companies that make this technology, project investment (often alongside DFIs in middle- and low-income countries), or by investing in the engineering firms that implement these technologies.
- **Plasma Arc:** Plasma arc is not currently commercially viable for mixed plastic waste streams, given its need for enormous amounts of energy. In niche applications, such as processing certain hazardous wastes, it can be appropriate but it is unlikely that it will be useful in combatting ocean plastics.

## Considerations

According to some, WTE offers an opportunity to quickly and drastically reduce the amount of plastic (and organic) waste that enters either landfills or the ocean. Both large- and small-scale energy generating facilities take otherwise low-value plastic or organic matter and convert it to energy (some people even consider this form of energy as renewable, though others dispute this moniker). If successful, these technologies can reduce the physical strain on overflowing landfills and financial strain on waste collection companies that may be able to reduce the tipping fee cost associated with delivering their waste to landfills. However, WTE investments can be controversial, as many in the environmental community are skeptical of their reported emissions data and object to feed-in tariffs, originally designed to support renewable energy, being used to subsidize the thermal destruction of waste. Additionally, while many untested WTE facilities appear on paper to be commercially viable, many operating facilities have failed to generate sufficient economic returns.







7





# Support Integrated Waste Management Solutions

## Investment Focus #7: Support Integrated Waste Management Solutions

**Provide financing for facilities and/or services that are part of integrated waste management solutions in countries with low rates of waste capture and high leakage in areas of Southeast Asia, Africa, and Latin America**

In 2010, the majority of ocean-bound plastic originated in rapidly developing middle-income countries and it is estimated that China, Indonesia, The Philippines and Vietnam combined contributed about 50 percent of the plastic going into the ocean in 2010.<sup>[1]</sup> The plastic waste entering the ocean is the result of a combination of two key local factors: a large number of people living near the coast and high rates of mismanaged waste. Each of these countries has experienced rapid economic development, and the waste management infrastructure has not been able to keep up with growing waste production. But on the development scale, some countries in Africa are not far behind, and some infrastructure is also lacking in Latin America where there are large coastlines. This means that addressing ocean plastics in a meaningful way will require improving waste management in countries lacking infrastructure all over the world and getting ahead of the curve in countries where rapid economic development is predicted to occur.

In order to solve this problem, all countries will need adequate waste management systems. It is clearly

important to find solutions that are suited to current countries where high impacts are observed, while simultaneously considering how those solutions can be applied to other countries facing similar challenges. In some cases, there is an opportunity to proactively prevent waste management crises before they occur.

The central challenge of waste management infrastructure development is an economic one: it is difficult to cover the cost of comprehensive formal collection with the sources of revenue within the waste management system, e.g., collection fees, recycling, composting, and WTE feed-in-tariffs. In general, there may be insufficient ability and willingness to pay collection fees where infrastructure is lacking. Additionally, charging fees can increase the risk of illegal dumping. This leaves many municipalities unable to fully fund ongoing collection and lacking waste management equipment and infrastructure.

There are opportunities to generate revenue throughout the waste value chain by recycling, composting, and possibly WTE technologies (where these are deemed to be environmentally sound and financially viable in a given context), but their economic viability is dependent on a mix of commodity prices and regulated sources of revenue such as feed-in tariffs and tipping fees, and is subject to supply risk (the quantity and composition of the waste they receive), political risk, contract/counterparty risk and risks from corruption. Since there is not enough inherent value in the waste itself to cover the cost of collection, and many who generate

the waste are either unwilling or unable to pay for its management, this leaves waste management systems woefully underfunded.

While there has been investment from Development Finance Institutions (DFIs) in waste management in Asia, the amount reaching the countries with the biggest need has been insufficient. Countries in Africa and Latin America have received even less funding. For low and middle-income countries, DFIs provide the vast majority of the solid waste management investment; however, this funding represents just 0.3 percent of the DFI budgets and two-thirds of it has gone to just 10 middle-income countries. In contrast, water and sanitation receive 7 to 8 percent of the DFI budgets, or more than 15 times the amount that is spent on solid waste management.<sup>[17]</sup> In some cases, water

agencies may play a role in solid waste management, but even if some of that 7 to 8 percent were going to solid waste management, the discrepancy would still be quite large. Seen as an immediate need, water and sanitation infrastructure has historically preceded solid waste management, but because of the sharp increase of plastic in the waste stream, solid waste management should be addressed concurrently with other environmental development issues.

Primary DFI funders of waste management have been KfW Development Bank, The Asian Development Bank (ADB), The Japanese Government, The Infrastructure Development Bank (IDB), and the Global Environment Facility (GEF). These groups primarily give grants or concessionary loans, though the ADB and IDB also provide large amounts of non-concessionary loans.<sup>[27]</sup>

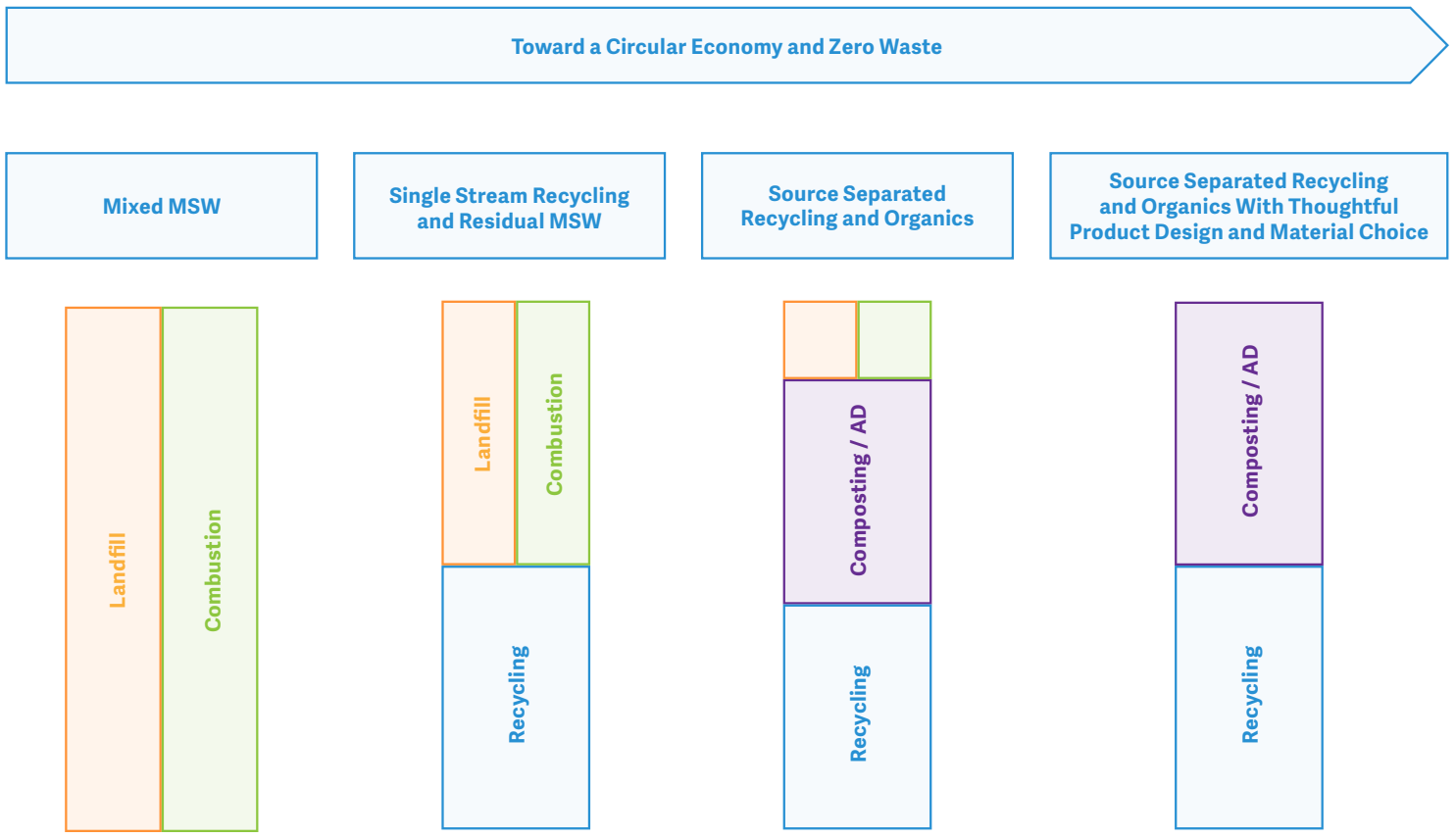

**Figure 26**

Value Extraction from Waste  
Dependent on Upstream Choices

## Waste to Worth

Waste to Worth (W2W) started as a project to advance Procter & Gamble's stated sustainability goal to end consumer and manufacturing waste ending up in a landfill in low- and lower-middle-income regions. Led by retired P&G employee and W2W team leader, Jill Boughton, this project is working to launch a business portfolio managed by SURE Global W2W. The cornerstone of the W2W business model is leveraging multiple technologies to extract the maximum value from waste for the local economy while developing sustainable and economically viable waste infrastructure. Their future revenue generating outputs will include energy, fuels, gas and recyclables. W2W plans to extract enough value from waste (received for free) to make the economics work. SURE Global W2W currently has four major projects in planning and development in the Philippines, all of which have been supported by P&G and the Asian Development Bank (ADB), which provided funding for feasibility stage analysis. Together the projects are expected to be able to mitigate over 1,200 tons per day of municipal solid waste. Additional projects in the pipeline are expected to mitigate an additional 1,600 tons per day in the Philippines and Indonesia. SURE Global W2W is actively working with APEC and government leaders in Southeast Asia to develop policies and conditions for accelerating W2W constructs across the region. Boughton claims that with a vertically integrated waste management systems, W2W will be able to realize efficiencies and economies of scale.

Additional DFI funding and infusions of private capital will be required in the near-term to increase collection rates and decrease the amount of mismanaged waste. Over time, rising incomes from economic development should increase the ability of citizens and government to pay fees that cover the cost of collection, which may also enable those who invest now to receive a respectable return later.

**Design considerations for waste management systems**  
To craft an optimal investment strategy, the waste management system must be considered as an integrated whole. The seemingly discrete, sequential stages of the waste management value chain are more like an ecosystem than an assembly line. Decisions made at the front end of the system starting with collection determine what can be done with the waste stream and the economics of those options through the value chain. Conversely, the existing infrastructure largely determines the options for what happens to the waste once it is collected and may dictate the manner of collection. Optimizing one stage of the system has dependencies on what comes before and implications for what comes after. An extreme illustration of this shows how, in a perfectly designed system, such as that imagined in an ideal circular or zero waste economy, "waste" is designed out of the system, as illustrated in Figure 32.

Economic modeling of the waste management value chain suggests that full vertical integration of waste management may enable investors to capture the greatest value and most effectively minimize risk. Where investment in a fully vertically-integrated solution is not feasible, investors should seek to recreate, through contracts and other design structures, the conditions of vertical integration to the extent possible. Investors will also want to take the time to understand the full system in which their piece fits to enable a comprehensive and informed approach. Further, it must be noted that there is no one-size-fits-all solution: the diverse successes and failures of waste management systems across these countries are grounded in each locale's unique economics, demographics, politics, history, culture, geography and built environment.

The role of the informal waste sector workers is another important consideration for the design of integrated waste management systems in Asia, Africa, and Latin America. The high-value plastics are typically removed from the waste stream for recycling through picking by formal and/or informal waste sector workers either during or shortly after collection or dumping. Rather than see this as a threat to the economics of the system as a whole, it is an efficient and effective



way to prevent those plastics from entering the ocean, while also supporting entrepreneurial livelihoods for millions of people. Hopefully, designing solutions for picking will continue. There are examples of programs that successfully incorporated informal workers into formal collection systems, so that may be considered as an option as well.

In considering solutions, the question has come up: if plastic waste is the problem, could there be targeted collection and disposal solutions just for plastic? The short answer is no. The high-value plastic waste is already being thoroughly collected and recycled by the informal waste sector pickers, so the solution would need to target just the low-value plastics, things like plastic bags, personal care product sachets and chip bags. Unfortunately, by definition, these items do not have enough value to support targeted solutions. Caring about plastic waste in these countries, it turns out, means caring about all waste in these countries. That said, there are groups experimenting with targeted collection solutions that engage the informal waste sector for both low- and high-value plastics (discussed in “Engage and Support the Informal Waste Sector”) which are worth pursuing, but should not be relied upon to solve the challenge of plastic waste management in Asia at scale in the near- or medium-term.

Given these considerations and constraints, creative project developers and investors are finding ways to make viable investments by designing vertically-integrated waste management solutions that draw on diverse sources of investment capital and revenue, mitigate the biggest risks, and are designed to work within the unique local context.

The Ocean Conservancy has examined potential solutions to the challenges of waste management in the Philippines, Vietnam, and Indonesia, in particular, and their findings are consistent with this approach. Their findings and recommendations are detailed in a report called *The Next Wave* that is planned for release in the first quarter of 2017.

## Investment Approaches for Integrated Waste

Management in Asia, Africa, and Latin America  
Investments in integrated waste management in the key source countries of Asia, Africa, and Latin America are an important step to reducing the leakage of plastic waste into the ocean in the short-term. As has been discussed, the fundamental problem in these countries is that the collection of waste costs more than the waste can currently generate in revenue. As such, there are two ways that investment might be able to help address this problem: 1. Increase the value of waste once it is collected, thereby increasing the incentive for businesses and waste pickers to collect waste, and 2. Make the collection, processing and disposal of waste more efficient by vertically integrating all aspects of the waste management process, thereby capturing efficiencies and economies of scale. However, as has been noted, this may not fully solve the problem, and there will likely still be a need for local governments, development aid agencies, DFIs, and philanthropy to help subsidize the collection of waste until there is an ability to pay for this collection or other ways can be found to pay for it.

From an investment standpoint, three primary approaches could be considered when investing in this space: 1. investing in companies and projects that are trying to capture the efficiencies of vertical integration by offering an entirely integrated approach themselves; 2. investing in companies that might fit into a larger waste management system, but only play one role in the system themselves; and/or 3. investing in technologies that materially increase the amount of revenue that might be captured from a unit of waste.

In OECD countries, vertical integration is common and these vertically integrated waste management solutions are typically operated by large publicly-traded firms. However, these companies have generally not penetrated the key markets in Asia, Africa, and Latin America due to perceived economic challenges, political risks, and transparency issues.

If an investor is interested in investing in a whole integrated system, there are relatively few options to pursue.

Because of this, investments must either be structured to incentivize these existing firms to enter new markets or to allow new firms to grow in these markets. These investments could be either:

1. Project/debt investments with large international waste management firms to encourage their investment in key low- and middle-income markets,
2. Smaller private equity/venture investments in emerging companies in Asia, Africa, and Latin America that are trying to vertically integrate waste management services,
3. Private equity/venture investments in individual waste management companies in Asia, Africa, and Latin America that are trying to solve specific waste management problems in a given country; and/or
4. Private equity/venture investments in technology development companies that are trying to improve the effectiveness of waste to value technologies (e.g., gasification, pyrolysis, de-polymerization).

It is worth noting that this last type of investment might actually mean investing in technology companies, technology development, and technology deployment in middle- or high-income countries, with the hopes that eventually these technologies would make their way to key Asian, African, and Latin American markets. Needless to say, this could take some time and may not actually happen at a rapid enough pace.

Of these four approaches, the most effective at actually slowing the flow of plastics into the ocean at scale and in the short term are likely to be the first two, since they address the key issue of better collection and disposal. However, **there currently appear to be very few initiatives to vertically integrate waste management approaches in Asia, Africa, and Latin America.** It is unclear that, at the present time, it is possible to deploy a significant volume of capital into these first two approaches. Given this lack of existing

waste management infrastructure in many markets, the more piecemeal approach of #3, that seeks to invest in individual companies that control one or more parts of the waste management system, may be more appropriate. These could target the following pieces of the waste management chain:

- **Collection:** The bedrock of any integrated waste management system must be collection, and in key Asian countries, collection rates are precipitously low. That said, there are privately owned companies in many of these countries that currently have collection contracts and could expand their operations with additional investment. These companies tend to have revenues of <\$10 million. Several multi-national companies also operate in more established markets in Thailand and Indonesia, as well as several publicly traded companies local to the country. Local holding companies and family offices have been able to access this sector but it has been difficult for foreign investors to become involved. The revenues are tied largely to contracts with local municipalities, so security of those contracts are key to this business model, and investors need to be wary of the potential for corruption in these contracts. Another method would be to engage the informal waste sector by supporting waste worker cooperatives and others in building decentralized collection networks that feed into local MRFs. Collection can also be a good place to implement a Pay-for-Performance arrangement with funders working in partnership with municipalities.
- **Sorting:** For companies that send waste directly to landfills, it might be possible to invest in sorting capabilities (infrastructure or companies) that could allow for the more efficient extraction of value from collected plastics. The most efficient way of doing this is in source separation, but where that proves challenging or unpopular, sorting may have to be done at MRFs. These investments tend to be through project equity or by expanding the scope of existing waste management companies. Sorting on its own, however, is not generally



profitable unless the sorters are being paid by processors farther down the value chain or generating savings for waste collection companies by reducing the waste sent to landfills. For this reason, some level of vertical integration between sorting and recycling/WTE makes sense.

- **Recycling:** Recycling in many low- and middle-income countries is typically done informally, via a robust system of junk shops. Working with these dealers, there are companies focused on connecting recyclable waste to the international market. Some of these might provide interesting investment opportunities, though given the current low cost of oil, these are unlikely to be very profitable investments at this time. Additionally, there may be an opportunity to invest in infrastructure that allows for more recycling to take place.
- **Energy generation:** Whether from organic waste or plastic waste, there can be value in extracting the energy from any given waste stream. Once sorted, waste that enters these facilities can generate revenue that provides compelling returns to investors. Many WTE projects in China have been financed through private infrastructure funds and through large publicly listed companies such as Covanta, Hitachi Zosen, Wheelabrator, and China Everbright. In Indonesia and the Philippines, many projects are at the development stage and there are opportunities to invest in this relatively high risk/high return early stage development phase. As the projects receive permitting, the risk to project equity and debt providers decreases, while the reward increases, and there is a range of opportunity for international private equity, project equity and project debt to invest. Again, the key here has to do with the reliability of waste stream in both quantity and quality. Thus, in a sense, the ability to make money at this stage of the process depends on how collection and sorting is done, as well as on the efficiency of the conversion technologies. Additionally, these investments are often dependent on generous feed-in-tariffs or tipping fees, and changes in policy may impact the facility's ability to generate revenue. Without subsidies, investment in these technologies would look a lot less profitable.

Additionally, investors need to be diligent to vet all aspects of their projects to ensure they minimize pollution and that they meet best practice standards for emissions.

- **Sanitary landfilling:** Even with investment in waste conversion, there will still be a need for sanitary landfills. Landfills generate revenue via tipping fees (i.e., they get paid by other parts of the waste management chain, or by governments) and sales of landfill gas and/or energy derived from landfill gas. While many are owned by municipalities or collection companies, there may be opportunities to invest in their improvement and operations. These are typically small private companies and/or project equity opportunities.
- **Composting:** Several companies work exclusively with organic waste to generate either fertilizer or compost. These companies have been slow to develop, however, as there is a strong cultural bias against using organic waste for agricultural purposes. Outside investment could spur growth in these companies and promote a greater export orientation.

### Considerations

- **Emerging market risk:** Most of these investments will be subject to emerging market risk and political risk. In other words, if governments change their minds and change who is awarded a waste management contract, this could doom some of these investments. Likewise, of the 500 largest cities in the developing world, only 4 percent have sufficient credit to access municipal debt markets. The rest are not deemed credit-worthy, which means the risks are considerable.[17]
- **Short-term contracts:** Many waste contracts in key countries are typically short term in length. This adds risk for investors who may be considering large infrastructure investments that require payback over long periods of time.
- **Technology risk:** Some WTE technology may be unsuitable for the waste streams in many low- and middle-income markets due to the high organic content of the waste.

- **Debt vs. Equity:** While many private companies perform waste management services in these countries, a bulk of the waste management work is done by municipalities. Therefore, there are opportunities to invest in either municipal or corporate debt as well as public and private equities.
- **Layering capital:** In many instances, the residents of high impact countries are unable or unwilling to pay for waste management. Therefore, it may be necessary to layer in concessionary capital from organizations such as the World Bank, USAID, and other development finance institutions together with private capital. This could help reduce the risks or increase the rewards of investment for the private capital providers and may, realistically, be required before there is any meaningful private investment in this space.



# Additional Levers



**Photo Credit:** Plastics for Change - Bangalore Program

---

**A** discussion of the investment opportunities to reduce the flow of plastics into the ocean would be incomplete without recognizing other key levers for change and their ability to amplify the impact of investment. Philanthropy, citizen engagement, and government policies and actions can complement and strengthen the investment opportunities outlined in this report. Work in these four areas can inform, catalyze or support future investments, and all are important for investors to recognize as part of the broader context of work on ocean plastics as they begin to structure investments around this problem.

This report does not attempt a full accounting of the philanthropic, citizen engagement and government efforts going on worldwide to address this problem, but rather provides selected highlights from this landscape most relevant to the investment strategies described in the previous sections.

To date, most of the action to stop the flow of plastics into the ocean has come from philanthropists, NGOs and activists, and government policy change. There have been notable achievements, such as microbead

and plastic bag bans and the Circular Economy policy work in the EU, and there have been a range of successful efforts to raise awareness of the issue globally, from documentary films to compelling public awareness campaigns to volunteer beach clean-ups. Some governments and philanthropists have also funded research efforts to spur innovation in material engineering.

There are also clean-up efforts which, while noble in their intentions, are not the best use of resources dedicated to addressing ocean plastics. Cleaning plastic pieces out of the five ocean gyres, for example, is not only likely impossible, but it would hardly make a dent given the volumes being added back each year.

It is worth noting that the bulk of the efforts to date have focused on downstream actions to address the problem rather than upstream efforts that attempt to prevent the problem from occurring. While both upstream and downstream solutions are needed, there is an opportunity to emphasize high-impact upstream strategies where these additional levers may be combined with new investment to drive greater impact.







# Philanthropy

## Additional Lever #1: Philanthropy

**Use catalytic philanthropy to spur innovation in material design, waste collection, and other sectors**

Philanthropy can be used catalytically in many ways to unlock new investment possibilities. Given the investment focus areas discussed above, the philanthropic opportunities prioritized here are: uncovering new solutions through research and development; supporting higher-risk, high-impact investments; and offering market-altering prizes that may spur new innovations.

The following provides a brief overview of these opportunities.

### Supporting Research and Development

Many potential solutions to the ocean plastics problem await discovery in laboratories and research universities around the world, but much of the research is too early-stage to attract investors. Using philanthropic funds to support these foundational efforts builds the pipeline of new discoveries and sets the stage for investment funding to support the subsequent stages of work.

## Material Engineering

Much of the cutting-edge research taking place today occurs at not-for-profit universities. These researchers often face a funding gap between their university/government funded research and full-scale commercialization. This leaves many promising innovations in a “valley of death” where they are too large to be funded for purely academic reasons, but too small and unproven to receive venture capital. For these innovations, incubator programs, lab space, and continued research funding could be transformative. Some groups, such as Think Beyond Plastic, are already doing work like this, but their efforts could be expanded with funding or complemented by the addition of other incubator programs in this space.

This work would be considered catalytic for future investment, as the innovations funded by this type of philanthropy could yield new commercial ventures. Additionally, it may encourage additional government or university support for even more nascent technologies, as successful research initiatives gain publicity. In all, this could transform the material engineering sector and help it fulfill the needs outlined in “Accelerate and Scale Better Materials.”



## Waste-to-Energy Research

WTE has captured many investors' attention. However, many of the environmental and economic promises of these technologies are disputed or have yet to materialize. Philanthropic research capital could be used to both test and improve WTE technologies so that investors can make more informed decisions. Particularly interesting opportunities for research include:

- True emissions metrics for gasification, pyrolysis, and incineration. As many plants have not yet been built, this research is particularly timely to assess the claims offered by plant manufacturers and provide an objective evaluation of the environmental impacts of these technologies.
- Small-scale technologies: many current proposals require 50 or 100 TPD of waste or more. Pyrolysis alone can accommodate <5 TPD of plastic waste. Depolymerization, on the other hand, has considered minimum scales of 1,000 TPD of waste. This large scale presents two problems. First, it makes these technologies unfeasible in small island developing states (SIDS) environments or in smaller municipalities. Second, it discourages adoption of alternative materials and reduction in amount of waste generated as the facilities require a minimum amount of waste daily to operate properly.

## Supporting Higher-Risk, High-Impact Investments

There are promising opportunities for significant impact where the returns do not fully compensate investors for the risks. In these instances, where the impact is particularly outsized, it would be beneficial for philanthropists to step in and offer lower cost capital than traditional investors can accept. Either structured as Program Related Investments (PRIs, where somewhat lower return is expected), loan guarantees (which help other investors recover their money in the event of default), or other forms

of philanthropic support, concessionary capital can catalyze urgent investment that otherwise might not occur. One area that is a particular fit for these opportunities is in the informal waste sector, and there are many others across the plastics life cycle.

### **Informal waste management sector**

The informal waste management sector today is characterized by a largely disaggregated but highly efficient group of workers who sort through waste in search of high-value commodities. Working with a waste worker cooperative can provide an individual worker with better pay, better protections, better support and even better equipment and opportunities. These waste worker cooperatives have been successful when given the opportunity to expand their efforts, but often need additional funding and support to successfully grow. In addition to the opportunities for micro-finance and larger project loans outlined earlier, the informal waste sector and affiliated zero waste groups could expand their reaches with philanthropic support. Indeed, philanthropic support could help these groups get positioned to receive additional investment.

Examples of programs that could be funded through philanthropic support:

- Pilot studies for new zero waste strategies in low-income countries: building out demonstration projects that can show new and innovative archetypes for waste management that rely on the informal waste sector
- Education programs for waste separation, recycling and composting: these funds would allow zero waste groups to better work with their communities, helping divert a greater amount of waste from landfills and improving the waste pickers' ability to earn decent wages off of the waste stream

## Market-Altering Prizes

In 2004, the Ansari XPRIZE awarded a \$10 million prize to a winning team that was able to build a reliable, reusable, private spaceship that was capable of carrying three people 100 km above the Earth's surface.

[\[92\]](#) From this prize, an entire industry was born, and private space travel is expected to bring in \$1.6 billion before 2022.[\[93\]](#)

A prize of that size could catalyze similar development in search for better solutions to the ocean plastics problem. One area where this prize could be particularly effective is in catalyzing material design work to create the currently elusive bio-benign materials (including additives and adhesives) that have the potential to be cost- and performance-competitive at scale. A discovery like this would be a truly transformative development.



9





# Citizen Engagement

## Additional Lever #2: Citizen Engagement

**Raise public awareness, facilitate ocean-friendly purchasing decisions, and encourage citizens to make modest behavior changes**

Citizens globally can and must begin to make choices that can reduce the problem of ocean plastics. As individuals across the world make choices today that contribute directly to the ocean plastics problem, they also have significant power to stop the flow of plastic into the ocean.

Citizens have two main ways to affect change on ocean plastics: 1. change their purchasing choices, and 2. change their own behavior around plastic use and end-of-life waste management. Before they will do either of these things, however, they first have to understand and care about the problem.

For investors who are interested in the potential of new products and business models, as well as integrated waste management systems, efforts to inform and shape citizen behavior are of particular importance, as this is a key success factor for those investments. Investors who see a synergy with their projects in influencing citizen behavior to be more ocean-friendly may find willing partners in philanthropists, NGOs and even government.

## Raising Consumer Awareness Globally

Ocean plastics are still not a top-of-mind issue for most global citizens – even those for whom the problem is most visible. Companies, NGOs, and municipalities are working to raise awareness in culturally-appropriate ways of the importance of keeping plastic waste out of the ocean and helping citizens understand the best ways to help.

### **High-Income countries**

Some companies have taken actions to raise the profile of ocean plastics as a problem. Method created a special soap container out of reclaimed ocean plastic and produced a hang-tag with information about it for consumers. Adidas made a limited-run concept shoe out of plastic harvested from the ocean, and Parley and G Star created Raw for the Oceans, which resulted in ocean plastic jeans and other apparel. In high-income countries, these companies are raising awareness about the problem of plastic in the ocean.

Many NGOs, foundations and non-profit organizations are dedicated to raising awareness of and finding solutions to the problem of plastics in the ocean. The organizations with a focus in this area include Surfrider Foundation, Algalita, One World One Ocean, Plastic Soup Foundation, 5 Gyres, Story of Stuff, One More Generation, Ocean Conservancy, Oceans Unite,

Oceans 5 and many more. Their campaigns combine a variety of tactics from long-form documentary to social media engagement to research, advocacy, and activism.

Municipalities have conducted public education campaigns discouraging littering, promoting recycling, and promoting behaviors that reduce plastic waste, such as bringing reusable shopping bags and using a refillable water bottle.

Awareness is growing: a survey of millennials found that 61 percent identified “Pollution from run-off, oil spills and plastic garbage” as a threat to the ocean, making it the most cited threat.[\[94\]](#)

But too many people globally still are not motivated to address this issue. Continued work to raise citizen awareness is needed.

### **Low- and middle-income countries**

Additional work is needed to raise awareness among residents of low- and middle-income countries about the damaging effect that plastic waste can have on the marine environment. In many of these countries, littering, open dumping, and waste burning are culturally acceptable. Ending these practices will require engagement with millions of individual households, working in tandem with efforts to improve waste management services to these households.

Citizens of both high- and low-income countries can also participate in beach and waterway cleanups. These actions help to both remove an immediate source of litter from the ocean as well as raise awareness about the impacts that plastic waste can have on the marine environment.

### **Citizen Strategies for Stopping Plastics From Entering the Ocean**

The citizen actions that one can take will vary based on location. With different levels of education, awareness, and purchasing ability, the expectations for action vary.

For consumers in high-income countries, purchasing decisions can mean choosing products with biodegradable packaging or a high percentage of recycled content, using reusable packaging, buying products made from recycled plastic or other non-plastic materials, or participating in the sharing economy.

In lower-income countries, consumers may not have the luxury of choosing products based on their plastic content, but where possible these individuals should focus on using reusable packaging or buying products without unnecessary packaging.

As incomes rise in Southeast Asian, African, and Latin American countries, these households may expand their waste generation, as has been the case in high-income countries. As their consumption grows, it is important that these citizens also learn the importance of ocean-friendly purchasing decisions.

Small sachets, for example, are commonly used to hold small amounts of soap and shampoo. These products are difficult and costly to recycle and represent a growing problem for the ocean. Households with greater purchasing power should be educated on the benefits of purchasing household products in bulk, as they can be reused or captured and recycled more easily.

Everywhere, consumers need more and better information about products and packaging in order to make more values-aligned choices. For example, the Dolphin-Safe Tuna label was developed in response to consumer confusion and concern about tuna fishing practices. Once consumers had the information, their choice was clear: 99 percent reduction in dolphin deaths related to tuna fishing.[\[95\]](#) Certification efforts such as the Marine Stewardship Council (MSC) designation for fish, and Forest Stewardship Council (FSC) designation for wood and paper, have enabled consumers to be much more informed about the choices they are supporting.



Along these lines, there are efforts underway to bring greater transparency and standardization to plastics labeling to enable clearer market signals and improved consumer choices. The Plastic Disclosure Project, modeled after the Carbon Disclosure Project, tracks how much plastic goes into certain products and the way they are packaged.



# 10





# Government Actions

## Additional Lever #3: Government Actions

### Use policy, international action, and government capital expenditures to accelerate change

Governments are critical actors in the fight against ocean plastics. They can use policy to create the conditions for successful action from material development through the waste management system, engage internationally to support global collective action, and they can fund efforts that stop the flow of plastic waste into the ocean.

In many cases, policies can impact the viability and ultimate success of an investment, either directly or indirectly. Interested investors would be wise to carefully consider the policy landscape relevant to a particular investment opportunity.

Complete governmental recommendations are beyond the scope of this report. This section provides a brief overview of policies and other government opportunities relevant to potential solutions across the value chain. A comprehensive policy landscape and analysis is needed to inform future policy discussions and recommendations.

### Relevant Policies to Consider

Individual countries, states and municipalities have a range of possible policy intervention opportunities

across the value chain. This section provides an overview of potential policy objectives and then some examples of how these are being brought to life around the world today.

While the problem of ocean plastics has not been politicized and typically draws bipartisan support, not all policies with potential to impact ocean plastics will be so lucky. Policies such as chemical transparency, plastic product bans and EPR programs have drawn heavy opposition when proposed. The solutions likely to be most politically feasible in the United States over the next several years are supporting innovation and a marketplace for new materials, as well as technical assistance programs that support the development of stronger waste management systems in countries where they are needed. There may also be support for ensuring that ocean plastics are addressed in relevant upcoming treaty or trade negotiations. Other countries face distinct political climates within which each of these policy approaches may be either welcomed or shunned.

### **Require Transparency in the Use of Additives and Substances of Concern**

One significant challenge to better management of post-use plastics is the lack of transparency about what materials and additives are in certain plastics that may impact how they can be safely reused or repurposed. Existing regulations that allow for the transparent disclosure of key chemicals must be more consistently enforced and new regulation that goes

further is needed. A growing number of companies are making voluntary disclosures of chemical usage in consumer-facing industries, such as personal care products, household cleaning products, apparel manufacturing and retail, which could provide greater motivation to chemical companies to do the same.

### Support New Material Development

New material development, especially at very early stages of research, may be seen as a public good, and government funding for basic scientific research on materials can accelerate progress toward critical discoveries. At later stages of the material development process, ensuring that there is a well-functioning marketplace for new materials is critical to

successful commercialization and scaling. Policy can be an important enabler in this area.

### Prohibit Excessive Packaging

- **British regulations on excess packaging** first took effect in 2003 in an effort to reduce waste, particularly for items that cannot be recycled and go into a landfill. The law, which is still in force and is kept updated, requires packaging volume and weight to be the minimum amount to maintain the necessary levels of safety, hygiene and acceptance for the packed product and for the consumer. The packaging must also be manufactured so as to permit reuse or recovery in accordance with specific requirements, and noxious or hazardous

Table 7

Potential Policy Objectives by Value Chain Step

Value Chain Step	Potential Policy Objective
<b>Material Engineering and Design</b>	<ul style="list-style-type: none"> <li>• <b>Require transparency in use of additives and Substances of Concern</b> to facilitate recycling and ensure safe chemical management</li> <li>• <b>Support new material development</b> through the creation of a marketplace for new materials and provide incentives and funding for innovative materials research</li> </ul>
<b>Product and Business Design</b>	<ul style="list-style-type: none"> <li>• <b>Prohibit excessive packaging</b> to reduce packaging waste and provide a level playing field for marketing via packaging</li> <li>• <b>Provide incentives and support for the shift toward a circular economy</b></li> </ul>
<b>Consumer Use and Behavior</b>	<ul style="list-style-type: none"> <li>• <b>Ban certain plastic products or applications</b> such as plastic grocery bags, single-use plastic utensils, and microbeads in personal care products</li> </ul>
<b>Collection</b>	<ul style="list-style-type: none"> <li>• <b>Implement EPR programs</b> to require producers to contribute to the cost of end-of-life management for their products</li> <li>• <b>Create Technical Assistance support programs</b> that enable technical experts to be “loaned” to countries that have a need for waste management system expertise</li> </ul>
<b>Recycling and Reuse</b>	<ul style="list-style-type: none"> <li>• <b>Create a Thriving Marketplace for Recycled Content</b> through recycled content requirements for certain materials, virgin resource taxes, government procurement policies or other standard-setting policies</li> </ul>
<b>Conversion and Disposal</b>	<ul style="list-style-type: none"> <li>• <b>Consider policies impacting the use of WTE technologies</b></li> <li>• <b>Use landfill bans (carefully) to promote composting and recycling</b>, and to direct hazardous items toward better end-of-life options</li> </ul>



substances in packaging must be minimized in emissions, ash or leachate from incineration or landfill.[\[96\]](#)

- **The Courtald Commitments** were a series of voluntary commitments for collaborative action across the U.K. Phase 1 achieved no growth in packaging waste and Phase 2 reduced grocery packaging by weight by 10.7 percent, with traditional grocery product and packaging waste in the grocery supply chain reduced by 7.4 percent.[\[97, 98\]](#)

- **EU Directive 94/62/EC** in December of 1994 aimed to harmonize disparate country regulations and provide direction on preventing the production of packaging waste as a first priority, with secondary goals of reusing and recycling packaging, recovering packaging waste and reducing the final disposal of such waste.[\[99\]](#)
- **South Korea, Australia, New Zealand, Canada, and Japan** have limitations on how much space can be empty inside of a package both to minimize excess packaging and to prevent misleading consumers about how much product is in a package.[\[100\]](#)
- **Many countries including the EU and South Korea** require some companies, based on size or volume of production, to submit a detailed packaging reduction plan that includes long-term goals for the reduction of packaging material.[\[100\]](#)

### ***Provide Incentives and Support to Shift Toward a Circular Economy***

In a circular economy, materials continue circulating at their highest and best use as long as possible, maximizing the value for each material and for society as a whole. While circular economy businesses are expected to thrive economically, the transition from the linear economy to the circular economy holds uncertainties and costs, and businesses may require additional support during this process.

One example of a comprehensive set of policy initiatives across the life cycle to support this shift is the European Union's Circular Economy package. This groundbreaking policy package was adopted in 2015 and aims to provide a mix of incentives and targets to shift the EU's economy to be more circular. This

includes targets on recycling of municipal waste as well as packaging waste specifically (coupled with new restrictions on landfilling), economic incentives for producers to adopt circular-economy-friendly design and to support the recovery and recycling of their products, and targeted measures to increase "industrial symbiosis" where one company's by-product becomes another's raw material. The package also calls for a comprehensive and integrated EU strategy for plastics and recognizes the need for a bold target of reducing marine litter by 30 percent by 2020.[\[101\]](#)

### ***Ban certain plastic products or applications***

- **Plastic Silverware, Plates and Cups:** France has put in place a policy that requires plastic plates, cups and silverware to be made from bio-based sources and be compostable. Producers of these products have until 2020 to make the transition. [\[102\]](#)
- **Plastic microbeads:** By the end of 2017, it will be illegal in the U.S. and the U.K. to sell personal care products containing plastic microbeads. [\[103, 104\]](#) Organizations such as Greenpeace and The Story of Stuff waged intense campaigns engaging citizens to lobby their lawmakers to pass these bills, and they are anticipated to use these two big victories to continue advocating to get other countries to follow suit.[\[105\]](#) While this is an undeniable success, more work is needed as chemical companies continue to develop products that use microplastics but that would not be regulated under the current microbead bans. For example, the Dow Chemical Company has created "sunspheres," which are hollow spherical plastic nanoparticles that can increase the effectiveness of sunscreen without adding additional chemicals. [\[106\]](#) Because they are not intended to be washed off they would not be included in the microbead ban. Open questions remain about the potential for impacts on human health of exposure to plastic nanoparticles.
- **Plastic bags:** Countries such as France, Rwanda and Bangladesh, and states or cities within the U.S., U.K., Chile, India, Mexico, Philippines, Mali, and Australia have banned the use of plastic bags completely, to varying degrees of success. Other



locales such as Ireland, Italy, and Belgium tax plastic bags, and other places such as South Africa have placed a fee on plastic bags to discourage their use.

- **Expanded Polystyrene Foam:** At least 10 cities in the U.S. have banned Expanded Polystyrene Foam, often called Styrofoam for the Dow product made from this material, due to its negative impact on the environment.

### ***Implement Extended Producer Responsibility***

With EPR, the producer of a product or package bears some or all of the responsibility for the cost and assurance of its appropriate disposal at end of life. Many countries have EPR regulations on waste items that pose disposal hazards, such as electronics, batteries, paint and pesticides, but some countries have gone further to include packaging such as bottles and products that have residual value either for re-use or for their materials.

EPR can kick-start a variety of cottage industries around recycling, and it is a market-oriented solution that finds the lowest cost of compliance to solve a global problem.

*Notable examples of Extended Producer Responsibilities policies are:*

- **Norway:** Norway has an environmental tax scheme for any company selling beverages in PET bottles. Companies who want to sell beverages in PET bottles must show that 95 percent of those bottles are not only captured, but recycled or used for energy recovery. For any portion under 95 percent that is not converted, the company manufacturing the product will pay 500,000 NOK (~\$90,000) per metric ton of PET. This EPR framework encouraged the formation of several companies that provide the collection/recapture and recycling PET bottles. One of these companies, Infinitum, provides PET bottle-to-bottle recycling in Norway. It captures bottles via reverse vending machines in grocery stores that instantly return the deposit to the consumer upon return of the bottle.
- **The EU** requires member states to ensure that >60

percent packaging waste by weight is recovered or incinerated and that 55-80 percent is recycled. The Green Dot, for example, indicates on consumer packaging if the product's manufacturer supports the end of life collecting and processing of the product or package. A licensing fee paid by the manufacturer aims to incentivize reduced packaging waste and sustainable package design. There have been concerns that these EPR policies lead to greater WTE. If that is not the desired outcome for whatever reason, steps should be taken to reduce the likelihood of WTE as the ultimate end point.

- **Japan** implemented the Home Appliance Recycling Act both to ensure proper disposal of hazardous waste as well as to ensure the effective use of recyclable materials, including the iron, aluminum, copper and glass contained in home appliances.
- **South Korea's** Waste Charge System, introduced in 1993, imposes a fee on manufacturers and importers for products that are not easy to recycle or that contain hazardous materials which could be problematic in the waste system. The fees collected go toward purchasing recycled materials, supporting recycling businesses and waste disposal facilities, and research and development.

[\[107\]](#)

### ***Create Technical Assistance Support Programs***

One way that high-income countries may be able to support lower-income countries struggling with waste management is through a technical assistance program. It is common for governments to "loan" technical experts in various specialties to provide hands-on expertise where there may not be enough local experts to meet local needs. Additionally, where successful strategies have been tested in other lower-income countries, methods should be shared globally. This can be a relatively low cost but high impact intervention.

### ***Create a Thriving Marketplace for Recycled Content***

There is an opportunity to use various policy levers to stoke strong demand for recycled materials, creating more pull to draw recyclable materials into the system

and increase the amount of recycled material being used. With low oil prices putting recycled content at a competitive disadvantage, providing targeted short-term support for recycled content can help bridge to when oil prices rise again.

- **Require a minimum level of recycled content:** States such as California, Oregon and Wisconsin have minimum requirements for recycled content for some kinds of plastic containers, as well as some other kinds of packaging (for example, glass bottles, expanded polystyrene loose-fill packaging, plastic garbage bags) but in general there are very few requirements of this kind today.[\[108\]](#)
- **Require recyclability:** California has a number of bans and ordinances at the local level that target non-recyclable and/or non-compostable food service packaging, expanded polystyrene packaging and landfill bans on recyclables.[\[108\]](#)
- **Procurement policies:** Some governments and universities have purchasing policies that favor or require purchase of products with recycled content.
- **Virgin resource taxes,** not implemented anywhere currently, would create a financial incentive to choose recycled materials over virgin ones.

### ***Consider policies impacting the use of Waste-to-Energy technologies***

WTE facilities typically require a specific set of policies to be in place to enable them to be considered as solutions for a particular locale. The implementation, or not, of these policies significantly influences whether WTE facilities can be built.

Policies that impact the viability of a WTE facility include:

- **Feed-in tariffs:** WTE facilities are not typically economically viable without a subsidy, typically provided as a feed-in tariff for the electricity being provided to the grid. There has been debate about whether waste should qualify for feed-in tariff support. Feed-in tariffs have traditionally been set up with language that defines eligible energy sources as “renewable.” This has led some locales to categorize waste streams as renewable, others

have explicitly included municipal solid waste as an eligible source of energy, and still others have explicitly excluded it.

- **Tipping fees:** Tipping fees are another source of revenue, and sometimes government subsidy, for waste management companies. Traditionally, tipping fees have been paid to landfills or others who take waste from those who collect it for various end-of-life treatments. The eligibility of a WTE facility to receive tipping fees impacts the financial viability of the facility and therefore its likelihood of being built.
- **Environmental regulation:** The level of environmental protections and the standards to which facilities are held, as well as the level of enforcement of those protections, significantly impact the cost of WTE facilities. Clearly WTE facilities should meet the highest environmental standards possible.
- **Transport of waste:** One factor that can impact the financial and operational viability of WTE facilities is access to consistent volumes of waste. Depending on the location of a facility, it may rely on waste streams across state or national borders or through restricted methods of transportation. Laws governing transport of waste can significantly impact the viability of a WTE facility.

### **Use landfill bans (carefully) to promote composting and recycling**

States and countries place rules on what can and cannot be landfilled, requiring alternative disposal for those items. Banned items often include potential hazards, such as paint, lead-acid batteries and untreated medical waste, but they can also include items for which the landfill is not the optimal final destination, such as yard waste and recyclable items.

While landfill bans can be an effective part of a strategy to ensure better end-of-life treatment of waste, they can also lead to unintended consequences, such as sending more waste than intended to WTE facilities or shipping hazardous wastes to other countries not prepared to deal with them appropriately.

A few examples of current landfill bans:

- In the United States, 19 states have banned yard waste from landfills and in many cases waste management companies collect it separately for composting.[\[109\]](#)
- The European Union has banned the landfilling of recyclable items effective starting in 2025. Stronger recycling systems are being put in place in the meantime to provide a path for these recyclables. [\[110\]](#)
- Nova Scotia, Canada, banned all organic material from landfills, including yard waste, food scraps and soiled paper.[\[111\]](#)

## International Agreements

International cooperation can also lead to lasting change. With a continued focus on the issue from both the G7 and the G20, an opportunity for international cooperation on the problem is likely over the next several years.

### **Multilateral Approaches**

Ocean plastics, and marine litter from all sources, have gotten attention in multilateral treaties and trade agreements. A good summary of these agreements is contained in [\[4\]](#) Marine litter has been addressed directly or indirectly in agreements such as the United Nations Convention on the Law of the Sea (UNCLOS), the International Convention for the Prevention of Pollution from Ships (MARPOL 73/78), the London Convention, the Global Program of Action (GPA) which houses the Global Partnership on Marine Litter (GPML), and the UNEP's Honolulu Strategy. The United Nations Environment Assembly (UNEA) has adopted resolutions to address marine litter, and Regional Seas Conventions and Action Plans also play a role in marine protection and facilitating cooperation to ensure it. The FAO Code of Conduct for Responsible Fisheries is also relevant through its language on responsible fishing and management of fishing gear.

Multilateral approaches also come into play through agreements for the protection of biodiversity and migratory animals, such as The Convention on the

Conservation of Migratory Species of Wild Animals, the UN Convention on Biological Diversity, and The International Whaling Commission (IWC).

### **2030 Agenda and Sustainable Development Goals**

The 2030 Agenda and the Sustainable Development Goals provide a framework of 17 goals to guide individual and collective work on sustainably improving life on this planet. The goals most directly related to ocean plastics briefly are (compiled from [\[4\]](#)):

- **Goal 6**, Ensure access to water and sanitation for all.
- **Goal 12**, Ensure sustainable consumption and production patterns.
- **Goal 14**, Conserve and sustainably use the ocean, seas and marine resources.

Other goals are also relevant:

- **Goal 7**, Ensure access to affordable, reliable, sustainable and modern energy for all, touches on the potential for WTE to provide a reliable source of energy, especially in places where this is most needed. This goal assumes the implementation of environmental controls.
- **Goal 8**, Promote inclusive and sustainable economic growth, employment and decent work for all, relates to the work that can be done to improve the livelihoods of the workers of the informal waste sector, many of whom currently do not have 'decent' work.
- **Goal 13**, Take urgent action to combat climate change and its impacts, is addressed both through improved material choices which reduce the GHG footprint of materials and through reduction in GHG emissions from poorly managed waste.

It is clear that addressing the issue of ocean plastics has the potential for significant and broad progress related to many of the Sustainable Development Goals,

further amplifying the importance of this work. Those acting to address the challenge of ocean plastics may find it helpful to reference the relevant Sustainable Development Goals to further reinforce the scope and scale of impact.

## Capital Spending and Last Chance Capture

Governments are also responsible for large capital budgets that can be used to finance non-economic but beneficial infrastructure that can help solve the problem. Investments in waste management infrastructure are discussed earlier in this report. This section looks at “last chance” capture for plastic and other waste that has escaped primary collection.

Rivers and other waterways flowing with plastic waste on its way to the ocean are sometimes called the “horizontal smokestacks” of marine debris. While cleaning plastic out of the ocean is expensive and difficult, catching it just before it goes in can be lower cost and simpler.

These litter catchment devices are unable to generate sufficient economic returns, and must be paid for by local governments as a public amenity.

Various devices have been designed that capture plastic waste in rivers so it can be removed before getting into the ocean. For rivers, there is a current-powered water wheel that collects plastic and other waste as it flows downriver. There is one in Baltimore and the designer, Clearwater Mills, has plans to do so in other U.S. cities. These water wheels beautify rivers, but typically do not collect enough plastic to generate sufficient revenues. For this reason, they have only looked at working with U.S. cities that are able to pay for the water wheel, as they do any municipal improvement.

Other small scale catchment technologies, such as sea bins or filters in sewers, could be used to catch ocean-bound plastic right before it hits the ocean. The Bandalong Litter Trap is currently used in parts of Australia, Asia and the U.S. The city of Waycross, Georgia, has removed more than 349 cubic yards of litter in 3.5 years of use to date. Washington D.C. was the first city in the Western hemisphere to adopt it.



# Additional Research Needed

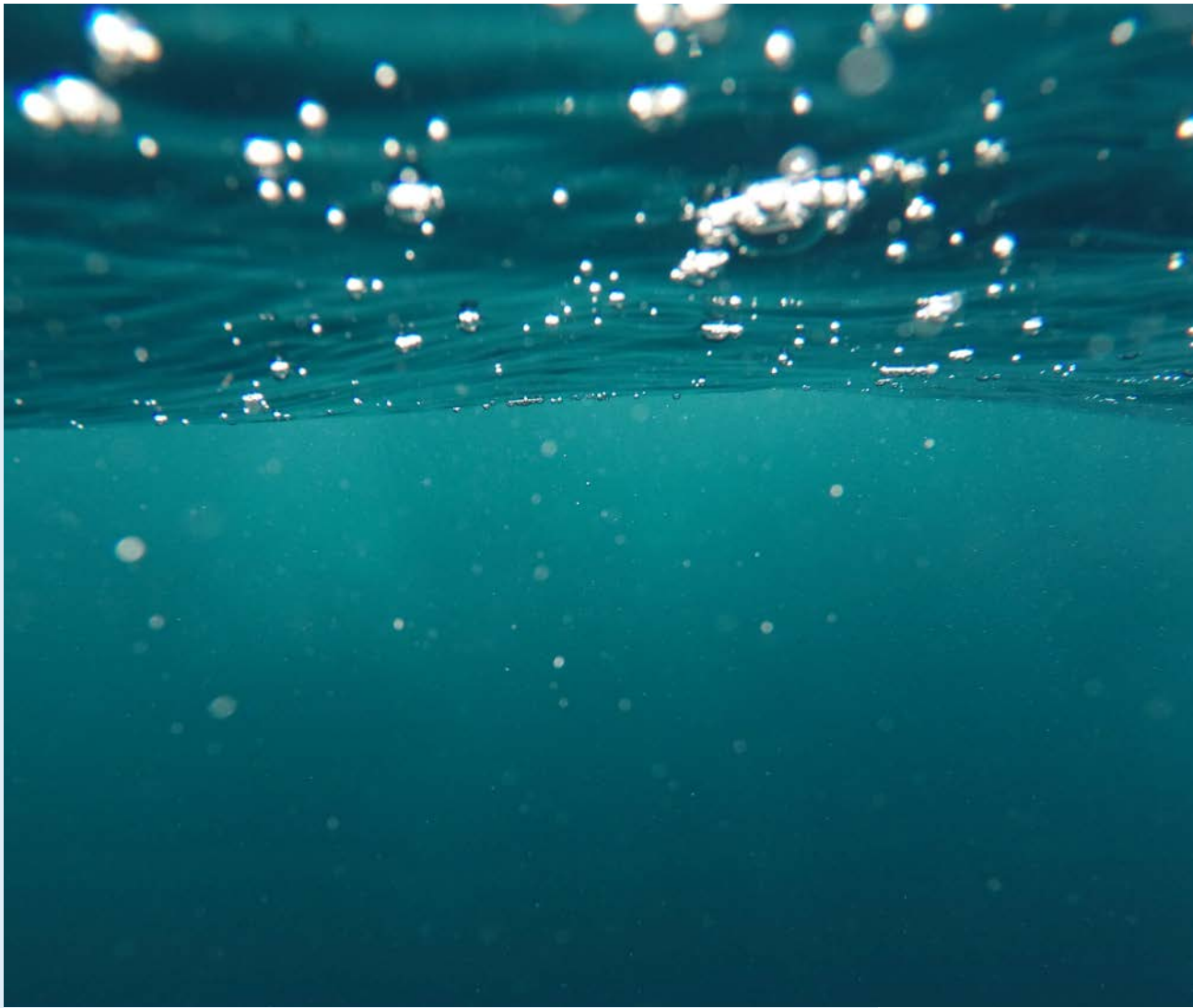



While enough is known today to take strategic action, there remain gaps in data and understanding of the causes and impacts of ocean plastics.

The research agenda below was developed for the Trash Free Seas Alliance by 14 scientists, all of whom work on some aspect of the ocean plastic problem, including engineers, waste management specialists, marine biologists, and oceanographers. Their collective perspective on where research should be focused is provided here:

### **Sources**

- Undertake fine-scale, quantitative assessments of the terrestrial and maritime sources of plastic waste to the ocean, and the fluxes of different plastic materials between marine reservoirs.
- Develop a better understanding of the mechanisms by which materials escape waste management and how they move to the ocean, including the role of rivers and watersheds as conduits from land to the sea.

### **Distribution**

- Develop robust and efficient technologies to detect and quantify plastic debris globally on coastlines, at the sea surface and on the seafloor. This will require determining the size-frequency distribution of plastic debris from nanoparticles to large debris such as derelict fishing gear and debris from natural disasters.
- Identify “hot spots” of plastics accumulation that could have negative impacts on marine life or the ocean ecosystem, or that might be target areas for clean-up activities.
- Resolve the apparent disparity between the large yearly input of plastics to the ocean and the relatively small amount that can be accounted for at the ocean surface.

### **Fates**

- Perform quantitative assessments of the fates of plastics in the ocean from sources to sinks, with a focus on transformations within and pathways between coastal regions, the deep sea and the marine biota.
- Develop a mechanistic understanding of the means by which large plastic items degrade into microplastics, including the relative importance of physical and biological processes and the time scales of breakdown.

### **Impacts**

- Apply a risk assessment framework (integrating both exposure and impact) to quantify the risk of plastics to marine wildlife and human health, now and in the future.
- Measure the exposure of farmed and wild seafood species to plastics in the marine environment.
- Quantify the body burden, individual fitness, and population consequences of toxicants in marine wildlife from the ingestion of plastics versus other routes of exposure.



# Conclusion



The time to act on ocean plastics is **now**. This investment roadmap provides opportunities for diverse investors to get involved: there are opportunities across the plastics value chain, across asset classes, at different levels, and with different time horizons that meet a broad range of interests and requirements. In addition to being attractive, strategic investments, these opportunities hold tremendous potential for impact on a problem with global implications for the environment and for people. With swift action to invest in these many solutions, the amount of plastic waste entering the ocean can be slowed from a torrent to a trickle.



# References

1. Jambeck, J.R., et al., Plastic waste inputs from land into the ocean. *Science*, 2015. 347(6223): p. 768-771.
2. Valuing Plastics: The Business Case for Measuring, Managing and Disclosing Plastic Use in the Consumer Goods Industry. 2014, United Nations Environment Programme.
3. Microplastics in the ocean: A global assessment. 2015, United Nations Joint Group of Experts on the Scientific Aspects of Marine Pollution (GESAMP), Working Group 40.
4. UNEP, Marine plastic debris and microplastics – Global lessons and research to inspire action and guide policy change. United Nations Environment Programme, 2016.
5. Rochman, C.M., Browne, M.A., Underwood, A.J., van Franeker, J.A., Amaral-Zettler, L.A., Thompson, R.C., Perceived and demonstrated ecological impacts of marine debris. *Ecology*, 2016. 97(2): p. 302-312.
6. Hardesty, B.D., T.P. Good, and C. Wilcox, Novel methods, new results and science-based solutions to tackle marine debris impacts on wildlife. *Ocean & Coastal Management*, 2015. 115: p. 4-9.
7. Bergmann, M. and M. Klages, Increase of litter at the Arctic deep-sea observatory HAUSGARTEN. *Marine Pollution Bulletin*, 2012. 64(12): p. 2734-2741.
8. Ocean Conservancy. Top 10 Items Found. 2015 January 23, 2017]; Available from: <http://www.oceanconservancy.org/our-work/international-coastal-cleanup/top-10-items-found-1.html>.
9. Plastics – the Facts 2016. 2016, Plastics Europe.
10. van Sebille, E., et al., A global inventory of small floating plastic debris. *Environmental Research Letters*, 2015. 10(12): p. 124006.
11. Eriksen, M., et al., Plastic Pollution in the World's Oceans: More than 5 Trillion Plastic Pieces Weighing over 250,000 Tons Afloat at Sea. *PLOS ONE*, 2014. 9(12): p. e111913.
12. S.C. Gall, R.C., Thompson, The impact of debris on marine life. *Marine Pollution Bulletin*, 2015. 92(1-2): p. 170-179.
13. Rochman, C., The Complex Mixture, Fate and Toxicity of Chemicals Associated with Plastic Debris in the Marine Environment, in *Marine Anthropogenic Litter*, L.G. Melanie Bergmann, Michael Klages, Editor. 2015, Springer.
14. Good, T.P., et al., Derelict fishing nets in Puget Sound and the Northwest Straits: Patterns and threats to marine fauna. *Marine Pollution Bulletin*, 2010. 60(1): p. 39-50.
15. Wilcox, C., et al., Using expert elicitation to estimate the impacts of plastic pollution on marine wildlife. *Marine Policy*, 2016. 65: p. 107-114.
16. Chris Leggett, N.S., Mark Curry and Ryan Bailey, , Assessing the Economic Benefits of Reductions in Marine Debris: A Pilot Study of Beach Recreation in Orange County California. 2014, Industrial Economics Inc. for the NOAA Marine Debris Program.
17. Global Waste Management Outlook. 2015, United Nations Environment Programme.
18. Ocean Conservancy, Stemming the Tide: Land-based strategies for a plastic-free ocean. Ocean Conservancy, Washington, DC, 2015.
19. Sherrington, C., et al., Study to support the development of measures to combat a range of marine litter sources. London: Report for European Commission DG Environment, 2016.
20. GRID-Arendal, U.a., Marine Litter Vital Graphics. United Nations Environment Programme and GRID-Arendal, 2016.



21. Macfadyen, G., T. Huntington, and R. Cappell, Abandoned, lost or otherwise discarded fishing gear. 2009: Food and Agriculture Organization of the United Nations (FAO).
22. Zettler, E.R., T.J. Mincer, and L.A. Amaral-Zettler, Life in the "Plastisphere": Microbial Communities on Plastic Marine Debris. *Environmental Science & Technology*, 2013. 47(13): p. 7137-7146.
23. Jang, Y.C., et al., Estimation of lost tourism revenue in Geoje Island from the 2011 marine debris pollution event in South Korea. *Marine Pollution Bulletin*, 2014. 81(1): p. 49-54.
24. Scheld, A.M., D.M. Bilkovic, and K.J. Havens, The Dilemma of Derelict Gear. *Scientific Reports*, 2016. 6: p. 19671.
25. McIlgorm, A., H. Campbell, and M. Rule, Understanding the economic benefits and costs of controlling marine debris in the APEC region (MRC 02/2007). A report to the Asia-Pacific Economic Cooperation Marine Resource Conservation Working Group by the National Marine Science Centre (University of New England and Southern Cross University), Coffs Harbour, NSW, Australia, December, 2008.
26. US Coast Guard. 2015 Recreational Boating Statistics. COMDTPUB P16754.29 2016 [cited 2017 January 26]; Available from: <http://uscgboating.org/library/accident-statistics/Recreational-Boating-Statistics-2015.pdf>.
27. Lerpiniere D., W.D.C., Velis C.A., Evans, B., Voss, H., Moodley K., Review of International Development Cooperation in Solid Waste Management. Report prepared by University of Leeds and formatted by D-Waste on behalf of ISWA Globalisation and Waste Management Task Force, 2014. International Solid Waste Association.
28. Ocean Conservancy, The Next Wave. 2017.
29. Mahdi, W. and A. DiPaola, Aramco, Sabic One Step Closer to Turning Oil Into Chemicals. 2015, Bloomberg, <http://www.bloomberg.com/news/articles/2016-06-28/saudi-aramco-sabic-one-step-closer-to-turn-oil-into-chemicals>.
30. Gourmelon, G., Global Plastic Production Rises, Recycling Lags. New Worldwatch Institute analysis explores trends in global plastic consumption and recycling. <http://www.worldwatch.org>, 2015.
31. Endocrine Disruptors. Health and Education 2016 January 5, 2017 [cited 2016 2016, Nov. 18]; Available from: <https://www.niehs.nih.gov/health/topics/agents/endocrine/>.
32. Waterfront Partnership of Baltimore. Mr. Trash Wheel. 2016 [cited 2017 January 12]; Available from: <http://baltimorewaterfront.com/healthy-harbor/water-wheel/>.
33. Peplow, M. The plastics revolution: how chemists are pushing polymers to new limits. 2016 August 17, 2016; Available from: <http://www.nature.com/news/the-plastics-revolution-how-chemists-are-pushing-polymers-to-new-limits-1.20433>.
34. World Economic Forum and Ellen MacArthur Foundation. The new plastics economy: rethinking the future of plastics. 2016; Available from: <https://www.ellenmacarthurfoundation.org/publications/the-new-plastics-economy-rethinking-the-future-of-plastics>.
35. Tejonmayam, U., IITians offer biodegradable alternative to plastic sachets, in The Times of India. 2016, <http://timesofindia.indiatimes.com/city/chennai/IITians-offer-biodegradable-alternative-to-plastic-sachets/articleshow/51064929.cms>.
36. Fisher, G., Lego says its plastic pieces will be made with sustainable material by 2030, in Quartz. 2015, <http://qz.com/437264/lego-says-its-plastic-pieces-will-be-made-with-sustainable-material-by-2030/>.
37. United States Environmental Protection Agency, Advancing Sustainable Materials Management: Facts and Figures 2014. 2016, US EPA Washington, DC.
38. Gardiner, B., The Side Effects of Consumption, in The New York Times. 2014, <http://www.nytimes.com/2014/11/20/business/energy-environment/packaging-environment.html>



39. Azzato, M. Walmart Hits Packaging Reduction Goal, Sets New Objectives. 2013 November 18, 2016]; Available from: <http://www.greenretaildecisions.com/news/2013/11/14/walmart-hits-packaging-reduction-goal-sets-new-objectives->.
40. Ruiz-Grossman, S. Genius Solid Shampoos Use No Plastic Packaging By Leaving Out Water. The Huffington Post 2016 [cited 2016 November 18]; Available from: <http://www.greenretaildecisions.com/news/2013/11/14/walmart-hits-packaging-reduction-goal-sets-new-objectives->.
41. Edwards, C. and J.M. Fry, Life cycle assessment of supermarket carrier bags. Environment Agency, Horizon House, Deanery Road, Bristol, BS1 5AH, 2011.
42. Gilman, E., Status of international monitoring and management of abandoned, lost and discarded fishing gear and ghost fishing. *Marine Policy*, 2015. 60: p. 225-239.
43. Hoornweg, D. and P. Bhada-Tata, What a waste: a global review of solid waste management. *Urban development series knowledge papers*, 2012. 15: p. 1-98.
44. Muggeridge, P. Which countries produce the most waste? 2015 November 18, 2016]; Available from: <https://www.weforum.org/agenda/2015/08/which-countries-produce-the-most-waste/>.
45. US Environmental Protection Agency. Pollution Prevention (P2) and Toxics Release Inventory (TRI). [cited 2017 January 26]; Available from: <https://www.epa.gov/toxics-release-inventory-tri-program/pollution-prevention-p2-and-tri>.
46. Reprinted from *Resources, Conservation and Recycling*, 54(12), Kuczenski, B. and R. Geyer, Material flow analysis of polyethylene terephthalate in the US, 1996–2007, Pages 1161-1169, Copyright 2010, with permission from Elsevier.
47. Ellen MacArthur Foundation SUN and McKinsey Center for Business and Environment. Drawing from Braungart & McDonough Cradle to Cradle (C2C) [cited 2017 January 23]; Available from: <https://www.ellenmacarthurfoundation.org/circular-economy/interactive-diagram>.
48. Zaman, A.U.L., S., Challenges and Opportunities in Transforming a City into a “Zero Waste City”. *Challenges*, 2011. 2: p. 73-93.
49. Rogerson, C.M., The waste sector and informal entrepreneurship in developing world cities. *Urban Forum*, 2001. 12(2): p. 247-259.
50. Schiller, B. How Smart Cans are Making Garbage Pickup Cheaper and Less Smelly. 2016 November 18, 2016]; Available from: <https://www.fastcoexist.com/3059163/how-smart-bins-are-making-garbage-pickup-cheaper-and-less-smelly>.
51. Stern, M.J. A Little Guilt, a Lot of Energy Savings. 2013 March [cited 2017 January 23]; Available from: [http://www.slate.com/articles/technology/the\\_efficient\\_planet/2013/03/opower\\_using\\_smiley\\_faces\\_and\\_peer\\_pressure\\_to\\_save\\_the\\_planet.html](http://www.slate.com/articles/technology/the_efficient_planet/2013/03/opower_using_smiley_faces_and_peer_pressure_to_save_the_planet.html).
52. In Taiwan, trash disposal is a classical affair. *Mother Nature Network* Hickman, Matt [cited 2016 November 18]; Available from: <http://www.mnn.com/lifestyle/recycling/blogs/in-taiwan-trash-disposal-is-a-classical-affair>.
53. Froehlich, J., L. Findlater, and J. Landay. The design of eco-feedback technology. in *Proceedings of the SIGCHI Conference on Human Factors in Computing Systems*. 2010. ACM.
54. Mozo-Reyes, E., et al., Will they recycle? Design and implementation of eco-feedback technology to promote on-the-go recycling in a university environment. *Resources, Conservation and Recycling*, 2016. 114: p. 72-79.
55. Burke, W., *Organization Change: Theory and Practice*. Third ed. 2011, CA: Sage Publications.
56. Letuya, S.N., TakaTaka Solutions, How innovation in recycling saves water and lives, in *Grand Challenges Canada*. 2015.

57. Minnesota Pollution Control Agency, Increasing recycling of beverage containers in Minnesota: Recommendations for a statewide recycling refund program 2014.
58. González-Torre, P.L. and B. Adenso-Díaz, Influence of distance on the motivation and frequency of household recycling. *Waste Management*, 2005. 25(1): p. 15-23.
59. Kessler Consulting, I., Innovative Waste Reduction & Recycling Grant, MRFin Our Way to Diversion: Capturing the Commercial Waste Stream, Florida Department of Environmental Protection, Editor. 2009, Pinellas County.
60. Lakhan, C., A Comparison of Single and Multi-Stream Recycling Systems in Ontario, Canada. *Resources*, 2015. 4(2): p. 384.
61. Smith, K. 2015 Paper & Plastics Recycling Conference: Understanding the drivers of mixed-waste processing. 2015; Available from: <http://www.recyclingtoday.com/article/paper-and-plastics-recycling-conference-2015-mixed-waste-processing/>.
62. Waste and Resources Action Programme, MRFs Comparison of efficiency and quality. 2006.
63. Recommunity. MRF of the Month. 2012 [cited 2017 January 23]; Available from: <http://www.recommunity.com/wp-content/uploads/2012/05/MRF-Beacon.pdf>.
64. Medina, M., The informal recycling sector in developing countries: organizing waste pickers to enhance their impact. 2008.
65. Rouse, J.R., Seeking common ground for people: Livelihoods, governance and waste. *Habitat International*, 2006. 30(4): p. 741-753.
66. Wilson, D.C., et al., Building recycling rates through the informal sector. *Waste Management*, 2009. 29(2): p. 629-635.
67. Linzner, R. and S. Salhofer, Municipal solid waste recycling and the significance of informal sector in urban China. *Waste Management & Research*, 2014. 32(9): p. 896-907.
68. Gupta, S.K., Integrating the informal sector: Combing strengths to improve waste management, in *Waste*. World Bank Group.
69. Madsen, C.A., Feminizing waste: waste-picking as an empowerment opportunity for women and children in impoverished communities. *Colo. J. Int'l Envtl. L. & Pol'y*, 2005. 17: p. 165.
70. Huysman, M., Waste picking as a survival strategy for women in Indian cities. *Environment and Urbanization*, 1994. 6(2): p. 155-174.
71. Missionaries, V., The Payatas Environmental Development Programme: microenterprise promotion and involvement in solid waste management in Quezon City. *Environment and Urbanization*, 1998. 10(2): p. 55-68.
72. Carr, C. Untouchable to indispensable: the Dalit women revolutionizing waste in India. 2014 November 18, 2016]; Available from: <https://www.theguardian.com/global-development-professionals-network/2014/jul/01/india-waste-picking-women-waste-cities-urban>.
73. Deloitte. 2016 Global Manufacturing Competitiveness Index. [cited 2017 January 23]; Available from: <https://www2.deloitte.com/global/en/pages/manufacturing/articles/global-manufacturing-competitiveness-index.html#>.
74. Bionic. FLX. [cited 2017 January 23]; Available from: <http://bionic.is/flx.html>.
75. Adidas. Adidas and Parley. [cited 2017 January 23]; Available from: <http://www.adidas.com/us/parley>.
76. Sammon, A. What the Heck Is Up With California's Recycling Program? 2016 November 18, 2016]; Available from: <http://www.motherjones.com/environment/2016/08/california-recycling-program-fail>.
77. Paben, J. Houston and Waste Management agree to contract without glass. 2016 November 18, 2016]; Available from: <http://resource-recycling.com/node/7183>.

78. Recnowa. [cited 2017 January 23]; Available from: <http://recnowa.org/>.

79. Vijayaraghavan, A. San Francisco Processes 600 Tons of Compost Daily. 2011 November 18, 2016]; Available from: <http://www.triplepundit.com/2011/09/san-francisco-processes-600-tons-compost-daily/>.

80. Katz, C. Leading San Francisco's Quest To Recycle All Trash by 2020. 2014 November 18, 2016]; Available from: [http://e360.yale.edu/feature/interview\\_jack\\_macy\\_putting\\_san\\_francisco\\_on\\_the\\_road\\_to\\_zero\\_waste/2767/](http://e360.yale.edu/feature/interview_jack_macy_putting_san_francisco_on_the_road_to_zero_waste/2767/).

81. Bosmans, A., et al., The crucial role of Waste-to-Energy technologies in enhanced landfill mining: a technology review. *Journal of Cleaner Production*, 2013. 55: p. 10-23.

82. Kunwar, B., et al., Plastics to fuel: a review. *Renewable and Sustainable Energy Reviews*, 2016. 54: p. 421-428.

83. Wong, S.L., et al., Current state and future prospects of plastic waste as source of fuel: A review. *Renewable and Sustainable Energy Reviews*, 2015. 50: p. 1167-1180.

84. Astrup, T.F., et al., Life cycle assessment of thermal Waste-to-Energy technologies: Review and recommendations. *Waste Management*, 2015. 37: p. 104-115.

85. Miranda, M.L. and B. Hale, Waste not, want not: the private and social costs of waste-to-energy production. *Energy Policy*, 1997. 25(6): p. 587-600.

86. Ellen MacArthur Foundation. The New Plastics Economy: Catalyzing Action. 2017 [cited 2017 January 23]; Available from: [https://www.ellenmacarthurfoundation.org/assets/downloads/New-Plastics-Economy\\_Catalysing-Action\\_13-1-17.pdf](https://www.ellenmacarthurfoundation.org/assets/downloads/New-Plastics-Economy_Catalysing-Action_13-1-17.pdf).

87. Hickman, M. Sweden runs out of garbage, forced to import from neighbors. 2016 [cited 2017 January]; Available from: <http://www.mnn.com/lifestyle/recycling/blogs/sweden-runs-out-of-garbage-forced-to-import-from-norway>.

88. Wong, S.L., et al., Recent advances of feed-in tariff in Malaysia. *Renewable and Sustainable Energy Reviews*, 2015. 41: p. 42-52.

89. Vehlow, J., Air pollution control systems in WTE units: An overview. *Waste Management*, 2015. 37: p. 58-74.

90. China National Bureau of Statistics. Collection, Transport and Disposal of Comsumptive Wastes in Cities. 2015 [cited 2017 January 23]; Available from: <http://data.stats.gov.cn/english/easyquery.htm?cn=C01>.

91. Yep, E. Singapore's Innovative Waste-Disposal System. *The Wall Street Journal* 2015 [cited 2017 JAnuary 23]; Available from: <http://www.wsj.com/articles/singapores-innovative-waste-disposal-system-1442197715>.

92. XPrize. Ansari XPrize. [cited 2017 January 23]; Available from: <http://ansari.xprize.org/>.

93. Davies, A. Wealthy Adventurers Could Turn Space Travel Into A \$1.6 Billion Industry. 2012 [cited 2017 January 23]; Available from: <http://www.businessinsider.com/space-tourism-to-generate-16-billion-2012-10>.

94. American Millenials: Cultivating the Next Generation of Ocean Conservationists. 2015 November 18, 2016]; Available from: <https://www.packard.org/wp-content/uploads/2015/06/US-Millennials-Ocean-Conservation-Study.pdf>

95. Protecting Dolphins from Deadly Fishing Practices. 2015 November 18, 2016]; Available from: <http://savedolphins.eii.org/campaigns/dsf>.

96. Packaging Regulations. 2015 [cited 2017 JAnuary 23]; Available from: [https://www.gov.uk/government/uploads/system/uploads/attachment\\_data/file/460891/BIS-15-460-packaging-essential-requirements-regulations-gov-guidance-notes.pdf](https://www.gov.uk/government/uploads/system/uploads/attachment_data/file/460891/BIS-15-460-packaging-essential-requirements-regulations-gov-guidance-notes.pdf).

97. Waste and Resources Action Programme. Courtauld Commitment 1. 2005-2010 [cited 2016 November 18]; Available from: <http://www.wrap.org.uk/node/80>.

98. Waste and Resources Action Programme. Courtauld Commitment 2. 2010-2012 [cited 2016 November 18]; Available from: <http://www.wrap.org.uk/node/9297/>.
99. European Parliament and Council Directive on packaging and packaging waste. 1994 November 18, 2016]; Available from: <http://eur-lex.europa.eu/legal-content/EN/TXT/?uri=CELEX:01994L0062-20150526>
100. Oregon Department of Environmental Quality. International Packaging Regulations. 2005 [cited 2017 January 23]; Available from: <http://www.deq.state.or.us/lq/pubs/docs/sw/packaging/intlpkgregulations.pdf>.
101. Circular Economy Strategy: Closing the Loop – An EU action for the Circular Economy. 2016 November 18, 2016]; Available from: [http://ec.europa.eu/environment/circular-economy/index\\_en.htm](http://ec.europa.eu/environment/circular-economy/index_en.htm).
102. Shreeves, R. France says au revoir to non-biodegradable plasticware. Responsible Living 2016 [cited 2016 September 16]; Available from: <http://www.mnn.com/lifestyle/responsible-living/blogs/france-bans-non-biodegradable-plasticware>.
103. Microbead-Free Waters Act. H.R. 1321 2015 [cited 2016 November 18]; Available from: <https://www.congress.gov/bill/114th-congress/house-bill/1321>.
104. Plastic Microbeads to be banned by 2017, UK government pledges. 2016 November 18, 2016]; Available from: <http://www.bbc.com/news/uk-37263087>.
105. Plastic Microbeads: Ban The Bead! 2016 November 18, 2016]; Available from: <http://storyofstuff.org/plastic-microbeads-ban-the-bead/>.
106. Sunsppheres. 2006 November 18, 2016]; Available from: [http://www.dow.com/assets/attachments/business/pcare/sunsppheres/sunsppheres\\_powder/tds/sunsppheres\\_powder.pdf](http://www.dow.com/assets/attachments/business/pcare/sunsppheres/sunsppheres_powder/tds/sunsppheres_powder.pdf).
107. South Korea's waste management policies. 2013 [cited 2017 January 23]; Available from: <http://www.legco.gov.hk/yr12-13/english/sec/library/1213inc04-e.pdf>
108. Packaging Waste Reductions: Laws and Regulations. 2015 November 18, 2016]; Available from: <http://www.calrecycle.ca.gov/ReduceWaste/Packaging/LawsRegs.htm>.
109. The Northeast Recycling Council. Disposal Bans & Mandatory Recycling in the United States. 2011 [cited 2016 November 18]; Available from: [https://nerc.org/documents/disposal\\_bans\\_mandatory\\_recycling\\_united\\_states.pdf](https://nerc.org/documents/disposal_bans_mandatory_recycling_united_states.pdf)
110. Council of the European Union. Council Directive 1999/31/EC on the Landfill of Waste. 1999 [cited 2016 November 18]; Available from: <http://eur-lex.europa.eu/legal-content/EN/TXT/?uri=CELEX:31999L0031>.
111. Government of Nova Scotia. Materials Banned From Disposal Sites in Nova Scotia. [cited 2016 November 18]; Available from: <https://novascotia.ca/nse/waste/banned.asp>.

Learn more about  
Paul G. Allen's initiatives at:

[www.paulallen.com](http://www.paulallen.com)

---

